



Beghelli
IDEE PIENE DI VITA

REVERSO **Emergenza**
2024 Emergency

Idee piene di vita

Le idee, e quindi l'innovazione, sono alla base dell'operato di Beghelli, che dal 1982 progetta soluzioni che permettono alle persone di vivere il proprio ambiente di lavoro e di vita in serenità e salute, avendo come naturale prerequisito il rispetto dell'ambiente.

Grazie all'attenzione alle esigenze della vita reale, Beghelli è capace di anticipare le tendenze e le richieste del mercato, guidata in questo dalla consapevolezza che tutto nasce da un'intensa attività di ricerca e sviluppo.

Il benessere delle persone e dell'ambiente, il risparmio energetico, la facilità di utilizzo, sono al centro dell'attenzione di Beghelli e alla base di tutte le sue idee.

Idee piene di vita.

Ideas full of life

Ideas, and hence innovations are at the heart of Beghelli's mission. Beghelli has been designing solutions since 1982 that allow people to live and work in harmony with environment and to keep their environmentally friendly lifestyle as a natural prerequisite.

Thanks to Beghelli's attention to real-life demands, Beghelli has the capacity to anticipate market trends and requirements and is driven by the awareness that everything stems from intense research and development.

The wellbeing of people and the environment, energy saving, ease of use, are the focus of Beghelli and the basis of all its ideas.

Ideas full of life.



IDEE PIENE DI VITA

Indice

Proposte Esclusive Beghelli

■ App B.connect	006
■ NuBe Beghelli Cloud	010
■ Gestione impianto Bluetooth	008
■ Modula system.....	014
■ ArchitecturalECO	004
■ Blu technology.....	158
■ Garanzia 10 anni.....	004
■ Booster battery	005

Sistemi e apparecchi di emergenza

■ Apparecchi.....	022
■ Faretti	090
■ Architeturali	108
■ Serie civili.....	118
■ Segnaltica	126
■ Kit emergenza	146

Sistemi di controllo

■ Sistema Central Test CT	018
■ Centrali di controllo CT.....	154
■ Central System CTS.....	019
■ Sistemi a batteria centralizzata CTS.....	164
■ Schemi unifilari	020

Legenda simboli..... P.220

Indice analitico.....P.222

Condizioni generali di vendita..... P.230

Index

Exclusive Beghelli proposals

■ App B.connect	006
■ NuBe Beghelli Cloud	010
■ Managing by Bluetooth connection.....	008
■ Modula system.....	014
■ ArchitecturalECO	004
■ Blu technology.....	158
■ 10 years warranty.....	004
■ Booster battery	005

Systems and emergency luminaires

■ Luminaires.....	022
■ Spotlights.....	090
■ Architectural luminaires	108
■ Residential series.....	118
■ Exit sign.....	126
■ Emergency conversion kit.....	146

Control systems

■ CT Central Test system	018
■ CT control Units.....	154
■ CTS Central System.....	019
■ CTS Centralised battery systems	164
■ Single-line electrical diagrams	020









Key to symbols..... P.221

Analytical index P.222 |



Terms and conditions of sale..... P.230

Indice / Index



SISTEMI / SYSTEMS

TR	AT	CT
<p>Autoalimentati tradizionali</p> <p><i>Traditional self-contained</i></p>	<p>Autoalimentati con diagnosi locale, anche con connettività Bluetooth</p> <p><i>Self-contained with local diagnosis, also with Bluetooth connectivity</i></p>	<p>Autoalimentati con diagnosi centralizzata CentralTest, comunicazione dati espandibile tramite moduli opzionali: BUS LG, DALI, radio LGFM</p> <p><i>Self-contained with centralized CentralTest diagnosis, data communication expandable via optional modules: LG BUS, DALI, LGFM radio</i></p>
 	 	   
TRADIZIONALI TRADITIONAL	AUTOTEST	CENTRALTEST SELF TESTING





CENTRALI DI SUPERVISIONE - NUBE BEGHELLI CLOUD / CONTROL UNIT - NUBE BEGHELLI

 <p>BEGHELLI CLOUD</p> <p>P. 010</p>	 <p>Controllo/Control CBL-LG-LGFM</p> <p>CT</p> <p>P. 154</p>	 <p>Supervisione/Supervision LG-EPS</p> <p>CT CTS</p> <p>P. 160</p>
--	---	---

APPARECCHI / LUMINAIRES

 <p>Logica</p> <p>IP65</p> <p>CT, CTS, HT</p> <p>P. 022</p>	 <p>Acciaio emergenza</p> <p>IP66</p> <p>Ex</p> <p>CT, CTS, HT</p> <p>P. 026</p>	 <p>Pratica Modula Matrix</p> <p>IP65</p> <p>Bluetooth</p> <p>CT, CTS, HT</p> <p>LDM DCO</p> <p>P. 028</p>
 <p>Pratica Modula</p> <p>IP65-IP42</p> <p>Bluetooth</p> <p>TR, AT, CT, CTS</p> <p>LDM DCO</p> <p>P. 032</p>	 <p>Infinita</p> <p>IP65-IP20</p> <p>CT, CTS, HT, Sanifica</p> <p>ARIA logo</p> <p>P. 036</p>	 <p>Formula 65</p> <p>IP65 - IP20</p> <p>TR, AT, CT, CTS, HT, Sanifica</p> <p>ARIA logo</p> <p>P. 048</p>
 <p>Metrica</p> <p>IP65</p> <p>CT, CTS, HT</p> <p>P. 054</p>	 <p>Lumax 65</p> <p>IP65</p> <p>CT, CTS, HT</p> <p>P. 056</p>	 <p>Blu</p> <p>IP42</p> <p>TR, AT</p> <p>P. 058</p>
 <p>Completa</p> <p>IP66 - IP40</p> <p>TR, AT, CT</p> <p>P. 062</p>	 <p>UpLED</p> <p>IP65-IP42</p> <p>TR, AT, CT</p> <p>P. 066</p>	 <p>Pratica IP65</p> <p>IP65 - IP20</p> <p>TR, AT, Sanifica</p> <p>ARIA logo</p> <p>P. 070</p>
 <p>Pratica IP42</p> <p>IP42</p> <p>TR, AT</p> <p>P. 076</p>	 <p>Ticinque</p> <p>IP65 - IP42</p> <p>TR, AT</p> <p>P. 080</p>	 <p>Stile In</p> <p>IP40 - IP20</p> <p>TR, Sanifica</p> <p>ARIA logo</p> <p>P. 086</p>

FARETTI / SPOTLIGHTS

 <p>Lungalargaluce Extreme</p> <p>IP65</p> <p>Ex</p> <p>AT, CT, CTS, HT</p> <p>P. 090</p>	 <p>Lungalargaluce plafone/incasso</p> <p>IP42</p> <p>CT, CTS, HT</p> <p>P. 094-098</p>	 <p>Multi Lens</p> <p>IP42</p> <p>TR, AT, CT, CTS, HT</p> <p>P. 102</p>
 <p>Triangle</p> <p>IP66</p> <p>CT, CTS, HT</p> <p>P. 106</p>		

CTS

LG230 Alimentazione e diagnosi centralizzata da Centrale 216Vdc

Centralized power supply and diagnosis from 216Vdc Control unit



LG24 Alimentazione e diagnosi centralizzata da Centrale 24Vdc

Centralized power supply and diagnosis from 24Vdc Control unit



LG EPS Alimentazione e diagnosi centralizzata 230 Vac da soccorritore EPS.

Centralized 230 Vac power supply and diagnosis from EPS static inverter.



CENTRALSYSTEM - BATTERIA CENTRALIZZATA
CENTRALSYSTEM - CENTRALIZED BATTERY

HT

Apparecchi alimentabili da tensione di rete, da soccorritori o da sistema LG230.

Devices that can be powered from mains voltage, from static inverter or from the LG230 system.

RETE - BATTERIA CENTRALIZZATA
MAINS POWER - CENTRALIZED BATTERY

CLOUD



**Controllo/Control
LG230 - LG24**

CTS

P. 164



**Controllo/Control
EPS Eco**

IP20

CTS

P. 202-206



**Controllo/Control
EPS Pro**

IP20

CTS

P. 202-212

ARCHITETTURALI / ARCHITECTURAL LUMINAIRES



Nu.da

IP42

TR, AT, CT

P. 108



Design

IP40

TR

P. 110



Dot

IP65

TR, CT, CTS, HT

P. 112



Design Flag

IP40

TR, AT, CT, CTS, HT

P. 116

SERIE CIVILI / EMERGENCY LUMINAIRES FOR WIRING SYSTEMS



**Tutti Frutti
Fruttoluce**

IP40

TR

P. 118-120



Linea 500

IP40

TR

P. 122



**Placca Brain
Classic Emergenza**

IP20

TR

P. 124

SEGNALETICA / EXIT SIGNS



Ironflag IP65

IP65

TR, AT, CT, CTS, HT

P. 126



Ironflag

IP40

TR, AT, CT, CTS, HT

P. 128



Exit

IP40

TR, AT, CT, CTS, HT

P. 132



**UpLED Bandiera
IP65**

IP65

TR, AT, CT

P. 136



Sign

IP40

CT, CTS, HT

P. 138



Dispos evo

IP40

CT, CTS, HT

P. 140



Quader

IP42

CT, CTS, HT

P. 142



Piana

IP40

CT, CTS, HT

P. 144

KIT DI CONVERSIONE IN EMERGENZA / EMERGENCY CONVERSION KIT



Inverter Universale

IP65 - IP20

AT, CT

P. 146



Inverter LED

IP65 - IP20

CT

P. 148



**Inverter LED
Plug&Light**

IP65 - IP40

TR

P. 152

Proposte esclusive Beghelli / Exclu

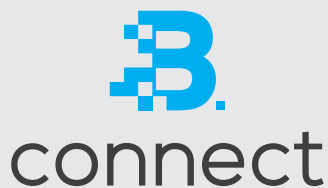

P. 006

App per la gestione dei sistemi di controllo di tutti gli apparecchi autoalimentati. Consente di accedere direttamente all'apparecchio, alla centrale oppure alla piattaforma NuBe Beghelli Cloud, riconoscendo automaticamente il sistema di controllo dell'apparecchio.

An application for managing the control systems of all self-contained appliances. It allows direct access to the appliance, the control unit or the NuBe Beghelli Cloud platform, and automatically recognise the appliance's control system.



P.010

NuBe è la piattaforma in Cloud unica di accesso e gestione di tutti gli impianti Beghelli che permette di gestire e tenere sotto controllo illuminazione e illuminazione di emergenza, in cui sarà attivabile anche il servizio di manutenzione predittiva.

NuBe is a unique Cloud platform for accessing and managing all Beghelli systems which allows you to manage and monitor lighting and emergency lighting, where the predictive maintenance service can also be activated.

**10 ANNI DI GARANZIA
SU TUTTI I COMPONENTI**



In tutti gli apparecchi CentralTest CT, vengono utilizzati accumulatori che assicurano elevata vita utile ed un'esteso campo di temperature di esercizio. Gli apparecchi che integrano questa tecnologia, sono garantiti 10 anni.

In all CentralTest CT devices, accumulators are used to ensure a long useful life and an extended operating temperature range. Devices that integrate this technology are guaranteed for 10 years.



Concept innovativo che permette di far "scompare" gli apparecchi installati grazie ad un trattamento che ne consente la verniciabilità, oltre al ridotto impatto ambientale grazie all'utilizzo di materiali rinnovabili, materie prime riciclate o biodegradabili e compostabili.

Innovative concept that allows the installed appliances to "disappear", thanks to their condition that allows them to be painted. Other than that, the use of renewable materials, recycled or biodegradable and compostable raw materials also reduce environmental impact.

sive Beghelli proposals



P. 014

Sistema di installazione che integra nell'apparecchio una staffa di derivazione capace di contenere i cablaggi elettrici, la bolla di livello, una morsettiera estraibile.

La staffa, nelle versioni CT, può alloggiare un modulo di controllo (LG o LGFM o DALI).

Installation system that integrates a junction bracket into the appliance allowing the containing of electrical wiring, the level bubble, an extractable terminal block.

The bracket, in the CT versions, can house a control module (LG or LGFM or DALI).



P. 008

I nuovi apparecchi AT sono equipaggiati di serie con un'interfaccia Bluetooth BLE. Una tecnologia che permette di regolare tutti i parametri lampada (autonomia, flusso e test diagnostici), senza dover aprire l'apparecchio. Da App B.connect si trasferiscono i dati sulla piattaforma NuBe Beghelli Cloud.

The new AT devices are equipped as standard with a Bluetooth BLE interface. A communication technology that allows you to adjust all lamp parameters (autonomy, flux and diagnostic tests), without having to open the device. From the B.connect App, data is transferred to the NuBe Beghelli Cloud platform.



P. 058

Tecnologia che integra, nell'emergenza tradizionale a luce bianca, una notturna blu ad emissione calibrata per una luce riposante e sicura. L'alimentazione del sistema viene ricavato "a costo zero" dal surplus di energia per la ricarica delle batterie.

Technology that integrates, in the traditional white light emergency, a blue night light with calibrated emission for a restful and safe light. The system's power is obtained "at zero cost" from the surplus energy for recharging the batteries.



Seconda batteria opzionale per incrementare notevolmente il flusso luminoso (lm) emesso dall'apparecchio, assicurando almeno un 50% in più, rispetto allo stesso apparecchio dotato solamente della batteria in dotazione.

Second optional battery that significantly increases the luminous flux (lm) emitted by the luminaire, ensuring at least 50% more compared to the same luminaire equipped only with the supplied battery.

Gestione impianto da remoto e in loco

emergenza / emergency

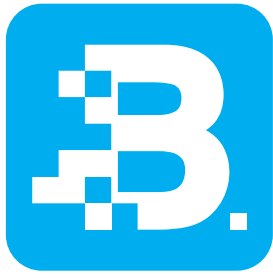

B.connect

App univoca che permette di accedere direttamente all'Apparecchio, alla Centrale oppure alla piattaforma NuBe Beghelli Cloud.

Single App to manage all control systems of Beghelli self-contained luminaires. It allows direct access to the luminaires, to the control unit or to the Beghelli NuBe Cloud platform.



QR INFO



ACCESSO ALL'IMPIANTO DA CLOUD BEGHELLI SYSTEM ACCESS BY THE BEGHELLI CLOUD

L'APP consente l'accesso diretto alla piattaforma NuBe. Diventano subito disponibili tutte le funzioni di programmazione, controllo remoto e consultazione dei logbook impianto.

The APP allows direct access to the NuBe platform. All programming, remote control and system logbook view functions become available immediately.



COMUNICAZIONE DIRETTA CON LA CENTRALE COMMUNICATION WITH THE CONTROL UNIT

B.connect è strutturata per la lettura diretta del QR code della Centrale, riconoscendone l'identificativo e il tipo di sistema di controllo (CBL, LG, LGFM). La comunicazione in WiFi locale non necessita di connessione WEB.

B.connect is equipped with QR code reading of the control unit which contains the identification number and the type of the control system (CBL, LG, LGFM). All communication is done through WIFI, no WEB connection needed.



COMUNICAZIONE OTTICA O BLUETOOTH CON L'APPARECCHIO / ACCESS THROUGH OPTICAL OR BLUETOOTH COMMUNICATION

Comunicazione con gli apparecchi attraverso impulsi luminosi dal flash dello smartphone. I comandi impostabili riguardano la programmazione dei parametri lampada, dei test di funzionamento e i comandi negli apparecchi ibridi della serie SanificaAria.

Directly communicate with the luminaires via the smartphone flash. The commands that can be set are program lamp parameters and conducting functional tests.



le / Remotely and locally managed



QR INFO APPARECCHIO

QR LUMINAIRES INFO

Tutti gli apparecchi Beghelli dispongono di un QR code identificativo per l'accesso diretto alla pagina specifica del WEB CATALOGUE, e al relativo foglio istruzioni.

All Beghelli devices have an identifying QR code for direct access to the specific WEB CATALOGUE page and the instruction sheet.



TEST LAMPADA

LAMP TEST

Ogni apparecchio dotato di fotosensore intelligente può ricevere il comando ottico di attivazione dei test funzionali e di autonomia previsti dalle normative vigenti.

Each device is equipped with an intelligent photosensor that can receive the optical command to activate the functional and autonomy tests required by current regulations.



Comunicazione ottica fra il flash dello Smartphone e il fotosensore intelligente integrato negli apparecchi di emergenza compatibili.

Optical communications between the smartphone flash and the intelligent light sensor integrated in compatible emergency luminaires.

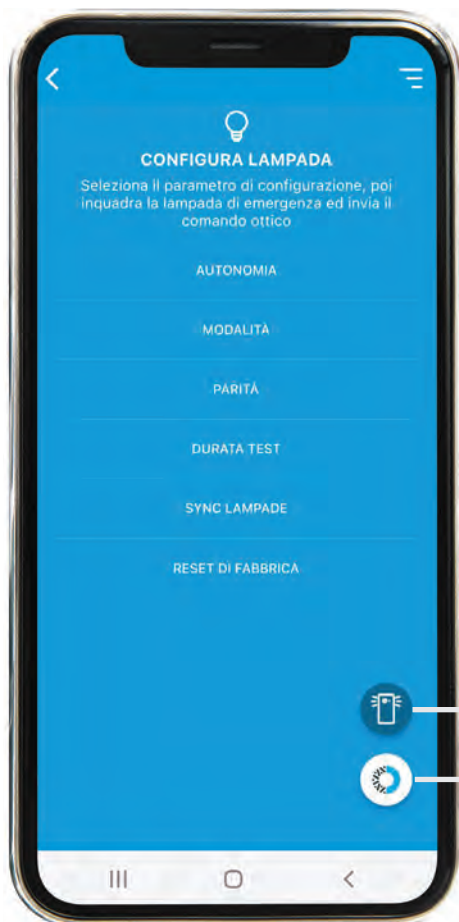

SANIFICAZIONE DELL'ARIA

SANIFICAZIONE DELL'ARIA

Gli apparecchi della serie SanificaAria, sono dotati di fotosensore intelligente in grado di ricevere i comandi luminosi per la regolazione dei parametri di sanificazione.

The SanificaAria luminaires are equipped with an intelligent photosensor capable of receiving light commands that allow the regulation of the sanitization parameters.



Gestione impianto tramite Bluetooth /

emergenza / emergency

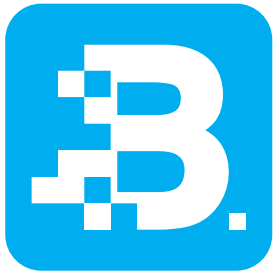

B.connect

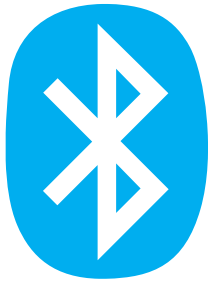

Trasformazione da impianto Autotest AT in Centraltest CT a "costo zero"

Modify from Autotest AT system to Centraltest CT at "zero cost"

UN NUOVO CONCETTO DI CENTRALIZZAZIONE IMPIANTO A NEW CONCEPT OF CENTRAL SYSTEM

Le nuove gamme di apparecchi per illuminazione di emergenza Beghelli sono equipaggiate di serie con un'interfaccia Bluetooth Low Energy. Questa tecnologia permette di regolare tutti i parametri lampada come autonomia, flusso e avviare un test diagnostico, senza dover aprire l'apparecchio. Da oggi è sufficiente avviare la ricerca degli apparecchi da App B.connect per raccogliere tutti i dati e trasferirli sulla piattaforma NuBe Beghelli Cloud. Con la nuova tecnologia Bluetooth, gli impianti saranno sempre accessibili, sia localmente con gli apparecchi in visibilità bluetooth, che da remoto tramite il Cloud NuBe Beghelli. Grazie a questa innovazione, un semplice impianto AutoTest AT, composto da apparecchi Bluetooth, acquisisce le funzionalità di un impianto CentralTest CT.

The new ranges of Beghelli emergency lighting luminaires are equipped with a standard interface Bluetooth Low Energy. This technology allows you to adjust all lamp parameters such as autonomy, flux and start a diagnostic test, without opening the luminaire. All you need to do is connecting luminaires by B.connect App to collect all the data and transfer them to the NuBe Beghelli Cloud platform. With the new Bluetooth technology, the systems will always be accessible, both locally from the App and remotely from the NuBe Beghelli Cloud. Thanks to this innovation, a simple AutoTest AT system, composed of Bluetooth devices, acquires the functionality of a CentralTest CT system.



CREAZIONE E GESTIONE IMPIANTI BLUETOOTH

MAKING AND MANAGEMENT OF BLUETOOTH SYSTEMS

Con l'accesso alla sezione NuBe cloud è possibile gestire tutti gli impianti, sia centralizzati, che i nuovi impianti bluetooth. In questa schermata è inoltre possibile creare un nuovo impianto bluetooth.

With the access to the Nube cloud section, it is possible to manage all systems, both centralized and new Bluetooth systems. It is also possible to create new Bluetooth system on the same screen.

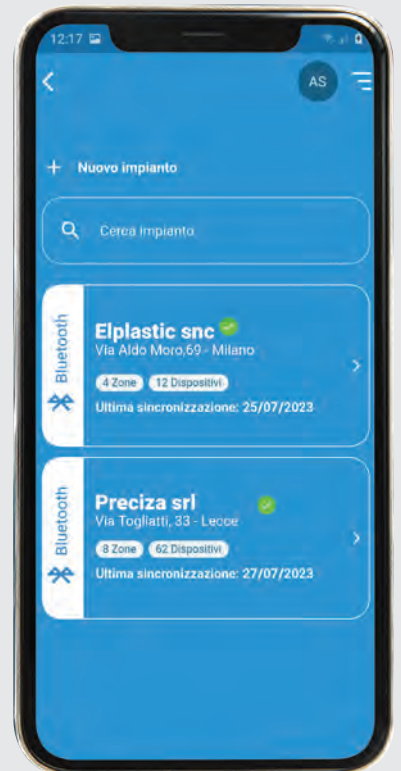

Managing by Bluetooth connection

LA GESTIONE E LE PROCEDURE DI MANUTENZIONE E CONTROLLO SONO IMMEDIATE MANAGEMENT AND MAINTENANCE PROCEDURES ARE IMMEDIATE

Con la App B.connect è possibile avviare la ricerca degli apparecchi per poi inserirli nel nuovo impianto. I parametri delle lampade possono essere modificati localmente attraverso l'App B.connect, e salvati in remoto sulla piattaforma NuBe Beghelli Cloud. Successivamente, attivando la funzione di manutenzione, la procedura di ricerca contrassegnando visivamente le lampade rilevate rispetto a quelle ancora fuori portata: camminando all'interno dell'area gli apparecchi, vengono rilevati man mano che entrano nel raggio d'azione del Bluetooth. Completata questa fase è possibile creare il report impianto (LogBook) e salvarlo sulla piattaforma NuBe Beghelli Cloud.

With the B.connect App, it is possible to start connecting luminaires and then insert them into the new system. The lamp parameters can be modified locally through the B.connect App, and saved remotely on the NuBe Beghelli Cloud. By activating the connecting mode, the system will automatically detects lamps that don't fall in the parameters: by walking inside the area where the luminaires are located, the luminaires are detected as they come within range of the bluetooth. Once this phase has been completed, it is possible to create the system report (LogBook) and save it on the NuBe Beghelli Cloud platform.

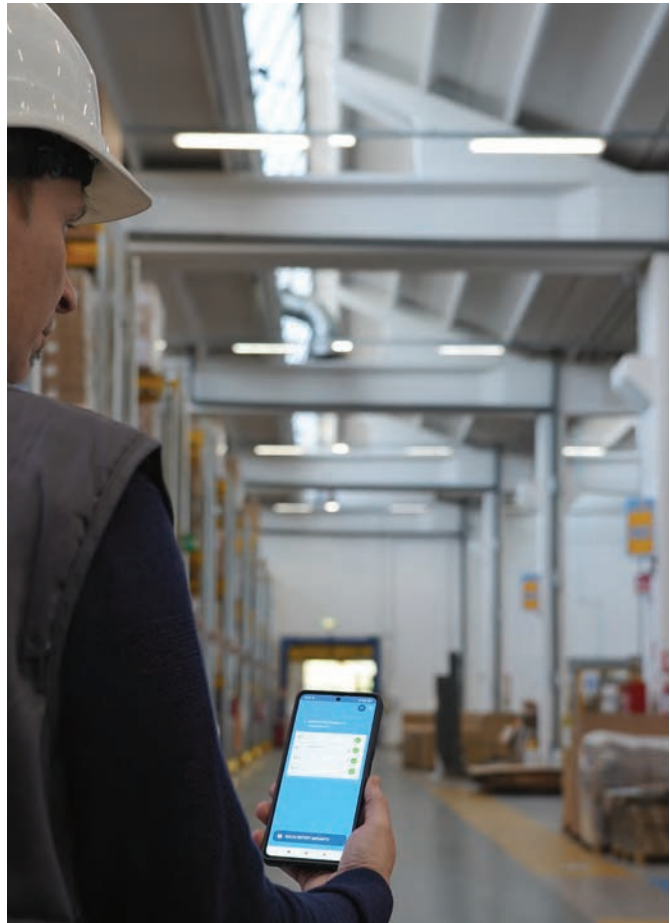

GESTIONE DELLE ZONE E DEGLI APPARECCHI ZONE AND LUMINAIRES MANAGEMENT

Ogni impianto Bluetooth è suddiviso in zone. L'app consente di esplorare le varie zone e di crearne nuove. Ogni zona riporta l'elenco dei dispositivi associati.

Each Bluetooth system is divided into zones. The app allows you to explore various areas and also allows you to make new ones. Each zone contains a list of associated devices.

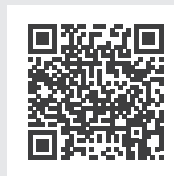

GUARDA IL VIDEO DI PRESENTAZIONE
WATCH THE VIDEO

B.connect

Gestione e archivio impianti da Cloud

emergenza / emergency



NUBE BEGHELLI CLOUD, IL POSTO GIUSTO PER I TUOI IMPIANTI BEGHELLI NUBE CLOUD, THE RIGHT PLACE FOR YOUR SYSTEMS

NuBe è la piattaforma in Cloud di accesso e gestione di tutti gli impianti Beghelli. A disposizione di tutti gli installatori ed utilizzatori di impianti Beghelli, permette di gestire e tenere sotto controllo sia l'illuminazione che l'illuminazione di emergenza, sia per gli apparecchi autoalimentati che per quelli con batteria centralizzata. Disponibile gratuitamente in versione Basic oppure nella versione Professional che permette di estendere ulteriormente le già numerose possibilità della piattaforma, come ad esempio la manutenzione predittiva, funzione in grado di anticipare all'utilizzatore interventi di manutenzione all'impianto in modo da prevenire malfunzionamenti.

NuBe is the Cloud platform that allows access and management of all Beghelli systems. Available to all Beghelli system installers and users, it allows you to manage and control both lighting and emergency lighting, both for self-contained luminaires and for centralised battery luminaires. Available for free of charge in the Basic version or in the Professional version, where extended possibilities including predictive maintenance are added to the platform. This can anticipate the user's maintenance operations to prevent malfunctions.

MASSIMA SICUREZZA DEI DATI E DISPONIBILITÀ ANCHE IN ASSENZA DI CONNESSIONE YOUR SYSTEM DATA ARE SAFE AND ALWAYS AVAILABLE



I dispositivi Beghelli si connettono alla piattaforma NuBe in modalità sicura tramite crittografia end-to-end che garantisce elevati standard di sicurezza. Il funzionamento è garantito anche in assenza di connettività: le centrali raccolgono i dati dall'impianto in autonomia, la pubblicazione su NuBe avviene appena si ristabilisce la connessione ad internet.

Beghelli devices are surely connected to the NuBe platform via end-to-end encryption, which guarantees high security standards. Operation is guaranteed even in the absence of connectivity, the control units autonomously collect data from the system, and publish local data on the NuBe as soon as the internet connection is restored.

/ Manage and archive your systems

FUNZIONI AVANZATE NUBE PRO / NUBE PRO ADVANCED FEATURES

La versione NuBe PRO, estende ulteriormente le caratteristiche del portale. Non ci sono più limiti al numero di centrali collegabili, e quindi di apparecchi, che possono essere anche di sistemi di controllo differenti, sia emergenza che illuminazione (CBL+LG+LGFM+SD). Eseguendo l'upgrade alla versione NuBe PRO è possibile accedere a servizi evoluti come l'inserimento di apparecchi di emergenza su foto o piante degli ambienti, lo storico illimitato dei LogBook e la manutenzione predittiva in grado di anticipare malfunzionamenti, prevedendo con anticipo gli interventi di manutenzione necessari al corretto funzionamento del sistema. **La versione NuBe PRO necessita di servizio di attivazione.**

The NuBe PRO version further extends the features of the portal. There is no longer any limit to the number of control units that can be connected, and as well as the number of luminaires, which can also be from different control systems, both for emergency lighting and lighting (CBL+LG+LGFM+SD). Upgrading to the NuBe PRO version offers access to advanced services such as the insertion of emergency luminaires on photos or room plans, unlimited LogBook history and predictive maintenance capable of anticipating malfunctions, foreseeing the maintenance interventions needed for a correct operation of the system. **NuBe PRO version requires activation service**

	NuBe	NuBe PRO
NUMERO MAX APPARECCHI PER IMPIANTO MAX. NUMBER OF LUMINAIRES PER SYSTEM	256	NESSUN LIMITE NO LIMITS
* GESTIONE IMPIANTI MULTISISTEMA MULTI-SYSTEM MANAGEMENT	✗	✓
SISTEMA E N° MAX CENTRALI PER IMPIANTO SYSTEM AND MAX. N° OF CONTROL UNITS	N.8 CBL Cablecom in alternativa / <i>alternatively</i> N.2 LG Compact in alternativa / <i>alternatively</i> N.1 LGFM Compact	Nessun limite di N° / <i>No limit on the N° of</i> CBL Cablecom - LG Compact LGFM Compact - LGFM SD Logica
STORICO LOGBOOK IMPIANTO SYSTEM LOGBOOK HISTORY	12 MESI	✓
MANUTENZIONE PREDITTIVA PREDICTIVE MAINTENANCE	✗	✓
GESTIONE FOTO AMBIENTI ROOM PHOTO MANAGEMENT	✗	✓
GESTIONE PLANIMETRIE PLANIMETRY MANAGEMENT	✗	✓
GESTIONE RICAMBI SPARE PART MANAGEMENT	✗	✓
GESTIONE NOTIFICHE NOTIFICATION MANAGEMENT	BASE / BASIC	AVANZATE / ADVANCED

* Opzione valida sia per i sistemi di controllo dell'emergenza CT e CTS, che per gli impianti di illuminazione SD
 Option valid both for CB - LG - LGFM emergency control systems and for SD lighting systems

SEGUE >

NuBe, il controllo completo e intuitivo

emergenza / emergency

MONITORAGGIO TRAMITE DASHBOARD SMART / MONITORING BY SMART DASHBOARD

La videata principale consente di monitorare la composizione e lo stato dell'impianto in tempo reale, attraverso widget di rapida consultazione che ne visualizzano la localizzazione, l'esito dei test di autonomia ed il controllo generale di tutti i dispositivi. Le procedure di gestione e controllo sono intuitive grazie ad una composizione grafica dettata dall'utilizzo che evidenzia il numero di centrali e di apparecchi presenti, quantifica i dispositivi funzionanti correttamente, quelli non raggiungibili e quelli in errore. Eventuali anomalie vengono evidenziate per una rapida soluzione dei problemi e i grafici personalizzabili mostrano l'andamento dell'impianto analizzando i test automatici.

The main page allows you to monitor the composition and status of the system in real time, through quick consultation widgets that display its location, the results of the autonomy tests and the general control of all the devices. The management and control procedures are intuitive thanks to a graphic composition dictated by usage which highlights the number of control panels and devices present, quantifies the correctly functioning devices, unreachable, and devices in error. Any anomalies are highlighted for rapid problem solving and the customizable graphs show the progress of the system by analyzing the automatic tests.

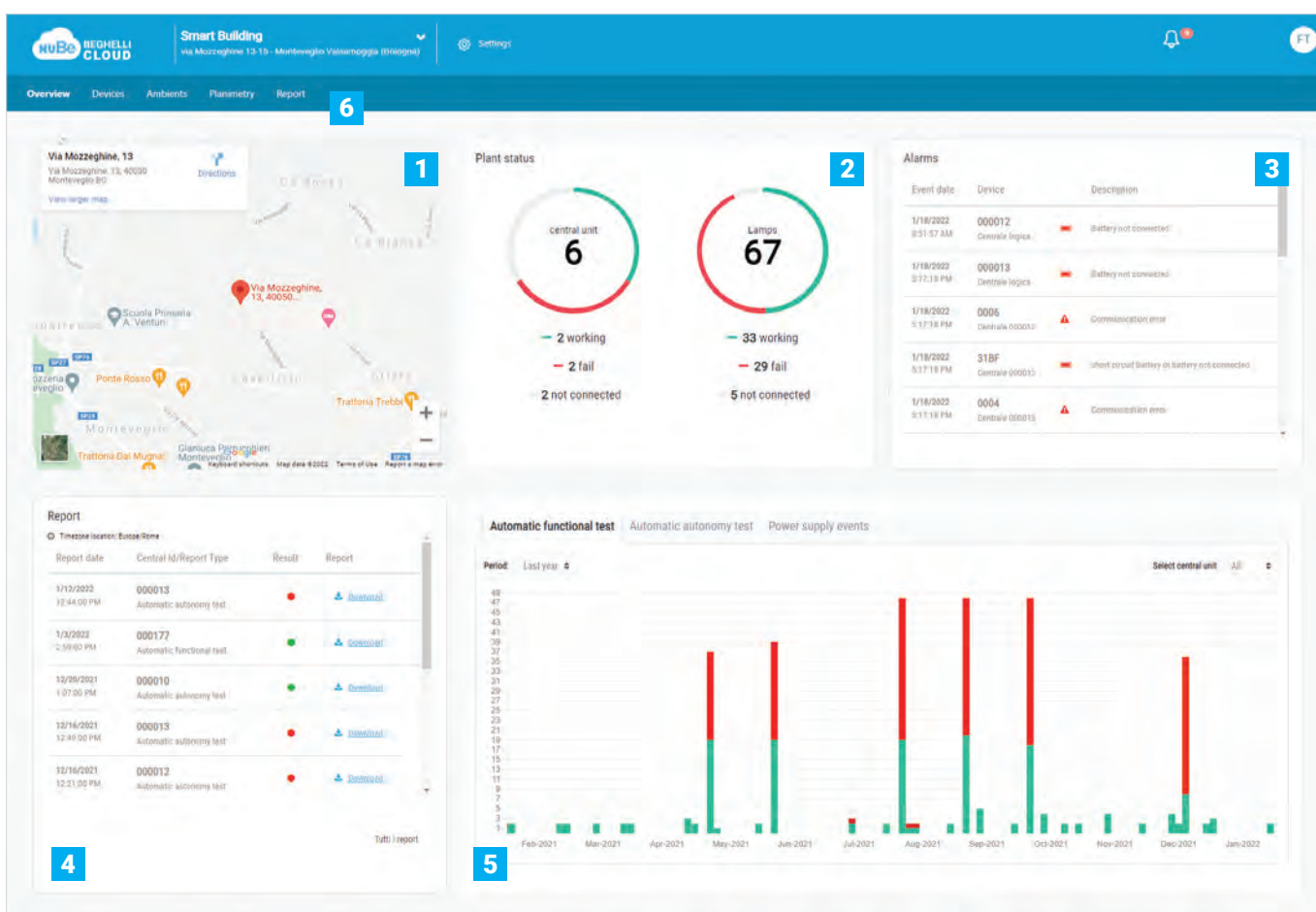

DESCRIZIONE AREE DASHBOARD / DESCRIPTION OF DASHBOARD AREAS

1 IDENTIFICAZIONE IMPIANTO PLANT IDENTIFICATION

Posizionamento preciso dell'impianto con geolocalizzazione e mappa dinamica.

Precise position of the system with geolocation and dynamic map.

2 STATO DELL'IMPIANTO SYSTEM STATUS

Stato impianto con grafico dinamico live, segnalazione di eventuali anomalie generali.

System status with live dynamic graph, reporting any general anomalies.

3 EVIDENZA ALLARMI ATTIVI EVIDENCE OF ACTIVE ALERTS

Identificazione del dispositivo, posizione e tipologia dell'errore.

Device identification, location and type of error.

/ complete and intuitive control

FUNZIONI AVANZATE NUBE PRO / ADVANCED FEATURES NUBE PRO

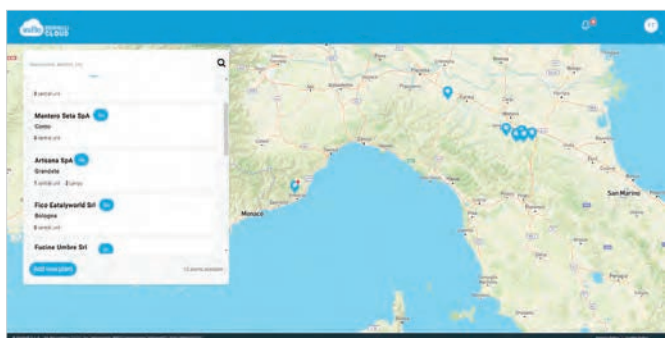

PANORAMICA IMPIANTI / PLANT OVERVIEW

Visualizzazione globale con monitoraggio di tutti gli impianti geolocalizzati sul territorio ed evidenza di eventuali errori.

Global visualization with monitoring of all geolocalised systems in the area and evidence of any errors.



INTEGRAZIONE CON IMMAGINI / INTEGRATION WITH IMAGES

Rapido posizionamento degli apparecchi su planimetrie o foto ambienti ,in formato jpeg, direttamente da NuBe.

Quick luminaires positioning on the floor plans or room images, in jpeg format, directly from NuBe.

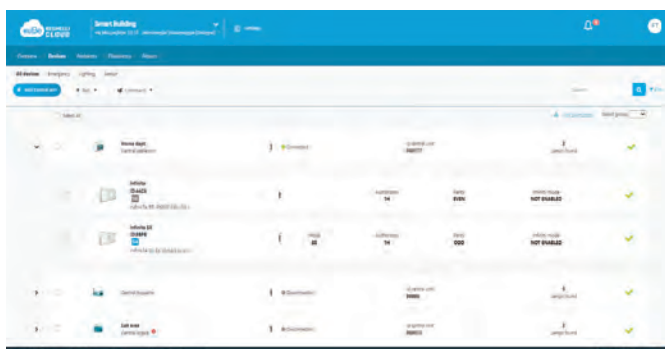

IMPIANTO AGGREGATO / AGGREGATED SYSTEM

E' possibile aggregare in cloud un unico impianto di più centrali di diverso tipo. Le centrali e le lampade correlate vengono mostrate nella classica visualizzazione ad albero mostrando alert e dettagli di configurazione.

Cloud aggregation of a single system with multiple different types of control systems. The control units and related lamps are shown in the classic tree view displaying alerts and configuration details.

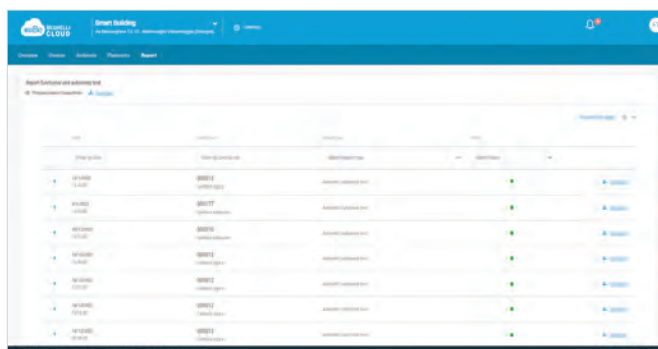

REPORT IMPIANTO / SYSTEM REPORT

Ogni test funzionale o di autonomia pianificato genera automaticamente un report consultabile dalla piattaforma NuBe e scaricabile in formato pdf con archiviazione automatica di tutti i report ed invio automatico di eventuali alert.

Each planned functional or autonomy test automatically generates a report that can be consulted from the NuBe platform and downloaded in PDF format with automatic archiving of all reports and automatic sending of any alerts.

4 REPORT IMPIANTO SYSTEM REPORT

Evidenza degli ultimi report relativi ad anomalie, test o corretto funzionamento di ogni singolo apparecchio.

Evidence of the latest reports relating to anomalies, tests or correct functioning of each individual device.

5 RISULTATI DEI TEST AUTOMATICI AUTOMATIC TEST RESULTS

Un grafico a blocchi mette a confronto i vari test secondo la personalizzazione che si è impostata (per es. Mesi/Anno).

A block graph compares the various tests according to the customization you have set (e.g. Months/Year).

6 BARRA DI NAVIGAZIONE NAVIGATION BAR

Per passare dalla visione generale di Overview ad apparecchi e centrali, Ambienti, Planimetrie e Report.

To switch from the general overview of Devices and control units, overview Rooms, Floor Plans and Reports

Modula system: staffa di derivazione in

emergenza / emergency

IL SISTEMA CHE DIMEZZA I TEMPI DI INSTALLAZIONE THE SYSTEM TO HALF INSTALLATION TIMES

Utilizzare gli apparecchi Modula Beghelli porta ad una notevole semplificazione dell'impianto e ad una conseguente drastica riduzione dei tempi di realizzazione dello stesso. La possibilità di non utilizzare scatole di derivazione è il focus della nuova metodologia di installazione: le scatole di derivazione tradizionali vengono sostituite dalle staffe di derivazione EasyBOX, integrate in ogni apparecchio Modula. All'interno della staffa è presente uno spazio maggiorato per l'alloggiamento dei cavi e la morsettiera estraibile permette un cablaggio veloce e sicuro. Diventa inoltre estremamente agevole l'utilizzo del cablaggio passante. Anche la manutenzione è semplificata: tutti gli apparecchi della serie Modula possono essere sganciati dalla staffa di derivazione EasyBox e quindi maneggiati comodamente con estrema semplicità.

Using Modula Beghelli devices leads to a notable simplification of the system and a consequent drastic reduction in its construction times. The possibility of not using junction boxes is the focus of the new installation methodology: traditional junction boxes are replaced by EasyBOX junction brackets, integrated into each Modula appliance. Inside the bracket there is an increased space for storing cables and the extractable terminal block that allows quick and safe wiring.. Furthermore, the use of pass-through wiring becomes extremely easy. Maintenance is also simplified: all the devices of the Modula series can be detached from the EasyBox junction bracket and therefore handled comfortably with extreme simplicity.



EASY-BOX, IL CUORE DEGLI APPARECCHI MODULA

Tutti gli apparecchi della serie Modula contengono Easy-BOX, il sistema composto da due staffe che si incastrano l'una sull'altra creando una scatola di derivazione completa, utilizzabile anche come copertura dei cablaggi durante le fasi di cantiere. Ogni singolo guscio può ospitare la morsettiera estraibile e la bolla di livello, oltre ai componenti di espansione del sistema come i moduli di comunicazione LG, LGFM e DALI e la Booster Battery (batteria supplementare per aumentare il flusso luminoso del 50%).



EASY-BOX, THE HEART OF MODULA LUMINAIRES

All the luminaires in the Modula series contain Easy-BOX, the system made up of two brackets that fit together to create a complete junction box, which can also be used to cover the wiring during construction phases. Each single shell can house the removable terminal block and the level bubble, as well as the system expansion components such as the LG, LGFM and DALI communication modules and the Booster Battery (additional battery to increase the luminous flux up to over 50%).

tegrata / integrated junction bracket

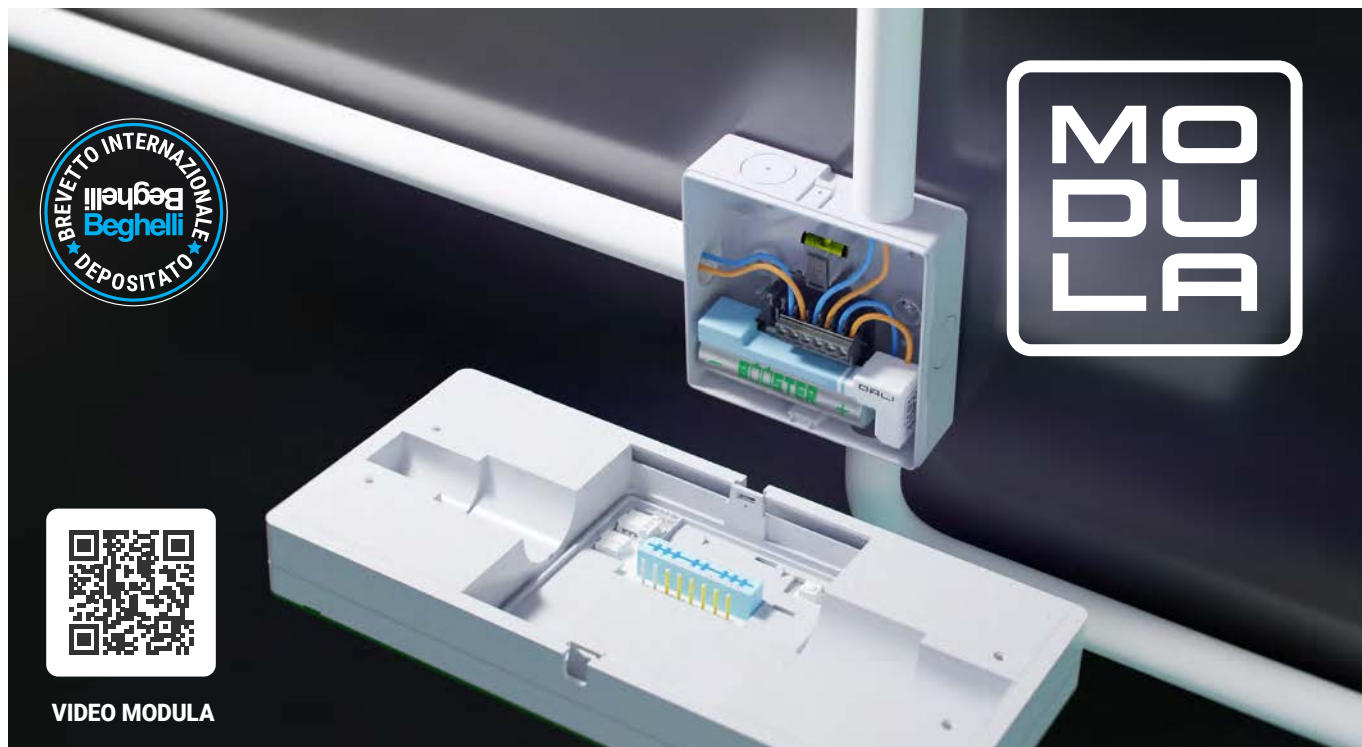

ENERGIA E FLUSSO / POWER AND FLUX

La batteria Booster può essere integrata all'interno della staffa Modula per aumentare il flusso luminoso di oltre il 50%.
The Booster battery can be integrated inside the Modula bracket to increase the luminous flux up to over 50%.



DATI SISTEMA CT / CT DATA SYSTEM

Moduli integrativi per passare da Cablecom a LG, LGFM o DALI, senza dover aprire l'apparecchio.
Supplementary modules to switch from Cablecom to LG, LGFM or DALI, without having to open the luminaire.

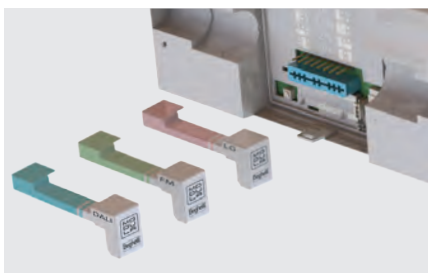

SISTEMA CTS / CTS SYSTEM

Modulo sostitutivo CTS per apparecchi HT. Trasforma il sistema di controllo in LG230 o LG24.
CTS replacement module for HT devices. Transform the control system into LG230 or LG24.

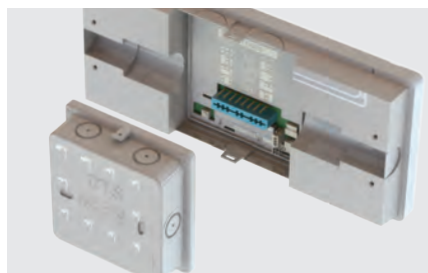

2 APPARECCHI, STESSA STAFFA EASY-BOX / 2 APPARECCHI, STESSA STAFFA EASY-BOX



PRATICA MODULA

Disponibile in versione TR, AT, CT, CTS, con programmazione dell'autonomia (1h-1,5h-2h-3h-8h) e alloggiamento per la Booster Battery per raggiungere fino ad oltre 2000lm.
Available in TR, AT, CT, CTS versions, with autonomy programming (1h-1.5h-2h-3h-8h) and housing for the Booster Battery to reach up to over 2000lm.



PRATICA MODULA MATRIX

Apparecchio CT capace di un Flusso luminoso fino a 3000lm, dotato di 24 LED a mappatura variabile con 5 emissioni luminose selezionabili da APP o Centrale.
CT luminaire capable of a luminous flux of up to 3000lm, equipped with 24 variable mapping LEDs with 5 light emissions customisable from the APP or Control unit.

Guida ai sistemi di controllo / Guide

DALLA DIAGNOSI LOCALE ALLA AUTODIAGNOSI CON CONTROLLO CENTRALIZZATO FROM LOCAL DIAGNOSIS TO SELF-DIAGNOSIS WITH CENTRALIZED CONTROL

Gli apparecchi di emergenza Beghelli, sempre in conformità con EN 50171, EN 50172, EN 62040-1-1, EN 62040-2, sono disponibili in diverse modalità di controllo. **TR** indica apparecchi in versione tradizionale con controllo locale della batteria, **AT** sono apparecchi con diagnosi locale di tutte le funzioni dell'apparecchio, **CT** sono apparecchi CentralTest autoalimentati già idonei per la connessione in un impianto centralizzato a tecnologia **CBL** Cablecom (il BUS di controllo sfrutta la rete elettrica esistente) e sono a loro volta espandibili con i relativi moduli opzionali a **LG** (Logica), **LGFM** (Logica radio FM) e **DALI**, **CTS** sfruttano invece un sistema a batteria centralizzata, sia a bassa, **LG24** (Logica 24V), che ad alta tensione **LG230** (Logica 230V) ed **LG EPS**.

Beghelli emergency luminaires, always in compliance with EN 50171, EN 50172, EN 62040-1-1, EN 62040-2, are available in different control modes. TR indicates devices in the traditional version with local battery control, AT are devices with local diagnosis of all the functions of the device, CT are self-contained CentralTest devices already suitable for connection in a centralized system with CBL technology (the control BUS uses the existing electrical network) and are in turn expandable with the relevant optional modules to LG (Logica), LGFM (Logica FM radio) and DALI, CTS instead exploit a centralized battery system, both low, LG24 (Logica 24V), and high voltage LG230 (Logic 230V) and LG EPS.



Consente l'aggregazione di più centrali di controllo, anche di sistemi differenti

Funziona come un'unica centrale di supervisione in grado di gestire un numero infinito di centrali e quindi di apparecchi, anche di illuminazione.

Allows the aggregation of several control units, even from different systems

It operates as a single supervisor control unit that can manage an infinite number of control units, including luminaires and lighting.

	TENSIONE ALIMENTAZIONE POWER SUPPLY	REST MODE	DIAGNOSI AUTONOMA SELF DIAGNOSTICS	ALIMENTAZIONE CENTRALIZZATA CENTRALIZED POWER			CLOUD NUBE PRO
TR	230Vac	✓					
AT	230Vac	✓	✓		✓		
CT	230Vac		✓		✓	✓	✓
CTS	LG230 230Vac 216Vdc		✓	✓	✓	✓	✓
	LG24 24Vdc		✓	✓	✓	✓	✓
	LG EPS 230Vac		✓	✓	✓	✓	✓
HT	230Vac 216Vdc			✓			

* Ogni impianto collegato al Cloud NuBe può gestire un numero infinito di Centrali, e quindi di apparecchi. In particolare, con le Centrali CBL, si possono realizzare con semplicità impianti di grandi dimensioni
** Integrando la **Centrale di supervisione Cod. 12131C** è possibile collegare fino a 3968 apparecchi (128 apparecchi x 31 Centrali LG Logica collegabili)

to control systems

AUTOALIMENTATI CT CT SELF-CONTAINED

Gli apparecchi CT dispongono di tecnologia Cablecom (CBL) nativa per centralizzare controllo e diagnosi dei sistemi di emergenza con trasmissione dati tramite i cavi di alimentazione elettrica. È sempre possibile inserire moduli CT opzionali per l'integrazione con altri sistemi di controllo: LG con BUS dedicato, LGFM via radio FM o DALI.

The CT luminaires feature native Cablecom (CBL) technology to centralize control and diagnosis of emergency systems with data transmission via electrical power cables. It is always possible to insert optional CT modules for integration with other control systems: LG with dedicated BUS, LGFM via FM radio or DALI.

CTS, BATTERIA CENTRALIZZATA CENTRALIZED POWER CTS

LG230, con alimentazione degli apparecchi a 230Vdc, per impianti di grandi dimensioni frazionabili con sottocentrali di controllo locale. Per impianti più ridotti LG24, con alimentazione a 24Vdc, garantisce un'estrema sicurezza grazie alla bassa tensione di esercizio di tutte le linee di alimentazione. LG EPS sono soccorritori di nuova generazione a 230 Vdc, con diagnosi autonoma

LG230, with 230Vdc power supply for large systems that can be divided in to local control sub-stations. For smaller systems, LG24, which has the characteristic of using 24Vdc for the power supply, guarantees extreme safety in all fields of application. LG EPS are 230Vdc new generation static inverters with self diagnostics.

INTERFACCIA COMUNE COMMON INTERFACE

Tutti i sistemi Beghelli utilizzano la APP B.connect per la programmazione in locale dei parametri principali.

Dalla stessa APP è possibile collegarsi al portale Cloud NuBe dove la gestione degli apparecchi, il controllo, e la programmazione dei sistemi è più evoluta e può avvenire anche in remoto. NuBe consente inoltre l'archiviazione in cloud dei dati di impianto.

All Beghelli systems use the B.connect APP for local programming of the main parameters. With the same APP it is possible to connect remotely to the NuBe Cloud where the management, the control and the programming of the systems are more advanced remotely.

NuBe also allows system data to be stored in the cloud.

CONTROLLO CENTRALIZZATO - Sistema di controllo e numero massimo di apparecchi gestiti CENTRALISED CONTROL - Control system and maximum number of luminaires managed

CT				CTS			HT
CBL	LG	LGFM	DALI	LG230	LG24	LG EPS	
nativo apparecchi CT default CT luminaires	+ Modulo / Module (cod.15036)	+ Modulo / Module (cod.15037)	+ Modulo / Module (cod.15038)				
✓ Fino a 32-Infinito* Up to 32-Infinite*	✓ Fino a 128/3968** Up to 128/3968**	✓ Fino a 256/996 Up to 256/996	✓ Fino a 64 Up to 64	✓ Fino a 3072 Up to 3072	✓ Fino a 256 Up to 256	✓ Fino a 1984 Up to 1984	✓ Fino a 64 Up to 64

* Each system connected to the NuBe Cloud can manage an infinite number of control units, and therefore of devices. In particular, with the CBL control units, large systems can be easily created

** By integrating the supervision control unit Order Code 12131C, it is possible to connect up to 3968 devices (128 devices x 31 connectable LG Logica control units)

Central Test

CT

CT-CBL, LA SEMPLICITÀ DEL CONTROLLO CENTRALIZZATO CT SENZA L'IMPLEMENTAZIONE DI BUS / CT-CBL, THE SIMPLICITY OF CENTRALIZED CT CONTROL WITHOUT THE IMPLEMENTATION OF BUS

Sistema di controllo CentralTest, progettato per offrire massima flessibilità di utilizzo ed efficienza nei sistemi di illuminazione di emergenza con apparecchi autonomi idonei sia in ambito industriale che nel terziario. L'adozione di differenti sistemi di diagnosi centralizzata (CBL, LG, LGFM, DALI) offre la giusta soluzione ad ogni problematica in ambito di sicurezza, prima fra tutte l'esecuzione dei test periodici con compilazione automatica del registro dei controlli e delle verifiche periodiche (LogBook) previsto dalla norma UNI CEI 11222.

CentralTest control system is designed to offer maximum flexibility of use and efficiency in emergency lighting systems with autonomous luminaires suitable for both industrial and tertiary sectors. The adoption of different centralized diagnosis systems (CBL, LG, LGFM, DALI) offers the right solution to every problem in the safety field most importantly the execution of periodic tests with automatic compilation of the control register and periodic checks (LogBook) required by the UNI CEI 11222 standard.

IMPIANTO CON APPARECCHI AUTOALIMENTATI CT, COMPOSTO DA DIVERSI SISTEMI DI CONTROLLO
SELF-CONTAINED SYSTEM CT, COMPOSED OF SEVERAL CONTROL SYSTEMS

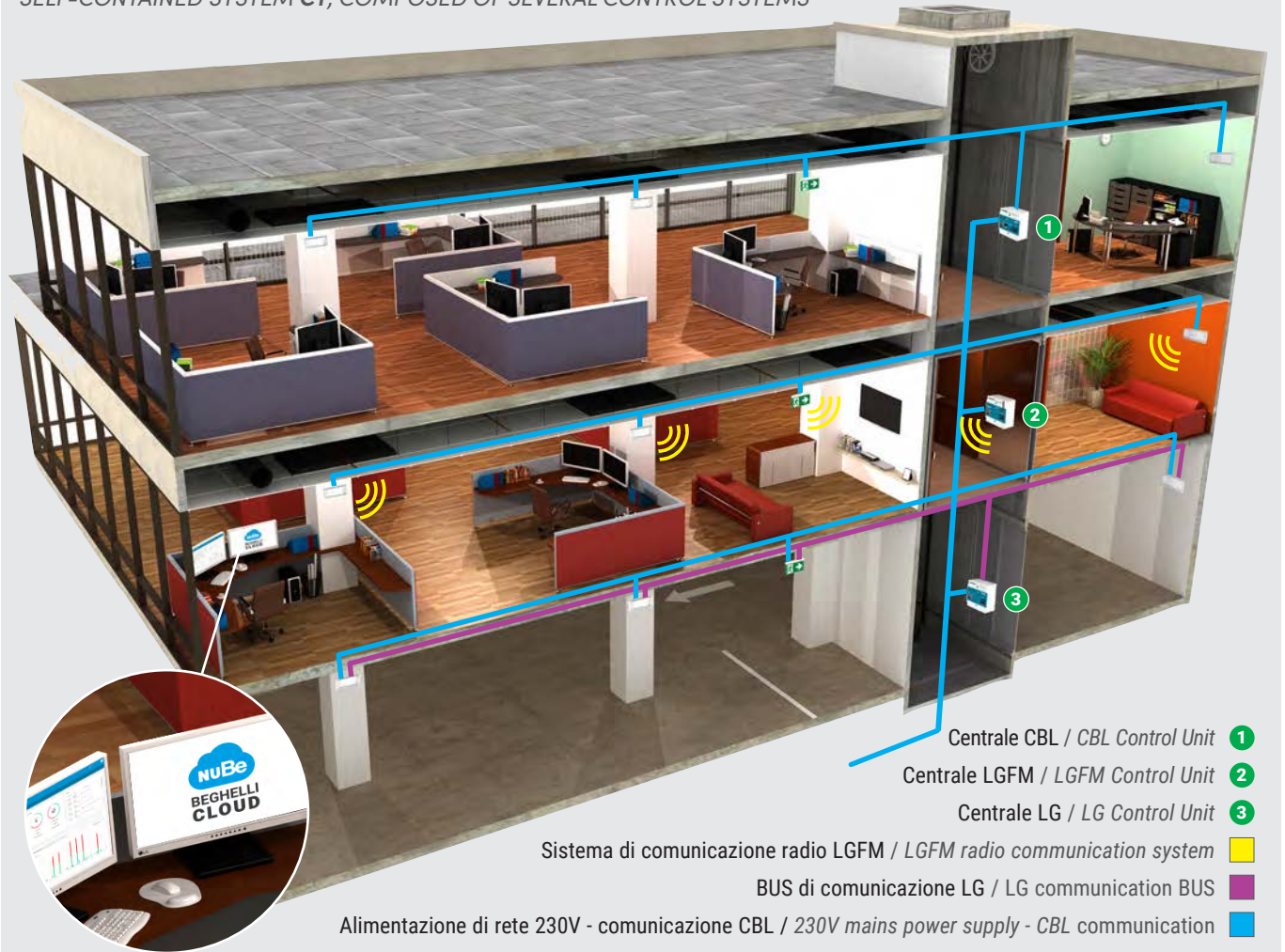

Nel caso dei sistemi LG, LGFM e DALI, gli apparecchi devono essere dotati del relativo modulo opzionale da inserire sul circuito con l'apposito connettore. Nel caso di apparecchi Modula i relativi moduli di sistema si inseriscono all'interno della staffa di derivazione, in modo rapido e immediato. Con NuBe Beghelli è inoltre possibile gestire impianti complessi e di dimensioni molto estese, aggregando in cloud un numero "infinito" di centrali e quindi di apparecchi.

In the case of LG, LGFM and DALI systems, the luminaires must be equipped with the relevant optional module to be inserted on the circuit with the appropriate connector. In the case of Modula devices, the relevant system modules are inserted into the junction bracket quickly and immediately. With NuBe Beghelli it is also possible to manage complex and very large systems, aggregating an "infinite" number of control units and therefore devices in the cloud.

Central System

CTS

**CTS: LG230, LG24, LG24 DYNAMIC, LG EPS.
LA SICUREZZA CALIBRATA PER OGNI SITUAZIONE
RIGHT SAFETY FOR EVERY SITUATION**

Tutta la gamma Central System offre la massima efficienza per i sistemi di emergenza a batteria centralizzata, grazie alla centralizzazione delle batterie in un unico luogo vicino alla centrale di controllo è possibile ottimizzare la manutenzione dell'impianto con verifiche immediate e tempestive risoluzioni di eventuali malfunzionamenti. Nella centrale vengono raggruppate tutte le funzioni di programmazione dei test periodici, il controllo e la supervisione di ogni singolo apparecchio e la stampa del LogBook impianto in conformità con la normativa UNI 11222.

The Central System range offers maximum efficiency for centralized battery emergency systems. Thanks to the centralization of the batteries in a single place, near the control unit, it is possible to optimize system maintenance with immediate checks and timely resolution of any malfunctions. All the programming functions of the periodic tests, the control and supervision of each individual luminaire and the printing of the LogBook in compliance with the UNI 11222 regulation are included in the central system.

IMPIANTO AD ALIMENTAZIONE CENTRALIZZATA CTS - LG230 CON CENTRALE E SOTTOCENTRALI
CENTRALIZED POWER SYSTEM CTS - LG230, WITH CONTROL UNIT AND SUB-UNIT



Il Sistema CTS è composto da apparecchi, centrali e sottocentrali che possono essere alimentate da batterie a 230V (LG230) o a 24V (LG24). Il sistema Beghelli, confrontandolo con altre tecnologie di riferimenti sul mercato, vanta un maggior numero di apparecchi collegabili su ogni linea. Inoltre, l'impianto realizzato con tecnologia a 230V, permette di gestire e monitorare situazioni di elevatissime dimensioni mentre la variante a 24V offre elevatissima sicurezza dell'impianto, grazie al BUS a bassa tensione.

The CTS System is made up of devices, control units and sub-control units which can be powered by 230V (LG230) or 24V (LG24) batteries. The Beghelli system, when compared with other reference technologies on the market, boasts a greater number of devices that can be connected on each line. Furthermore, the system created with 230V technology allows you to manage and monitor very large situations while the 24V variant offers very high system safety, thanks to the low voltage BUS.

Schemi unifilari / Single-line electric

emergenza / emergency

CT

CBL CABLECOM - Diagnosi centralizzata / Centralized diagnosis



B.connect



WiFi



BEGHELLI
CLOUD



Centrale / Control Unit
Cablecom Connect CBL

230V 50Hz

≤ 32 apparecchi / luminaires



ID ...



ID ...

CT

LG LOGICA - Diagnosi centralizzata / Centralized diagnosis



B.connect



WiFi



BEGHELLI
CLOUD



Centrale / Control Unit LG
+ Moduli / modules LG
a bordo lampade
on board the lamps

230V 50Hz

≤ 128 apparecchi / luminaires

BUS LOGICA

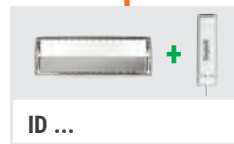

ID ...

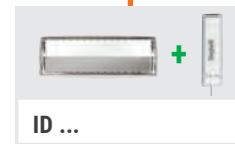

ID ...

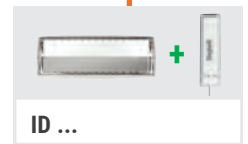

ID ...

NuBe può integrare impianti LG esistenti, sostituendo la Centrale cod.12100 con la nuova cod.12100C o la Centrale di supervisione cod.12131 con la cod.12131C
NuBe can integrate existing LG systems, replacing the control unit cod.12100 with the new code 12100C or the supervision control unit cod. 12131 with cod.12131C

CT

DALI - Diagnosi con lampade DALI / Diagnosis with DALI lamps



Controllore / Controller DALI
+
Moduli / modules DALI
a bordo lampade
on board the lamps

230V 50Hz

≤ 64 apparecchi / luminaires

BUS DALI



CT

LGFM VIA RADIO - Diagnosi centralizzata / Centralized diagnosis



B.connect



WiFi



Centrale / Control Unit
SD LGFM
+ Moduli / modules
LGFM
a bordo lampade
on board the lamps

230V 50Hz

COMUNICAZIONE RADIO
RADIO COMMUNICATION



996 apparecchi / luminaires
Centrale Logica SD LGFM

256 apparecchi / luminaires
Centrale logica compact SD LGFM

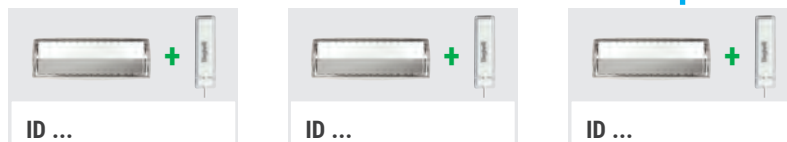

CTS

LG230 - Alimentazione e diagnosi centralizzata 230V / Centralized 230V power supply and diagnosis

F+N 230V 50Hz
o / or
3F+N 400/230V 50Hz

≤32 apparecchi / luminaires
fino / up to 345-690-1300W



300 ÷ 29.400W
1, 2, 3 h
di autonomia
autonomy

230V AC / 216VDC

FINO A 96 CIRCUITI / UP TO 96 CIRCUITS



CTS

LG24 - Alimentazione e diagnosi centralizzata 24Vdc / Centralized 24Vdc power supply and diagnosis

F+N 230V 50Hz

≤32 apparecchi / luminaires
fino / up to 72W



156 ÷ 384W
1, 2, 3 h
di autonomia
autonomy

24VDC

4 O 8 CIRCUITI / CIRCUITS





IP65

IK07

850°



CTS - HT

+40°C
-20°C



+40°C
0°C

Caratteristiche

Installazioni Parete, plafone, incasso, controsoffitto

Corpo Policarbonato, bianco RAL 9003

Ottica Simmetrica, policarbonato metallizzato antiabbagliamento

Schermo Policarbonato trasparente

Conformità EN 60598-1, EN 60598-2-2, EN 60598-2-22, UNI EN 1838, UNI 11222, EN 62034

Applicazioni

Industriale, terziario, ospedali, scuole, alberghi, ristoranti

Characteristics

Mounting Wall, ceiling, recessed, false ceiling

Housing Polycarbonate, white RAL 9003

Optics Symmetrical, anti-glare metallic polycarbonate

Screen Clear polycarbonate

Compliance EN 60598-1, EN 60598-2-2, EN 60598-2-22, UNI EN 1838, UNI 11222, EN 62034

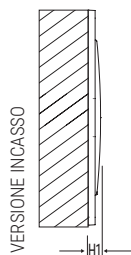

Applications

Industry, service sectors, hospitals, schools, hotels, restaurants



Versione Version	Dimensioni Dimensions mm				Distanza visibilità Distance of visibility (DV)
	L	B	H	H1	
Standard	406	147	63	-	20 m
Incasso	440	170	-	10	20 m

Prestazioni secondo EN 1838 / Performance according to EN 1838

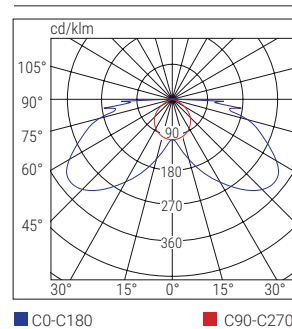

Altezza apparecchio Height 	Interasse fra gli apparecchi Centre distance VIE DI ESODO - ESCAPE ROUTES 		Area illuminata da ogni apparecchio Illuminated surface area GRANDI AREE / LARGE AREAS 	
	(m)	Parete / Wall (m)	Plafone / Ceiling (m)	Parete / Wall (m)
2.5	11	-	6x9	-
3	-	19	-	10x16
7	-	28	-	12x26
illuminamento >1lx a pavimento lungo la linea centrale senza riflessioni Emax/Emin <40 <i>lighting >1lx at floor level along the centre line without reflection Emax/Emin <40</i>			illuminamento >0,5lx a pavimento senza riflessioni Emax/Emin <40 <i>lighting >0,5lx at floor level without reflections Emax/Emin <40</i>	
Prestazioni riferite all'apparecchio Cod. 12187 110 lm <i>Performance with reference to luminaire Cod. 12187 110 lm</i>			Coefficiente di manutenzione 0,8 <i>Maintenance coefficient 0,8</i>	

LOGICA



■ C0-C180

■ C90-C270





	Cod.	W eq.	Descrizione Description	Versione Version	Autonomia Autonomy h	Flusso Flux SE lm	Flusso Flux SA lm	Assorbimento Absorbed Power		Note Notes	
								DC	AC		
CT	LG										
	12185	8	LOG LED LG 8W SA 2/4/6N 750LM	SE/SA/PS	2/4/6	750/450/350	400		8W		
	12186	11	LOG LED LG 11WSA 1.5/3/4N 900LM	SE/SA/PS	1.5/3/4	900/550/450	500		10W		
	12187	24	LOG LED LG 24WSA 1/2/3N 1100LM	SE/SA/PS	1/2/3	1100/750/550	600		14W		
	19410*	36	LOGICA LED LIFE LG SE	SE	1/1.5/3	2000/1500/800			7W		
	19411*	36	LOGICA LED LIFE LG SA	SE/SA/PS	1/1.5/3	2000/1500/800	1000		13W		
CT	LGFM										
	12185FM	8	LOG LED LGFM 8W SA 2/4/6N 750LM	SE/SA/PS	2/4/6	750/450/350	400		9W		
	12186FM	11	LOG LED LGFM 11WSA 1.5/3/4N 900LM	SE/SA/PS	1.5/3/4	900/550/450	500		11W		
	12187FM	24	LOG LED LGFM 24WSA 1/2/3N 1100LM	SE/SA/PS	1/2/3	1100/750/550	600		15W		
CTS	LG230										
	31140	8	LOGICA LED 400LM LG230	SE/SA		400	400	4.1W	8.5VA		
	31141	11	LOGICA LED 500LM LG230 LS-UV	SE/SA		500	500	6.4W	8.1VA		
	31099	24	LOGICA LED 900LM LG230 LS-UV	SE/SA		900	900	10.4W	12VA		
	31120	36	LOGICA LED 1400LM LG230 LS-UV	SE/SA		1400	1400	15W	15.9VA		
CTS	LG24										
	32096	8	LOGICA LED 400LM LG24	SE/SA		400	400	3.8W	-		
32089	36	LOGICA LED 1400LM LG24 LS-UV	SE/SA		400	1400	4.3W	15.4VA			
HT	17403	8	LOGICA LED 400LM HT	HT		400	400	4.4W	8.9VA		
	17404	11	LOGICA LED 500LM HT	HT		550	550	6.1W	6.4VA		
	17405	24	LOGICA LED 900LM HT	HT		900	900	10.2W	10.4VA		
	17406	36	LOGICA LED 1400LM HT	HT		1400	1400	14.3W	14.5VA		

* Apparecchi espandibili in versione LGFM o DALI utilizzando i relativi Moduli cod.15037 (LGFM) e Cod 15038 (DALI)









* LGFM or DALI version using expansion Modules code 15037 (LGFM) and Code 15038 (DALI)

SEGUE / NEXT >

ACCESSORI - in dotazione / ACCESSORIES - included

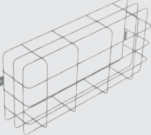
	<p>PRESSATUBO <i>CABLE CONDUIT GLAND</i></p>		<p>SCHERMO DX / RH SCREEN Solo versione SA - Serigrafia su policarbonato opale <i>SA version only - Screen print on opal polycarbonate</i></p> <p>Cod. 12175</p>	
	<p>STAFFA DI FISSAGGIO RAPIDO A PARETE IP65 <i>QUICK WALL MOUNTING BRACKET IP65</i></p> <p>Cod. 12199</p>		<p>SCHERMO SX / LH SCREEN Solo versione SA - Serigrafia su policarbonato opale <i>SA version only - Screen print on opal polycarbonate</i></p> <p>Cod. 12176</p>	
				<p>SCHERMO BASSO / DOWN SCREEN Solo versione SA - Serigrafia su policarbonato opale <i>SA version only - Screen print on opal polycarbonate</i></p> <p>Cod. 12177</p>

ACCESSORI - da ordinare separatamente / ACCESSORIES - to be ordered separately

	<p>SCATOLA INCASSO CORNICE <i>RECESSED FRAME BOX</i></p> <p>Cod. 12179</p>		<p>SCHERMO DX / RH SCREEN Serigrafia su policarbonato opale <i>Screen print on opal polycarbonate</i></p> <p>Cod. 12175</p>	
	<p>STAFFA CONTROSOFFITTO <i>FALSE CEILING BRACKET</i> 414X150 mm - foro incasso / recess hole</p> <p>Cod. 12180</p>		<p>SCHERMO SX / LH SCREEN Serigrafia su policarbonato opale <i>Screen print on opal polycarbonate</i></p> <p>Cod. 12176</p>	
	<p>GRIGLIA DI PROTEZIONE <i>PROTECTIVE GRID</i> 440x215x99 mm</p> <p>Cod. 3912</p>		<p>SCHERMO BASSO / DOWN SCREEN Serigrafia su policarbonato opale <i>Screen print on opal polycarbonate</i></p> <p>Cod. 12177</p>	
	<p>TELECOMANDO INIBIT LG <i>LG INIBIT REMOTE CONTROL</i> RM solo per versioni LG / RM for LG versions only</p> <p>Cod. 12101</p> <p style="text-align: right;">LG</p>		<p>SCHERMO ALTO / UP SCREEN Serigrafia su policarbonato opale <i>Screen print on opal polycarbonate</i></p> <p>Cod. 12178</p>	
				<p>MODULO / MODULE LGFM - DALI Solo per Cod. 19410 - 19411 <i>Only Cod. 19410 - 19411</i></p> <p>LGFM - Cod. 15037</p> <p>DALI - Cod. 15038</p> <p style="text-align: right;">LGFM DALI</p>



025 apparecchi / luminaires

Acciaio emergenza

emergenza / emergency



IP66

IK09



CTS - HT



Caratteristiche

Installazioni Parete, soffitto, sospensione, barra elettrificata

Corpo Lamiera in acciaio zincata verniciata alle polveri RAL 7035

Testate Tecnopolimero PC+PBT

Ottica Diffondente, in alluminio antiabbagliamento

Schermo Vetro temprato microprismatizzato ad alta trasmittanza (3mm)

Conformità EN 60598-1, EN 60598-2-22, EN 1838, UNI 11222, ATEX 2014/34/UE (classificazione: II 3 G Ex nA II B T135, II 3 D Ex tD A22 T85)

Applicazioni

Industriali, zone ad alto rischio anche con atmosfera esplosiva, outdoor

Characteristics

Mounting Wall, ceiling, suspended, electrified track

Housing Pre-galvanised sheet steel, powder-coated RAL 7035

Heads technopolymer PC+PBT

Optics diffusing, anti-glare aluminium

Screen High-transmission microprismatic tempered glass (3mm)

Compliance EN 60598-1, EN 60598-2-22, EN 1838, UNI 11222, ATEX 2014/34/EU (classification: II 3 G Ex nA II B T135, II 3 D Ex tD A22 T85)

Applications

Industrial, high-risk areas including explosive atmospheres, outdoors

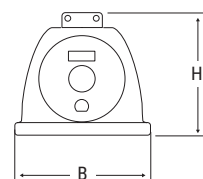
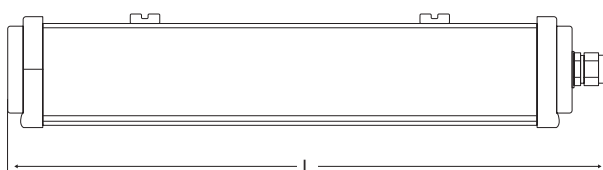

Dimensioni
Dimensions
mm

L	B	H
464	108	98.5

Prestazioni secondo EN 1838 / Performance according to EN 1838

Altezza apparecchio Height	Interasse fra gli apparecchi Centre distance VIE DI ESODO - ESCAPE ROUTES		Area illuminata da ogni apparecchio Illuminated surface area GRANDI AREE / LARGE AREAS	
	(m)	Parete / Wall (m)	Plafone / Ceiling (m)	Parete / Wall (m)
3	-	10	-	8x8
7	-	15	-	14x14

illuminamento >1lx a pavimento lungo la linea centrale senza riflessioni Emax/Emin <40 lighting >1lx at floor level along the centre line without reflection Emax/Emin <40	illuminamento >0,5lx a pavimento senza riflessioni Emax/Emin <40 lighting >0,5lx at floor level without reflections Emax/Emin <40
---	--

Prestazioni riferite all'apparecchio Cod. 15030 500 lm Performance with reference to luminaire Cod. 15030 500 lm	Coefficiente di manutenzione 0,8 Maintenance coefficient 0,8
---	---

ACCIAIO EMERGENZA

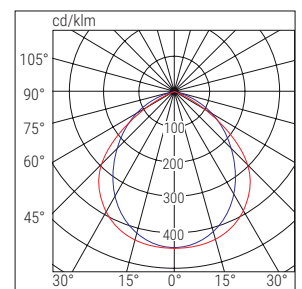

■ C90-C270 ■ C0-C180

	Cod.	W eq.	Descrizione Description	Versione Version	Autonomia Autonomy h	Flusso Flux SE lm	Flusso Flux SA lm	Assorbimento Absorbed Power		Note Notes	
								DC	AC		
CT	15032	36GL	ACC EM LED GL CT SE	SE	1/1.5/2/3/8	1800/1200/900/600/250	-		4.6 W		
	15030	24GL	ACC EM LED 24 CT SE/SA	SE/SA	1/1.5/2/3/8	500/350/250/200/70	250		4.6 W		
	LG	Moduli opzionali LG: versione 36GL integrare cod.15079 - versione 24GL integrare 15036 / Optional LG Modules: 36GL insert cod.15079 - 24GL cod. 15036									
	LGFM	Moduli opzionali LGFM: integrare cod.15037 / Optional LGFM Modules: insert cod.15037									
	DALI	Moduli opzionali DALI: versione 36GL integrare cod.15080 - versione 24GL integrare 15038 / Optional DALI Modules: 36GL insert cod.15080 - 24GL cod. 15038									
CTS	LG230										
	31054	24GL	ACCIAIO LED SA/SE LG230	SE/SA		510	510	4.7 W	9.4 VA		
	31053	36GL	ACCIAIO LED LG230 GL LS-UV	SE/SA		1800	1800	22.5 W	19.6 VA		
	LG24										
	32055	24GL	ACCIAIO LED SA/SE LG24	SE/SA		510	510	4.3 W			
	32092	36GL	ACCIAIO LED SE LG24 GL LS-UV	SE		900/1800		8/16 W			
HT	LG EPS										
	31300	36GL	ACCIAIO LED LG EPS DALI GL	SE/SA		1800	1800	-	19.6 VA		
	17452	36GL	ACCIAIO LED HT GL	HT		1800	1800	20 W	17.4 VA		

ACCESSORI - in dotazione

ACCESSORIES - included



VERSIONE CT- da ordinare separatamente

CT VERSION - to be ordered separately

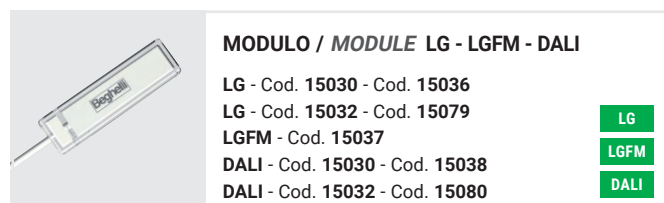

ACCESSORI - da ordinare separatamente / ACCESSORIES - to be ordered separately

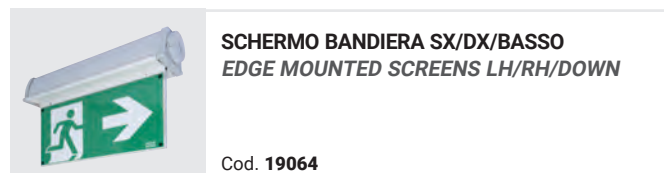

Pratica Modula Matrix

emergenza / emergency



WEB CATALOGUE



CTS - HT

IP65

IK07

850°



+40°C
-20°C



+40°C
0°C

Caratteristiche

Installazioni Parete, soffitto, incasso, **controsoffitto**, inclinata 45°, binario trifase, blindoluce, sospensione

Corpo Policarbonato, bianco RAL 9003

Ottica Policarbonato - tipo Matrix

Conformità EN 60598-1, EN 60598-2-2, EN 60598-2-22, UNI EN 1838, UNI 11222, EN 62034

Applicazioni

Industriale, terziario, civile, Ospedali, Hotel, uffici, scuole

Characteristics

Mounting Wall, ceiling, recessed, false ceiling, tilted 45°, three-phase track, lighting busbars, suspended

Housing Polycarbonate, white RAL 9003

Optics Polycarbonate - Matrix type

Compliance EN 60598-1, EN 60598-2-2, EN 60598-2-22, UNI EN 1838, UNI 11222, EN 62034

Applications

Industrial, service sectors, residential, hospitals, hotels, offices, schools

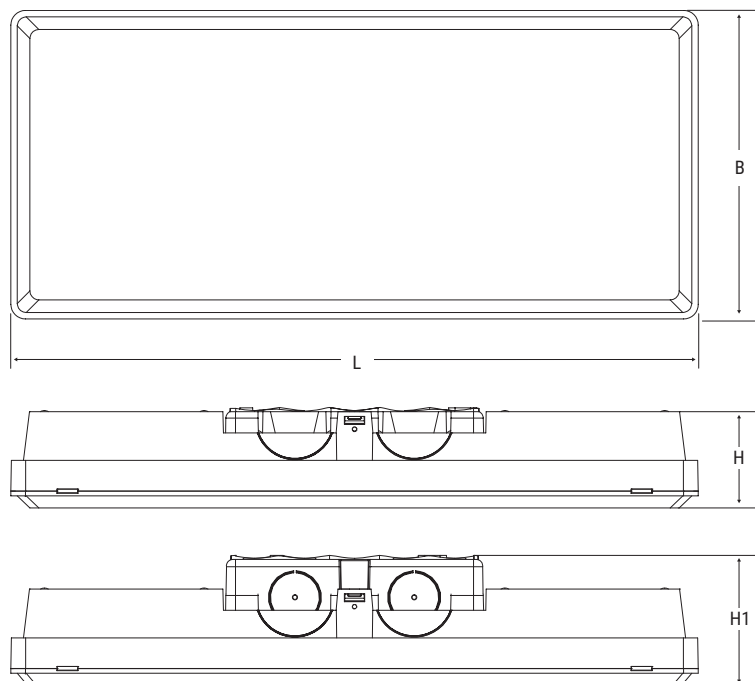

Dimensioni
Dimensions
mm

L	B	H	H1
265	119	39	50

Prestazioni secondo EN 1838 / Performance according to EN 1838

Ottica Matrix	Altezza apparecchio Height	Interasse fra gli apparecchi Centre distance VIE DI ESODO - ESCAPE ROUTES		Area illuminata da ogni apparecchio Illuminated surface area GRANDI AREE / LARGE AREAS	
	(m)	Parete / Wall (m)	Plafone / Ceiling (m)	Parete / Wall (m)	Plafone / Ceiling (m)
GRANDI AREE LARGE AREAS Largaluce	2,5	-	-	10x16 (160mq)	-
	3	-	-	-	14x19 (260mq)
	7	-	-	-	23x26 (600mq)
VIE DI ESODO ESCAPE ROUTES Lungaluce	2,5	19	-	-	-
	3	-	23	-	-
	7	-	33	-	-
ALTO RISCHIO HIGH RISK Altorischio	7				10 mq (60lx)
	12				10 mq (30lx)

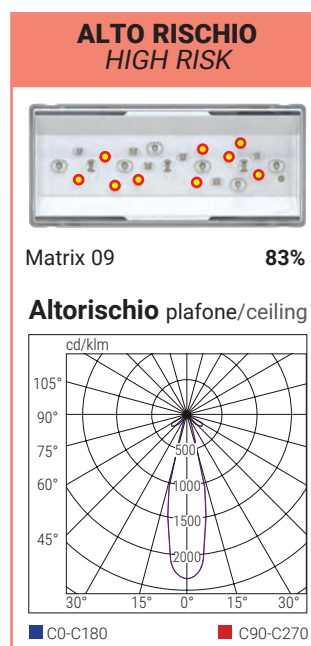

Prestazioni riferite all'apparecchio Cod. 18841 1h / Performance with reference to luminaire Cod. 18841 1h

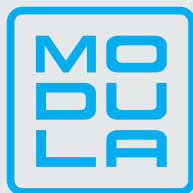
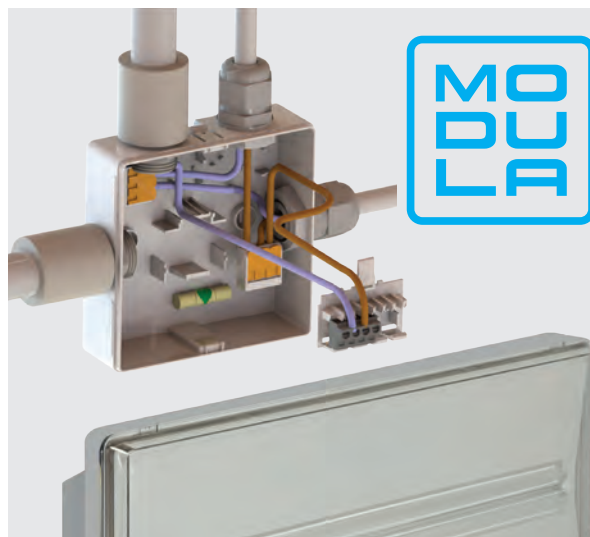
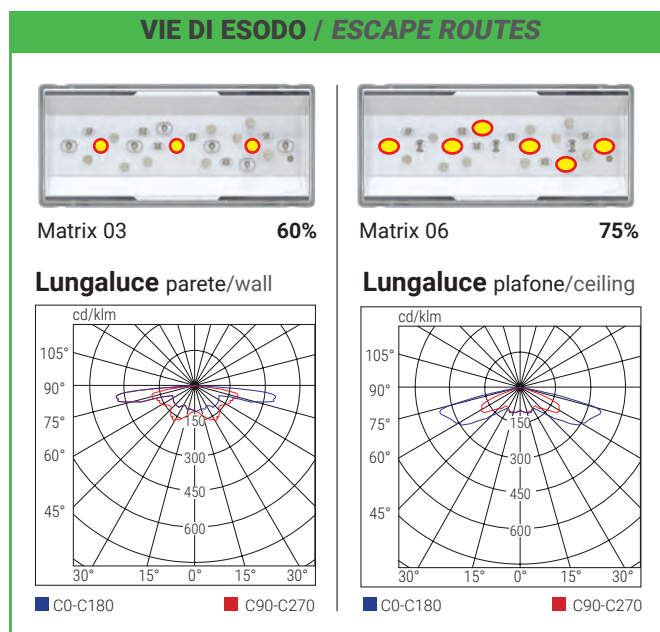
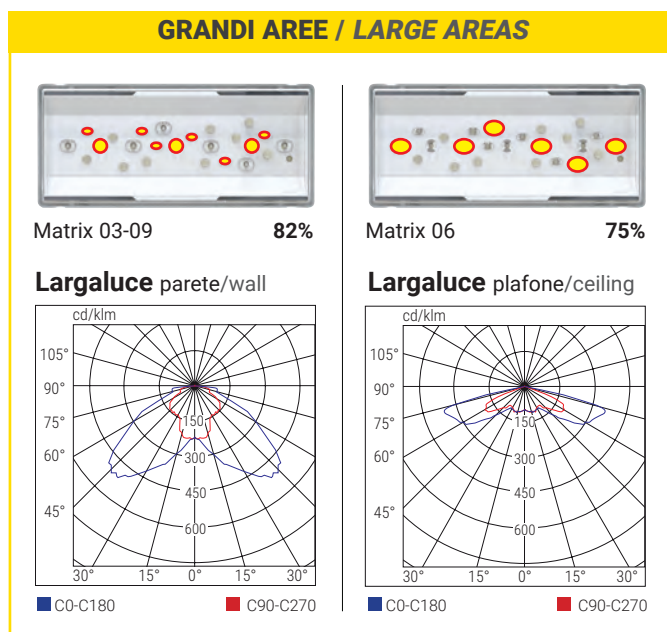

STAFFADI DERIVAZIONE EASY BOX INTEGRATA INTEGRATED EASY BOX JUNCTION BRACKET

TEMPI DI INSTALLAZIONE RIDOTTI FINO AD OLTRE IL 50%

Il sistema Modula raggruppa le fasi di cablaggio e programmazione all'interno della staffa, prima di montare l'apparecchio.

INSTALLATION TIMES REDUCED UP TO MORE THAN 50%

Modula system group together all the wiring and programming phases before mounting the luminaire.



SEGUE / NEXT >

Pratica Modula Matrix

emergenza / emergency







	Cod.	W eq.	Descrizione Description	Versione Version	Autonomia Autonomy h	Flusso Flux SE Im	Flusso Flux SA Im	Assorb. max. Absorbed Power		Note Notes	
								DC	AC		
CT	18821	36WGL	MATRIX 1000 IP65 CT SA/SE	SE/SA/PS	1/1.5/2/3/8	1000/700/550/350/125	250		9W		
	18831	36WGL	MATRIX 2000 IP65 CT SA/SE	SE/SA/PS	1/1.5/2/3/8	2000/1400/1000/700/250	250		9W		
	18841	36WGL	MATRIX 2700 IP65 CT SA/SE	SE/SA/PS	1/1.5/2/3/8	2700/2000/1500/1000/400	250		9W		
	LG	Apparecchi con diagnosi centralizzata LG integrando il Modulo Cod.15056 / <i>Luminaires with LG centralized control integrating Module Cod.15056</i>									
	LGFM	Apparecchi con diagnosi centralizzata LGFM integrando il Modulo Cod.15057 / <i>Luminaires with LGFM centralized control integrating Module Cod.15057</i>									
	DALI	Apparecchi con diagnosi centralizzata DALI integrando il Modulo Cod. 15058 / <i>Luminaires with DALI centralized control integrating Module Cod. 15058</i>									
CTS	17923	36GL	MATRIX 1500 REG IP65 HT/CTS	HT-CTS			1500/750	7.1W 3.5W	14VA 7VA		
	LG230	Apparecchi con diagnosi centralizzata LG230 integrando il Modulo Cod. 15060 / <i>Luminaires with LG230 centralized control integrating Module Cod. 15060</i>									
	LG24	Apparecchi con diagnosi centralizzata LG24 integrando il Modulo Cod.15059 / <i>Luminaires with LG24 centralized control integrating Module Cod.15059</i>									
	LG EPS	Apparecchi con diagnosi centralizzata LG EPS integrando il Modulo Cod.15061 / <i>Luminaires with LG EPS centralized control integrating Module Cod.15061</i>									

* I flussi indicati sono espressi senza schermo lenticolare. Per individuare il flusso di prodotto, oltre al valore in tabella, dovrà essere considerato il rendimento percentuale indicato nella fotometria della lente e alla configurazione Matrix più performante / *The fluxes are expressed without lenticular screen. To identify the product flux, in addition to the value in the table, the percentage yield indicated in the photometry of the lens must be considered and the Matrix most performing configuration*

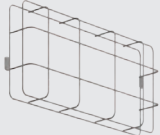
ACCESSORI - in dotazione / ACCESSORIES - included

	STAFFA DI DERIVAZIONE EASY BOX <i>EASY BOX JUNCTION BRACKET</i>	Cod. 18589		CORNICE ESTETICA <i>AESTHETIC FRAME</i>	Cod. 18598
---	---	-------------------	--	---	-------------------

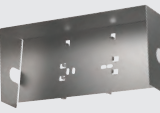
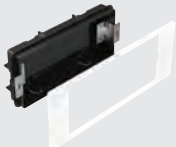
ACCESSORI - da ordinare separatamente / ACCESSORIES - to be ordered separately

	GRIGLIA EM <i>EM PROTECTIVE GRID</i> 305x130x100mm	Cod. 18591		PRESSA TUBO + KIT IP65 <i>Tubo Box basso / Low Conduit Box</i>	Cod. 18592
	STAFFA 45° <i>45° BRACKET</i>	Cod. 18590		GANCI PER SOSPENSIONE <i>SUSPENDED MOUNTING HOOKS</i>	Cod. 3723
	KIT BINARIO TRIFASE <i>THREE-PHASE TRACK KIT</i>	Cod. 4319		TEGOLINO PIOGGIA INOX <i>RAIN COVER IN STAINLESS STEEL</i>	Cod. 18597
	SCATOLA INCASSO + CORNICE <i>RECESSED FRAME + BOX</i> Verniciabile / <i>Paintable</i>	Cod. 18580		STAFFA CONTROSOFFITTO CARTONGESSO + CORNICE / PLASTERBOARD FALSE CEILING BRACKET + FRAME Verniciabile / <i>Paintable</i>	Cod. 18586

ACCESSORI - da ordinare separatamente / **ACCESSORIES** - to be ordered separately



STAFFA BLINDOLUCE
LIGHTING BUSBAR BRACKET
Verniciabile / Paintable

Cod. **18587**



ADATTATORE PER SCATOLA INCASSO
RECESSED BOX ADAPTER

Cod. **18599**



MODULO/ MODULE LG - LGFM - DALI
Solo versione CT / Only version CT

LG - Cod. **15056**
LGFM - Cod. **15057**
DALI - Cod. **15058**



BOX DI CONVERSIONE SISTEMA
CONVERSION SYSTEM BOX

Solo versione HT-CTS

LG24 - Cod. **15059** **LG EPS** - Cod. **15061**
LG230 - Cod. **15060**



Pratica Modula

emergenza / emergency



WEB CATALOGUE



BOOSTER BATTERY Fino al **50%** in più di **flusso luminoso**



IP65

IP42

IK07

850°



RM



CTS - HT
+40°C
-20°C

ICE PACK
+40°C
-30°C

+40°C
0°C

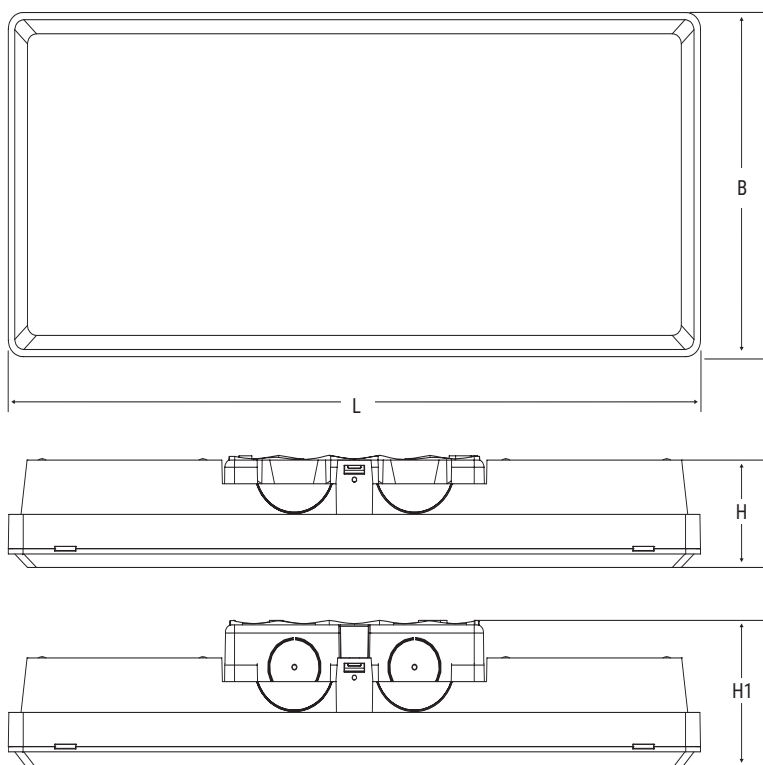

Caratteristiche

Installazioni Parete, soffitto, incasso, controsoffitto, bandiera, inclinata 45°, binario trifase, blindoluce, sospensione

Corpo Polycarbonato, bianco RAL 9003

Ottica PMMA a riflessione totale interna

Schermo Polycarbonato trasparente

Conformità EN 60598-1, EN 60598-2-22, EN 60598-2-2, EN 62034, UNI EN 1838, UNI 11222, EN 60598-2-22

Applicazioni

Industriale, terziario, civile, ospedali, Hotel, scuole, uffici

Characteristics

Mounting Wall, ceiling, recessed, false ceiling, edge, tilted 45°, three-phase track, lighting busbars, suspended

Housing Polycarbonate, white RAL 9003

Optics PMMA Total Internal Reflection

Screen Clear polycarbonate

Compliance EN 60598-1, EN 60598-2-22, EN 60598-2-2, EN 62034, UNI EN 1838, UNI 11222, EN 60598-2-22

Applications

Industrial, service sectors, residential, hospitals, hotels, schools, offices

Dimensioni Dimensions mm				Distanza visibilità Distance of visibility (DV)
L	B	H	H1	
265	119	39	50	25 m

Prestazioni secondo EN 1838 / Performance according to EN 1838

Altezza apparecchio Height	Interasse fra gli apparecchi Centre distance VIE DI ESODO - ESCAPE ROUTES		Area illuminata da ogni apparecchio Illuminated surface area GRANDI AREE / LARGE AREAS	
	(m)	Parete / Wall (m)	Parete / Wall (m)	Plafone / Ceiling (m)
2.5	11	-	8x12	-
3	-	18	-	10x16
7	-	25	-	14x20

illuminamento >1lx a pavimento lungo la linea centrale senza riflessioni Emax/Emin <40 lighting >1lx at floor level along the centre line without reflection Emax/Emin <40	illuminamento >0,5lx a pavimento senza riflessioni Emax/Emin <40 lighting >0,5lx at floor level without reflections Emax/Emin <40
---	--

PRATICA MODULA

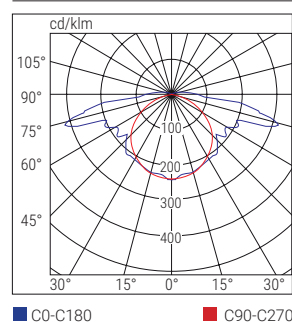

■ C0-C180 ■ C90-C270

Prestazioni riferite all'apparecchio Cod. Ord. 18731 1000 lm
Performance with reference to luminaire Cod. Ord. 18731 1000 lm

Coefficiente di manutenzione 0,8
Maintenance coefficient 0,8

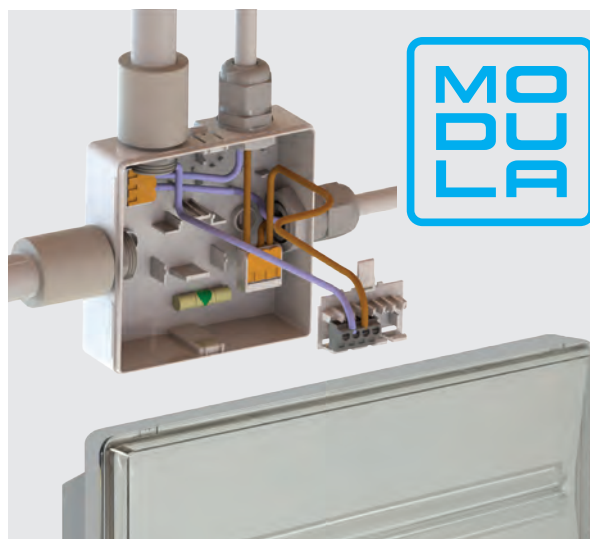

STAFFADI DERIVAZIONE EASY BOX INTEGRATA INTEGRATED EASY BOX JUNCTION BRACKET

TEMPI DI INSTALLAZIONE RIDOTTI FINO AD OLTRE IL 50%

Il sistema Modula raggruppa le fasi di cablaggio e programmazione all'interno della staffa, prima di montare l'apparecchio.

INSTALLATION TIMES REDUCED UP TO MORE THAN 50%

Modula system group together all the wiring and programming phases before mounting the luminaire.



Cod.	W eq.	Descrizione Description	Versione Version	Autonomia Autonomy h	Flusso Flux SE lm	BOOSTER BATTERY Flusso / Flux SE lm >50%	Flusso Flux SA lm	Assorbimento Absorbed Power		Note Notes
								DC	AC	
18600	24	P.MODULA 150 IP42 SE RM	SE	1/1.5/2/3	150/100/85/55	RA10 BATTERY	-	3.5W	IP42	
18601	24	P.MODULA 150 IP42 SE/SA RM	SE/SA	1/1.5/2/3	150/100/85/55	RA10 BATTERY	250	5.8W	IP42	
18610	24GL	P.MODULA 300 IP42 SE RM	SE	1/1.5/2/3	300/200/165/110	RA11 BATTERY	-	3.5W	IP42	
18611	24GL	P.MODULA 300 IP42 SE/SA RM	SE/SA	1/1.5/2/3	300/200/165/110	RA11 BATTERY	250	5.8W	IP42	
18620	36	P.MODULA 500 IP42 SE RM	SE	1/1.5/2/3	500/350/275/175	RA11 BATTERY	-	3.5W	IP42	
18621	36	P.MODULA 500 IP42 SE/SA RM	SE/SA	1/1.5/2/3	500/350/275/175	RA11 BATTERY	250	5.8W	IP42	
18630	24	P.MODULA 150 IP65 SE RM	SE	1/1.5/2/3	150/100/85/55	RA10 BATTERY	-	3.5W		
18631	24	P.MODULA 150 IP65 SE/SA RM	SE/SA	1/1.5/2/3	150/100/85/55	RA10 BATTERY	250	5.8W		
18640	24GL	P.MODULA 300 IP65 SE RM	SE	1/1.5/2/3	300/200/165/110	RA11 BATTERY	-	3.5W		
18641	24GL	P.MODULA 300 IP65 SE/SA RM	SE/SA	1/1.5/2/3	300/200/165/110	RA11 BATTERY	250	5.8W		
18650	36	P.MODULA 500 IP65 SE RM	SE	1/1.5/2/3	500/350/275/175	RA11 BATTERY	-	3.5W		
18651	36	P.MODULA 500 IP65 SE/SA RM	SE/SA	1/1.5/2/3	500/350/275/175	RA11 BATTERY	250	5.8W		
18660	36GL	P.MODULA 700 IP65 SE RM	SE	1/1.5/2/3	700/500/400/250	RA11 BATTERY	-	3.5W		
18661	36GL	P.MODULA 700 IP65 SE/SA RM	SE/SA	1/1.5/2/3	700/500/400/250	RA11 BATTERY	250	5.8W		
18670	36GL	P.MODULA 1000 IP65 SE RM	SE	1/1.5/2/3	1000/700/550/350	RA11 BATTERY	-	3.5W		
18671	36GL	P.MODULA 1000 IP65 SE/SA RM	SE/SA	1/1.5/2/3	1000/700/550/350	RA11 BATTERY	250	5.8W		

SEGUE / NEXT >

TR

033 apparecchi / luminaires

Pratica Modula

emergenza / emergency

	Cod.	W eq.	Descrizione Description	Versione Version	Autonomia Autonomy h	Flusso Flux SE Im	BOOSTER BATTERY Flusso / Flux SE Im >50%	Flusso Flux SA Im	Assorbimento max.		Note
									DC	AC	
AT	18700	24GL	P.MODULA 300 IP65 AT SE RM	SE	1/1.5/2/3/8	300/200/165/110/40		-		4W	
	18701	24GL	P.MODULA 300 IP65 AT SE/SA RM	SE/SA/PS	1/1.5/2/3/8	300/200/165/110/40		250		6W	
	18710	36	P.MODULA 500 IP65 AT SE RM	SE	1/1.5/2/3/8	500/350/275/165/65		-		4W	
	18711	36	P.MODULA 700 IP65 AT SE/SA RM	SE/SA/PS	1/1.5/2/3/8	500/350/275/165/65		250		6W	
	18721	36GL	PM 700 IP65 AT SE/SA RM	SE/SA/PS	1/1.5/2/3/8	700/500/400/250/90		250		6W	
	18731	36GL	P.MODULA 1000 IP65 AT SE/SA RM	SE/SA/PS	1/1.5/2/3/8	1000/700/550/350/125		250		6W	
CT	18740	24GL	P.MODULA 300 IP65 CT SE	SE	1/1.5/2/3/8	300/200/165/110/40		-		4.5W	
	18741	24GL	P.MODULA 300 IP65 CT SE/SA	SE/SA/PS	1/1.5/2/3/8	300/200/165/110/40		250		6W	
	18750	36GL	P.MODULA 500 IP65 CT SE	SE	1/1.5/2/3/8	500/350/275/165/65		-		4.5W	
	18751	36GL	P.MODULA 500 IP65 CT SE/SA	SE/SA/PS	1/1.5/2/3/8	500/350/275/165/65		250		6W	
	18761	36GL	P.MODULA 700 IP65 CT SE/SA	SE/SA/PS	1/1.5/2/3/8	700/500/400/250/90		250		6W	
	18771	36GL	P.MODULA 1000 IP65 CT SE/SA	SE/SA/PS	1/1.5/2/3/8	1000/700/550/350/125		250		6W	
	18781	36GL	P.MODULA 2000 IP65 CT SE/SA	SE/SA/PS	1/1.5/2/3/8	1700/1500/1000/750/300		250		7.8W	
CTS	17920	36GL	P.MODULA 1500 REG IP65 HT/CTS	HT-CTS				1500/1125/750/375	11.5W 8.6W 5.75W 2.87W	20VA 15VA 10VA 5VA	
	LG230	Apparecchi con diagnosi centralizzata LG230 integrando il Modulo Cod. 15060 / Luminaires with LG230 centralized control integrating Module Cod. 15060									
	LG24	Apparecchi con diagnosi centralizzata LG24 integrando il Modulo Cod.15059 / Luminaires with LG24 centralized control integrating Module Cod.15059									
	LG EPS	Apparecchi con diagnosi centralizzata LG EPS integrando il Modulo Cod.15061 / Luminaires with LG EPS centralized control integrating Module Cod.15061									

ACCESSORI - in dotazione / ACCESSORIES - included



**STAFFA DI DERIVAZIONE EASY BOX
EASY BOX JUNCTION BRACKET**

Cod. **18589**



**ADESIVI SX/DX/BASSO/ALTO
LH/RH/UP/DOWN STICKERS**
In dotazione solo nelle versioni SA
Included only in the SA versions

Cod. **18584**



**CORNICE ESTETICA
AESTHETIC FRAME**

Cod. **18598**

ACCESSORI - da ordinare separatamente / **ACCESSORIES** - to be ordered separately



GRIGLIA EM
EM PROTECTIVE GRID
305x130x100mm

Cod. **18591**



PRESSATUBO + KIT IP65
CABLE GLAND + KIT IP65 ACCESSORY KIT
Tubo Box basso / Low Conduit Box

Cod. **18592**



STAFFA 45°
45° BRACKET

Cod. **18590**



GANCI PER SOSPENSIONE
SUSPENDED MOUNTING HOOKS

Cod. **3723**



KIT BINARIO TRIFASE
THREE-PHASE TRACK KIT

Cod. **4319**



TEGOLINO PIOGGIA INOX
RAIN COVER IN STAINLESS STEEL

Cod. **18597**



SCATOLA INCASSO + CORNICE
RECESSED FRAME + BOX
Verniciabile / Paintable

Cod. **18580**



STAFFA CONTROSFITTO CARTONGESSO
+ CORNICE / PLASTERBOARD FALSE
CEILING BRACKET + FRAME
Verniciabile / Paintable

Cod. **18586**



STAFFA BLINDOLUCE
LIGHTING BUSBAR BRACKET
Verniciabile / Paintable

Cod. **18587**



ADATTATORE PER SCATOLA INCASSO
RECESSED BOX ADAPTER

Cod. **18599**



MODULO/ MODULE LG - LGFM - DALI
Solo versione CT / Only version CT

LG - Cod. **15056**
LGFM - Cod. **15057**
DALI - Cod. **15058**



BOOSTER BATTERY
Fino al 50% di flusso luminoso in più
Only version CT

S (LiFe 3.2V 0,5Ah) - Cod. **RA10**
M (LiFe 3.2V 1,5Ah) - Cod. **RA11**



STAFFA FISSAGGIO BANDIERA
EDGE MOUNTING FIXING BRACKET

Cod. **18585**



BOX DI CONVERSIONE SISTEMA
CONVERSION SYSTEM BOX
Solo versione HT-CTS / Only HT- CTS version

LG24 - Cod. **15059** **LG EPS** - Cod. **15061**
LG230 - Cod. **15060**



SCHERMI / SCREENS

SX / LH - Cod. **18593** **BASSO / LOW** - Cod. **18595**
DX / RH - Cod. **18594** **ALTO / HIGH** - Cod. **18596**



ICE PACK MODULA
Sistema di riscaldamento automatico delle batterie in grado di mantenerle ad una temperatura superiore a 15°C garantendo la ricarica corretta in sicurezza. Idoneo solo per versioni fino a 500lm.



SCHERMI BANDIERA
EDGE MOUNTED SCREENS

SX-DX / LH-RH - Cod. **4127**
BASSO / LOW - Cod. **4128**
ALTO / HIGH - Cod. **4129**

MODULA ICE PACK
Automatic battery heating system to maintain the temperature above 15°C ensuring correct and safe charging. Only suitable for versions up to 500lm.

ICE PACK
+40°C
-30°C

Cod. **15078**



SCHERMI BANDIERA AD ELEVATA LUMINOSITÀ
HIGH LUMINOUS EDGE MOUNTED SCREENS

SX-DX / LH-RH - Cod. **18581**
BASSO / LOW - Cod. **18582**
ALTO / HIGH - Cod. **18583**



TELECOMANDO INIBIT RM
RM INIBIT REMOTE CONTROL
Solo apparecchi TR e AT equipaggiati di modulo RM
Only TR and AT devices equipped with RM module

Cod. **2730**

RM

Infinita RTI

emergenza / emergency



WEB
CATALOGUE



IP65

IK08



CTS - HT

+40°C
-20°C



+40°C
0°C

Caratteristiche

Installazioni parete, soffitto, incasso, controsoffitto, bandiera a parete/soffitto, sospensione, sospensione con Tiges

Corpo Policarbonato bianco RAL 9003

Ottica Lente in PMMA a tecnologia RTI (Riflessione Totale Interna)

Schermo Policarbonato trasparente

Conformità EN 60598-1, EN 60598-2-2, EN 60598-2-22, UNI EN 1838, UNI 11222, EN 62034

Applicazioni

Industriale, terziario, civile, ospedali, Hotel, scuole, uffici

Characteristics

Mounting Wall, ceiling, recessed, false ceiling, wall/ceiling edge mounting, suspended, suspended on rods

Housing Polycarbonate, white RAL 9003

Optics PMMA, Total Internal Reflection

Screen Clear polycarbonate

Compliance EN 60598-1, EN 60598-2-2, EN 60598-2-22, UNI EN 1838, UNI 11222, EN 62034

Applications

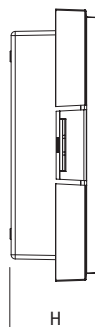
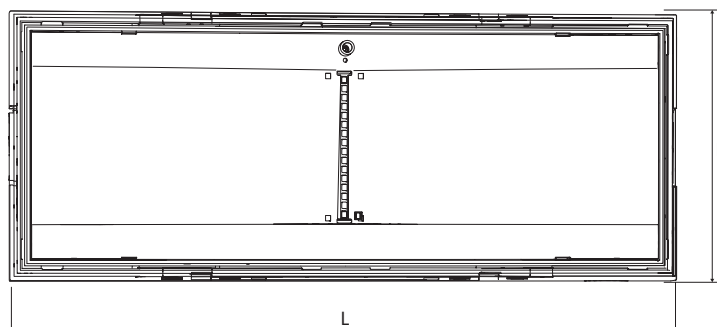

Industrial, service sectors, residential, hospitals, hotels, schools, offices



Dimensioni Dimensions mm			Distanza visibilità Distance of visibility (DV)
L	B	H	
325	130	45	25 m

Prestazioni secondo EN 1838 / Performance according to EN 1838

INFINITA

Altezza apparecchio Height 	Interasse fra gli apparecchi Centre distance VIE DI ESODO - ESCAPE ROUTES 		Area illuminata da ogni apparecchio Illuminated surface area GRANDI AREE / LARGE AREAS 	
	(m)	Parete / Wall (m)	Plafone / Ceiling (m)	Parete / Wall (m)
2.5	14	-	8x9	-
3	-	20	-	10x16
7	-	20	-	15x15
illuminamento >1lx a pavimento lungo la linea centrale senza riflessioni Emax/Emin <40 lighting >1lx at floor level along the centre line without reflection Emax/Emin <40			illuminamento >0,5lx a pavimento senza riflessioni Emax/Emin <40 lighting >0,5lx at floor level without reflections Emax/Emin <40	

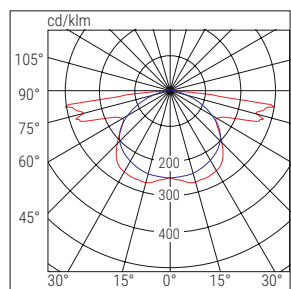









■ C90-C270

■ C0-C180

Prestazioni riferite all'apparecchio Cod. 19460 1000 lm
Performance with reference to luminaire Cod. 19460 1000 lm

Coefficiente di manutenzione 0,8
Maintenance coefficient 0,8



	Cod.	W eq.	Descrizione Description	Versione Version	Autonomia Autonomy h	Flusso Flux SE lm	Flusso Flux SA lm	Assorbimento Absorbed Power		Note Notes
								DC	AC	
CT	19450	24	INFINITA RTI CT SE L	SE	1/1.5/2/3/8	250/170/130/90/40			1.9 VA	
	19451	24GL	INFINITA RTI CT SE XL	SE	1/1.5/2/3/8	500/340/260/180/70			1.9 VA	
	19452	24	INFINITA RTI CT SA L	SE/SA	1/1.5/2/3/8	250/170/130/90/40	250		3.9 VA	
	19453	24GL	INFINITA RTI CT SA XL	SE/SA	1/1.5/2/3/8	500/340/260/180/70	250		3.9 VA	
	19454	36GL	INF RTI CT SE XL 700LM	SE	1/1.5/2/3/8	700/500/400/250/100			1.9 VA	
	19455	36GL	INF RTI CT SA XL 700LM	SE/SA	1/1.5/2/3/8	700/500/400/250/100	250		3.9 VA	
	19460	36GL	INFINITA GL RTI CT SA	SE/SA	1/1.5/2/3/8	1400/950/730/520/200	250		3.9 VA	
	19470	36GL	INFINITA RTI GL CT SA	SE/SA	1/1.5/2/3/8	1700/1200/900/600/250	850		6.6 VA	





Gli apparecchi CT possono integrare dispositivi opzionali per l'espansione ad altri sistemi: Modulo LG cod.15036 - Modulo LGFM Cod.15037 - Modulo DALI cod.15038
The CT luminaires can integrate optional devices for expansion to other systems: LG module code 15036 - LGFM module code 15037 - DALI module code 15038

CTS	LG230										
	31170	24GL	INFINITA RTI LG230 SE/SA L	SE/SA		500	500	4.5 W	8.6 VA		
	31171	36GL	INFINITA RTI LG230 SE/SA XL	SE/SA		1500	1500	15.1 W	16.3 VA		
	LG24										
CTS	32110	24GL	INFINITA RTI LG24 SE/SA L	SE		500	500	3.9 W	0.0 VA		
	32111	36GL	INFINITA RTI LG24 SE/SA XL	SE/SA		500	1500	4.3 W	16.1 VA		
HT	LGEPS										
	31301	8	INFINITA RTI LG EPS DALI L	SE/SA		500	500		8.6 VA		
HT	31174	24GL	INFINITA RTI HT L	HT		500	500	4.5 W	9.0 VA		
	31175	36GL	INFINITA RTI HT XL	HT		1500	1500	15.1 W	16.1 VA		







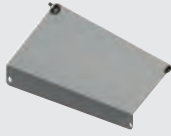

SEGUE / NEXT >

Infinita RTI

ACCESSORI - in dotazione / ACCESSORIES - included

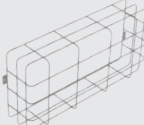
	<p>PRESSACAVO M20 VENTILATO CABLE GLAND M20 WITH VENT</p>		<p>CABLAGGIO PASSANTE 5-POLE FEED-THROUGH WIRING Solo versioni HT230 <i>HT230 versions only</i></p>
	<p>MEMBRANA PRESSACAVO M16 IP65 CABLE GLAND MEMBRANE M16 IP65</p>		<p>ADESIVI SX/DX/BASSO/ALTO LH/RH/DOWN/UP STICKERS In dotazione solo nelle versioni SA <i>Included for SA versions only</i> Cod. 4682</p>
	<p>ADATTATORE TUBO 16/20mm BIANCO CONDUIT ADAPTER 16/20 mm WHITE Installazione con tubo Ø 16 o Ø 20 mm <i>Mounting with a Ø16 or Ø20 mm conduit</i></p>		

ACCESSORI - da ordinare separatamente / ACCESSORIES - to be ordered separately

	<p>SCHERMO BANDIERA 25M EDGE MOUNTING SCREEN 25M</p> <p>Cod. 4681</p>		<p>STAFFA 45° 45° BRACKET</p> <p>Cod. 18590</p>
	<p>SCATOLA INCASSO LED RECESSED LED BOX</p> <p>Cod. 4683</p>		<p>SOSPENSIONE TIGES SUSPENDED MOUNTING RODS 250 - 500 - 1000 mm Cod. 4315 (250mm) - 4316 (500mm) 4317 (1000mm)</p>
	<p>STAFFA INCASSO CARTONGESSO PLASTERBOARD RECESSED MOUNTING BRACKET</p> <p>Cod. 4687</p>		<p>GRIGLIA DI PROTEZIONE PROTECTIVE GRID 440 x 215 x 99 mm Cod. 3912</p>
	<p>STAFFA FISSAGGIO BANDIERA EDGE MOUNTING FIXING BRACKET</p> <p>Cod. 18585</p>		<p>GANCI PER SOSPENSIONE SUSPENDED MOUNTING HOOKS</p> <p>Cod. 3723</p>
	<p>CABLAGGIO PASSANTE THROUGH WIRING</p> <p>Cod. 20155</p>		<p>MODULO / MODULE LG - LGFM - DALI Solo per apparecchi CT / <i>CT version only</i></p> <p>LG - Cod. 15036 LGFM - Cod. 15037 DALI - Cod. 15038</p>

LG
LGFM
DALI

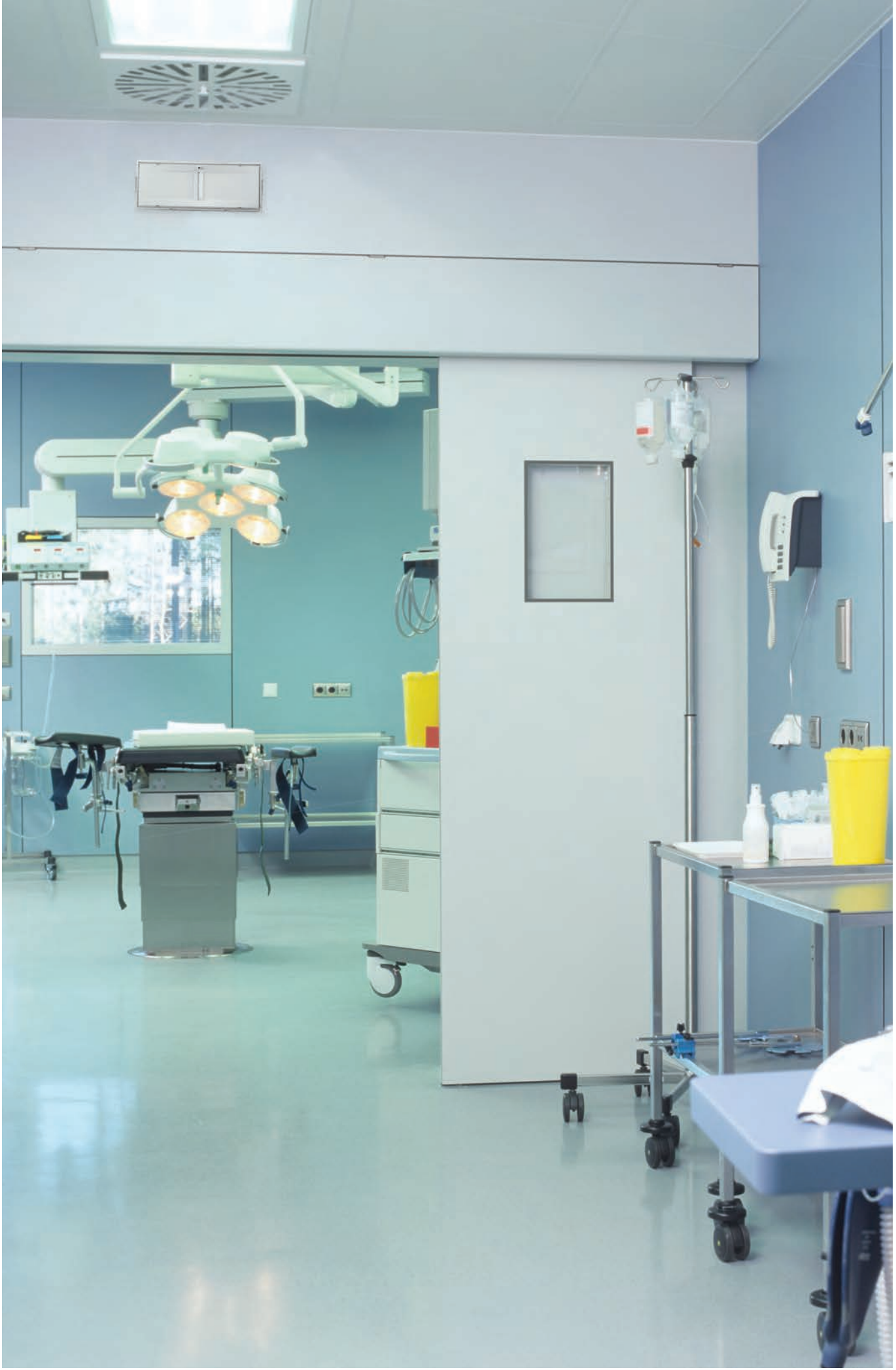

039 apparecchi / luminaires

Infinita SanificaAria

emergenza / emergency



Caratteristiche Emergenza

Installazioni parete, soffitto, bandiera a parete/soffitto, sospensione

Corpo ABS bianco RAL 9003

Ottica Riflessione Totale Interna

Schermo Policarbonato trasparente

Conformità EN60598-1, EN60598-2-2, EN60598-2-22, EN60335-2-65, ISO 15714, 2014/53/UE

Applicazioni

Industriale, terziario, ospedali, attività commerciali, negozi, ristoranti, uffici, scuole

Emergency features

Mounting Wall, ceiling, wall/ceiling edge mounting, suspended

Housing ABS white RAL 9003

Optics Total Internal Reflection

Screen Clear polycarbonate

Compliance EN60598-1, EN60598-2-2, EN60598-2-22, EN60335-2-65, ISO 15714, 2014/53/EU

Caratteristiche Sanificatore Specifications of the Air Purifier

UV-C wavelength 254nm

Sanitisation flow rate 8 m³/h

UV-C power 7W

UV-C radiation power 2.4W

Applications

Industry, service sector, hospitals, commercial activities, shops, restaurants, offices, schools

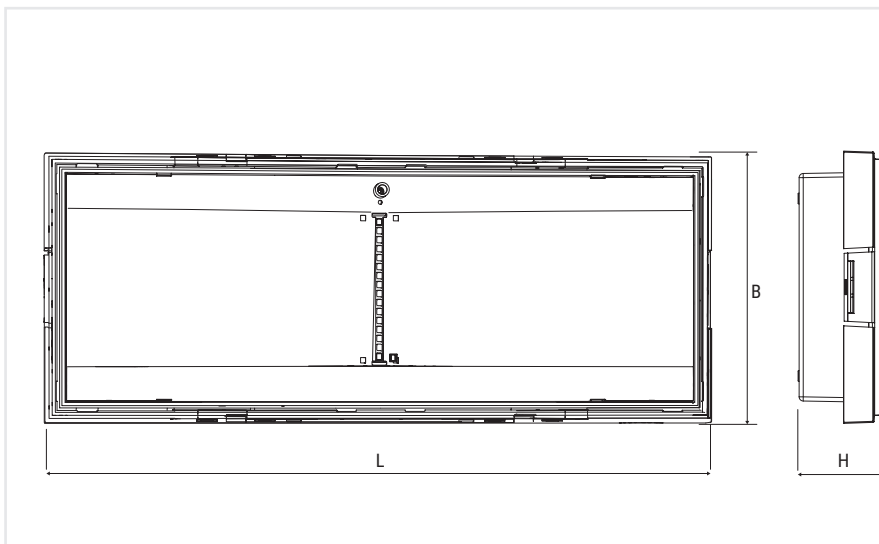

ESEMPIO DI SANIFICAZIONE INIZIALE EXAMPLE OF INITIAL SANITISATION

Dimensioni ambiente / Room size		
m ³	m ²	h
20	8	2,5
40	16	5
80	32	10
125	50	15
180	75	22

Dimensioni Dimensions mm			Distanza visibilità Distance of visibility (DV)
L	B	H	
325	130	45	25 m

Prestazioni secondo EN 1838 / Performance according to EN 1838

NORMA UNI EN 1838	Altezza apparecchio Height	Interasse fra gli apparecchi Centre distance VIE DI ESODO - ESCAPE ROUTES		Area illuminata da ogni apparecchio Illuminated surface area GRANDI AREE / LARGE AREAS	
	(m)	Parete / Wall (m)	Plafone / Ceiling (m)	Parete / Wall (m)	Plafone / Ceiling (m)
	2.5	8	-	6x8	-
3	-	10	-	9x10	
		illuminamento >1lx a pavimento lungo la linea centrale senza riflessioni Emax/Emin <40 lighting >1lx at floor level along the centre line without reflection Emax/Emin <40		illuminamento >0,5lx a pavimento senza riflessioni Emax/Emin <40 lighting >0,5lx at floor level without reflections Emax/Emin <40	
	Portata fino a Flow rate up to 8 m³/h	Tempo di sanificazione iniziale Initial sanitisation time 4h		Tempo di sanificazione iniziale Initial sanitisation time 15h	

INFINITA SanificaAria

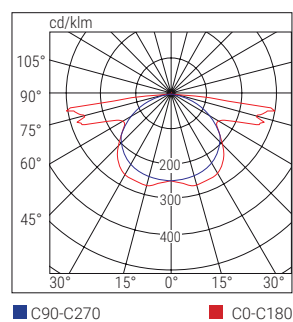

Prestazioni riferite al modello Cod. **19451UV** 500lm installato a parete - Flusso di sanificazione 3
Performance with reference to wall mounting luminaire Cod. **19451UV** 500lm - Sanitisation flow 3

Cod.	W eq.	Descrizione Description	Versione Version	Autonomia Autonomy h	Flusso Flux SE lm	Flusso Flux SA lm	Flusso di Sanificazione Sanitisation flow rate m³/h			Assorb. Absorbed Power W		Note Notes	
							1	2	3				
CT	19450UV	24	INFIN RTI SE CT L UVOXY	SE	1/1.5/2/3/8	250/170/130/90/40	-	2.5	5	8	1	10	
	19451UV	24GL	INFIN RTI SE CT XL UVOXY	SE	1/1.5/2/3/8	500/340/260/180/70	-	2.5	5	8	2.6	10	
	19452UV	24	INFIN RTI SA CT L UVOXY	SE/SA	1/1.5/2/3/8	250/170/130/90/40	90	2.5	5	8	1.8	10	
	19453UV	24GL	INFIN RTI SA CT XL UVOXY	SE/SA	1/1.5/2/3/8	500/340/260/180/70	250	2.5	5	8	4.8	10	
	19460UV	36GL	INF RTI SA CT GL UVOXY	SE/SA	1/1.5/2/3/8	1000/680/525/370/145	250	2.5	5	8	1.8	10	

Gli apparecchi CT possono integrare dispositivi opzionali per l'espansione ad altri sistemi: Modulo LG cod.15036 - Modulo LGFM Cod.15037 - Modulo DALI cod.15038
CT luminaires can integrate optional devices for expansion to other systems: LG Module code 15036 - LGFM Module code 15037 - DALI Module code 15038

ACCESSORI - in dotazione / ACCESSORIES - included

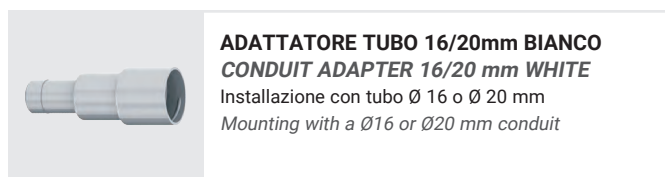
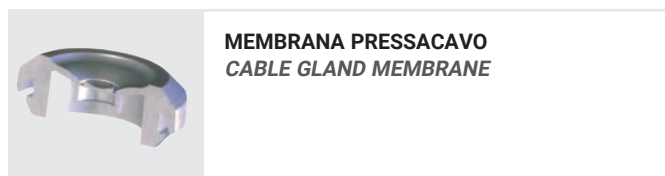

Infinita SanificaAria

emergenza / emergency

ACCESSORI E RICAMBI - da ordinare separatamente



RICAMBIO CARTUCCIA SANIFICANTE
SPARE PART PURIFICATION CARTRIDGE
Durata 12 mesi, con utilizzo continuo 24h/giorno
Duration 12 months, with continuous use 24h/day
Cod. 26723



STAFFA 45°
45° BRACKET
Cod. 18590



SCHERMO BANDIERA
EDGE MOUNTED SCREEN
Cod. 4681



SOSPENSIONE TIGES
SUSPENDED MOUNTING RODS
250 - 500 - 1000 mm
Cod. 4315 (250mm) - 4316 (500mm)
4317 (1000mm)



STAFFA FISSAGGIO BANDIERA
EDGE MOUNTING FIXING BRACKET
Cod. 18585



MODULO LG - LGFM - DALI
LG - LGFM - DALI MODULE
LG - Cod. 15036
LGFM - Cod. 15037
DALI - Cod. 15038

LG
LGFM
DALI



GANCI PER SOSPENSIONE
SUSPENDED MOUNTING HOOKS
Cod. 3723



CENTRALE CABLECOM CONNECT CBL
CABLECOM CONNECT CBL CONTROL UNIT
Cod. 20151

AT-CBL

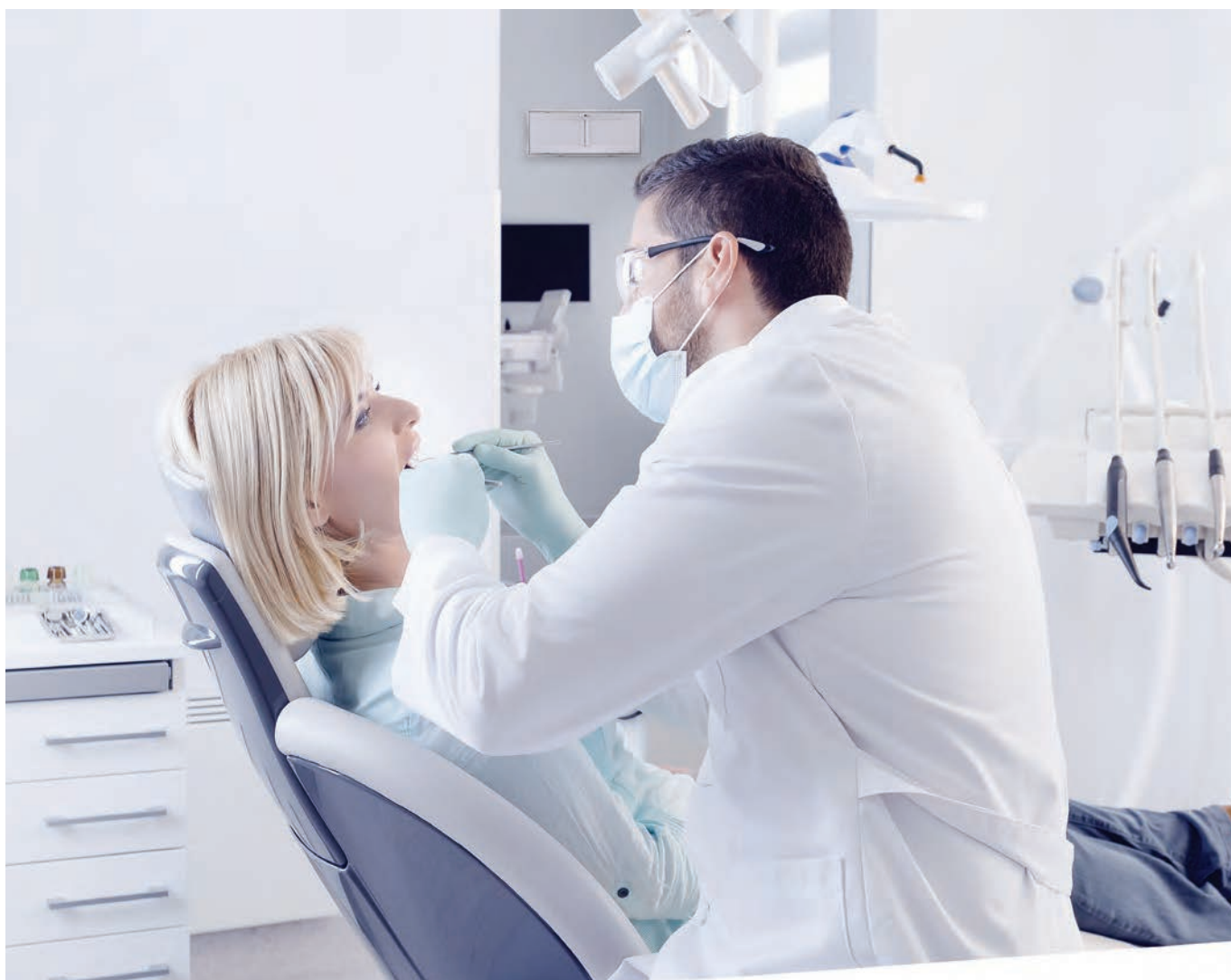



Infinita X5

emergenza / emergency



WEB CATALOGUE



IP65

IK08



850°



CTS - HT

+40°C
-20°C



+40°C
0°C

Caratteristiche

Installazioni parete, plafone, incasso, controsoffitto, sospensione, sospensione con Tiges

Corpo Policarbonato, bianco RAL 9003

Ottica Lenti in policarbonato trasparente

Schermo Policarbonato trasparente

Conformità EN 60598-1, EN 60598-2-2, EN 60598-2-22, UNI EN 1838, UNI 11222, EN 62034

Applicazioni

Industriale, terziario, civile, ospedali, Hotel, scuole, uffici, zone Altorischio

Characteristics

Mounting Wall, ceiling, recessed, false ceiling, suspended, suspended with rods

Housing Polycarbonate, white RAL 9003
Optics Clear polycarbonate lenses

Screen Clear polycarbonate

Compliance EN 60598-1, EN 60598-2-2, EN 60598-2-22, UNI EN 1838, UNI 11222, EN 62034

Applications

Industrial, service sectors, residential, hospitals, hotels, schools, offices, high-risk areas

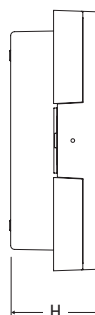
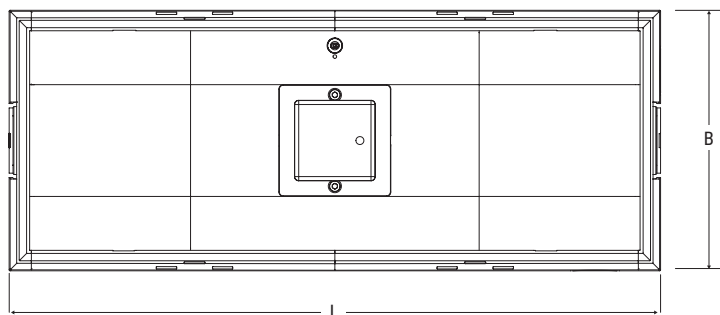

Dimensioni
Dimensions
mm

L	B	H
325	130	45

Prestazioni secondo EN 1838 / Performance according to EN 1838

Lente Lens	Altezza apparecchio Height	Interasse fra gli apparecchi Centre distance VIE DI ESODO - ESCAPE ROUTES		Area illuminata da ogni apparecchio Illuminated surface area GRANDI AREE / LARGE AREAS	
	(m)	Parete / Wall (m)	Plafone / Ceiling (m)	Parete / Wall (m)	Plafone / Ceiling (m)
Lungaluce 3m	3	-	11	-	-
Lungaluce 7m	7	-	28	-	-
Largaluce 3m	3	-	-	-	7X7
Largaluce 7m	7	-	-	-	20x20
Altorischio	7	-	-	-	Ø3m - 30lx

illuminamento >1lx a pavimento lungo la linea centrale senza riflessioni Emax/Emin <40 lighting >1lx at floor level along the centre line without reflection Emax/Emin <40	illuminamento >0,5lx a pavimento senza riflessioni Emax/Emin <40 lighting >0,5lx at floor level without reflections Emax/Emin <40
---	--

Prestazioni riferite all'apparecchio Cod. 19461 1200lm
Performance with reference to luminaire Cod. 19461 1200lm

Coefficiente di manutenzione 0.8
Maintenance coefficient 0.8

ALTORISCHIO 87%

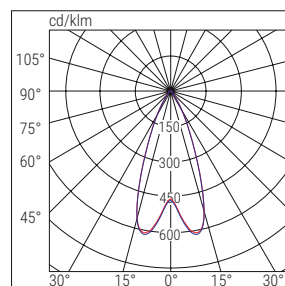

LUNGALUCE 3m 85%

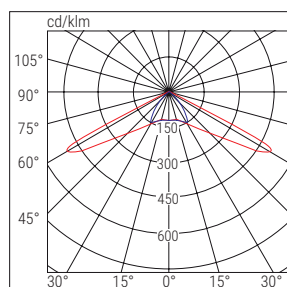

■ C0-C180 ■ C90-C270

LUNGALUCE 7m 85%

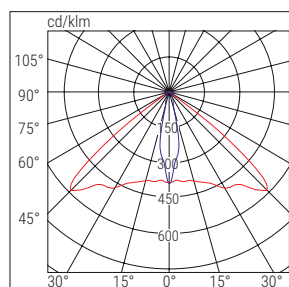

■ C0-C180 ■ C90-C270

LARGALUCE 3m 90%

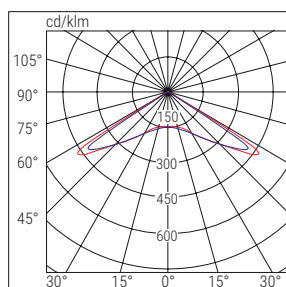

■ C0-C180 ■ C90-C270

LARGALUCE 7m 87%

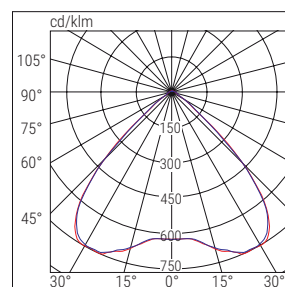

■ C0-C180 ■ C90-C270

	Cod.	W eq.	Descrizione Description	Versione Version	Autonomia Autonomy h	Flusso Flux SE lm	Flusso Flux SA lm	Assorbimento Absorbed Power		Note Notes	
								DC	AC		
CT	19461	36GL	INFINITA GL 5X CT SE/SA	SE/SA	1/1.5/2/3/8	1200/800/650/460/180	250		6.6W		
	19471	36GL	INFINITA 5X CT SE/SA	SE/SA	1/1.5/2/3/8	1500/1000/750/550/200	250		6.6W		
Gli apparecchi CT possono integrare dispositivi opzionali per l'espansione ad altri sistemi: Modulo LG cod.15036 - Modulo LGFM Cod.15037 - Modulo DALI cod.15038 CT luminaires can integrate optional devices for expansion to other systems: LG Module code 15036 - LGFM Module code 15037 - DALI Module code 15038											
CTS	LG230										
	31172	36GL	INFINITA 5X LG230 SE/SA XL	SE/SA		1100	1100	11.4 W	12.4 VA		
	LG24										
32112	36GL	INFINITA 5X LG24 SE/SA XL	SE/SA		500	1100	4.3 W	11.4 VA			
LG EPS											
31302	36GL	IINFINITA X5 LG EPS DALI XL	SE/SA		1100	1100		12.4 VA			
HT	31176	36GL	INFINITA 5X HT XL	HT		1100	1100	10.5 W	10.8 VA		

SEGUE / NEXT >

Infinita X5

emergenza / emergency

ACCESSORI - in dotazione / ACCESSORIES - included

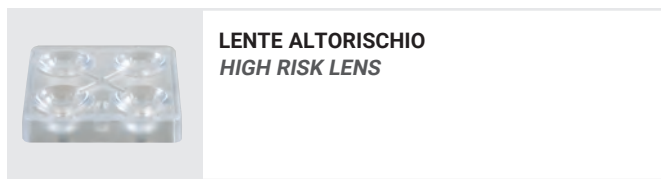

LENTE ALTORISCHIO
HIGH RISK LENS

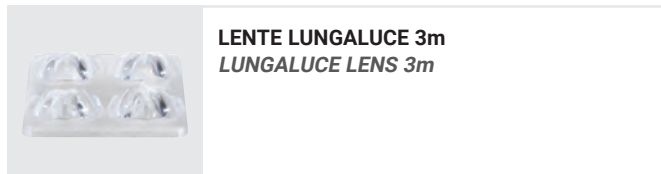

LENTE LUNGALUCE 3m
LUNGALUCE LENS 3m

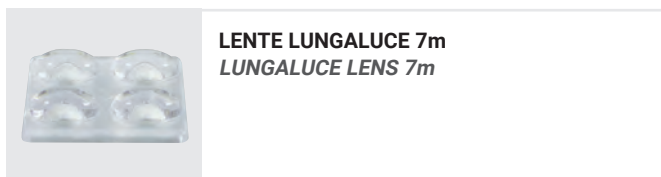

LENTE LUNGALUCE 7m
LUNGALUCE LENS 7m



LENTE LARGALUCE 3m
LARGALUCE LENS 3m
Montata di serie / Fitted as standard



LENTE LARGALUCE 7m
LARGALUCE LENS 7m

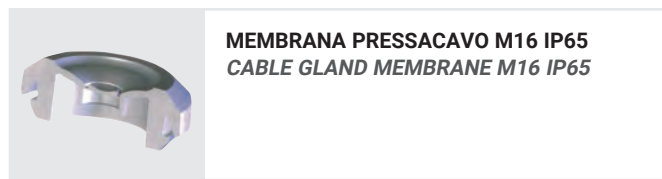

MEMBRANA PRESSACAVO M16 IP65
CABLE GLAND MEMBRANE M16 IP65

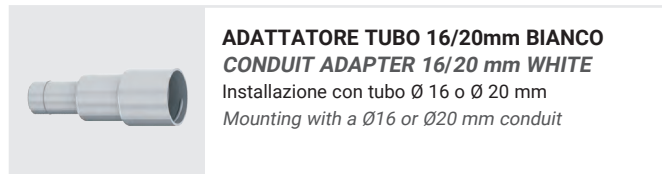

ADATTATORE TUBO 16/20mm BIANCO
CONDUIT ADAPTER 16/20 mm WHITE
Installazione con tubo Ø 16 o Ø 20 mm
Mounting with a Ø16 or Ø20 mm conduit

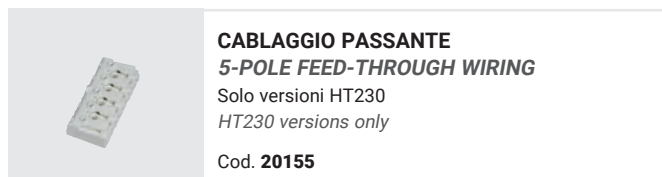

CABLAGGIO PASSANTE
5-POLE FEED-THROUGH WIRING
Solo versioni HT230
HT230 versions only
Cod. **20155**

ACCESSORI - da ordinare separatamente / ACCESSORIES - to be ordered separately

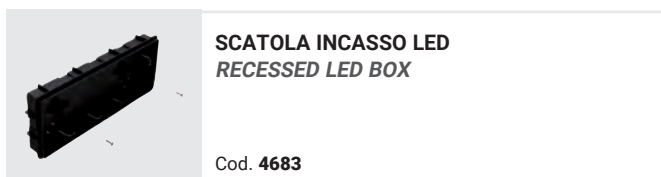

SCATOLA INCASSO LED
RECESSED LED BOX
Cod. **4683**



GRIGLIA DI PROTEZIONE
PROTECTIVE GRID
440 x 215 x 99 mm
Cod. **3912**

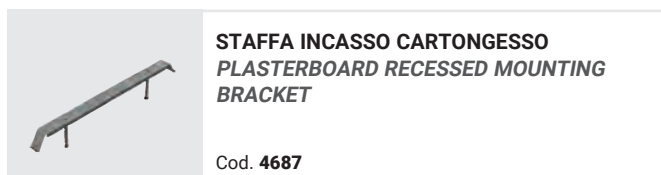

STAFFA INCASSO CARTONGESSO
PLASTERBOARD RECESSED MOUNTING BRACKET
Cod. **4687**



SOSPENSIONE TIGES
SUSPENDED MOUNTING RODS
250 - 500 - 1000 mm
Cod. **4315** (250mm) - **4316** (500mm)
4317 (1000mm)

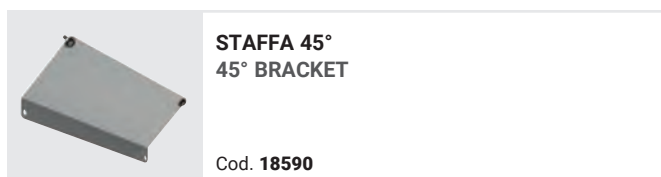

STAFFA 45°
45° BRACKET
Cod. **18590**

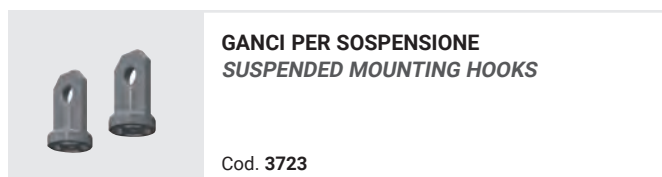

GANCI PER SOSPENSIONE
SUSPENDED MOUNTING HOOKS
Cod. **3723**

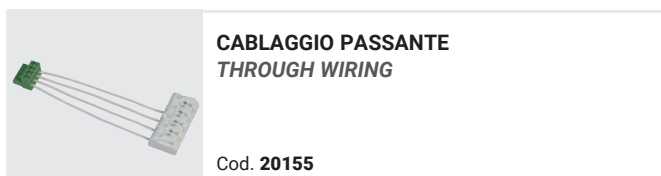

CABLAGGIO PASSANTE
THROUGH WIRING
Cod. **20155**



MODULO / MODULE LG - LGFM - DALI
Solo per apparecchi CT / *CT version only*
LG - Cod. **15036**
LGFM - Cod. **15037**
DALI - Cod. **15038**

LG
LGFM
DALI



047 apparecchi / luminaires

Formula 65

emergenza / emergency



Caratteristiche

Installazioni parete, soffitto, incasso, controsoffitto

Corpo Policarbonato, bianco RAL 9003

Ottica Simmetrica bianca

Schermo Policarbonato trasparente

Conformità EN 60598-1, EN 60598-2-2, EN 60598-2-22, UNI EN 1838, UNI 11222, EN62034

Applicazioni

Industriale, terziario, civile, ospedali, Hotel, scuole, uffici

Characteristics

Mounting Wall, ceiling, recessed, false ceiling

Housing Polycarbonate, white RAL 9003

Optics Symmetrical, white

Screen Clear polycarbonate

Compliance EN 60598-1, EN 60598-2-2, EN 60598-2-22, UNI EN 1838, UNI 11222, EN62034

Applications

Industrial, service sectors, residential, hospitals, hotels, schools, offices

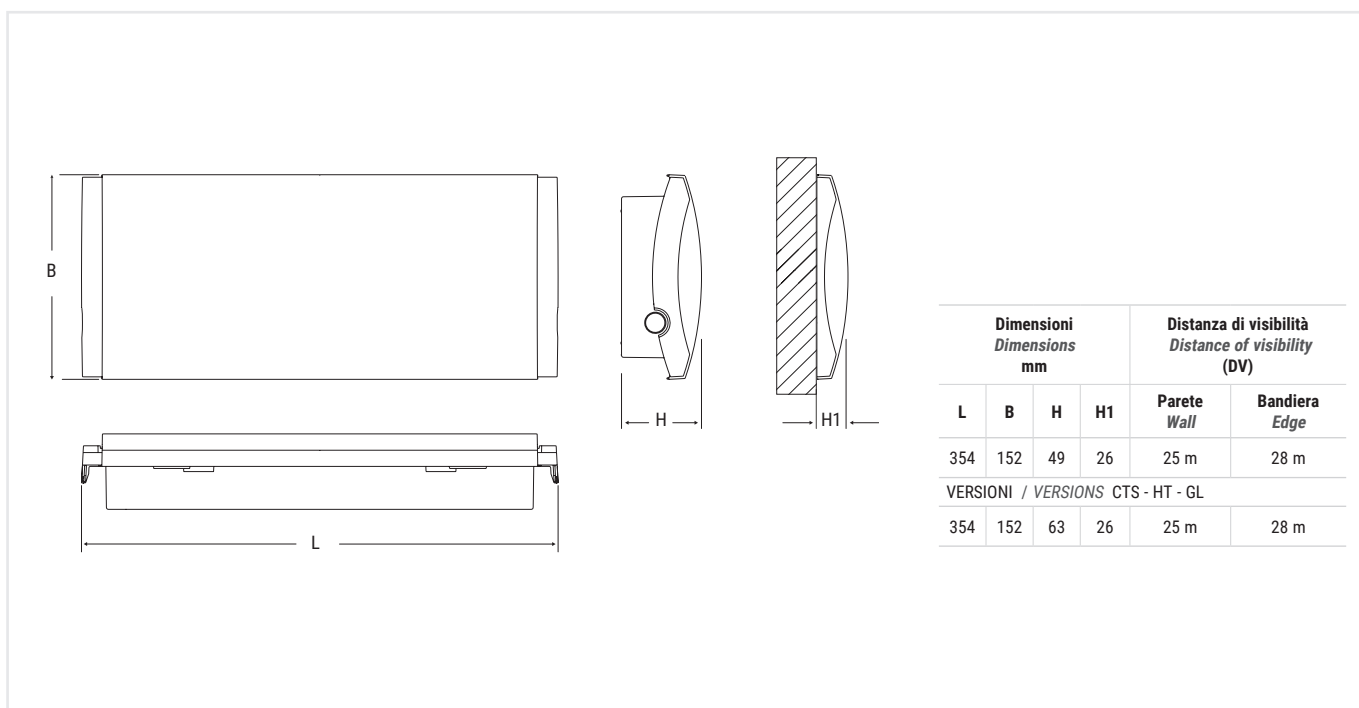

Prestazioni secondo EN 1838 / Performance according to EN 1838

Altezza apparecchio Height	Interasse fra gli apparecchi Centre distance VIE DI ESODO - ESCAPE ROUTES		Area illuminata da ogni apparecchio Illuminated surface area GRANDI AREE / LARGE AREAS	
	(m)	Parete / Wall (m)	Plafone / Ceiling (m)	Parete / Wall (m)
2,5	13	-	10x12	-
3	-	20	-	12x16
7	-	28	-	16x22
illuminamento >1lx a pavimento lungo la linea centrale senza riflessioni Emax/Emin <40 lighting >1lx at floor level along the centre line without reflection Emax/Emin <40			illuminamento >0,5lx a pavimento senza riflessioni Emax/Emin <40 lighting >0,5lx at floor level without reflections Emax/Emin <40	

FORMULA 65

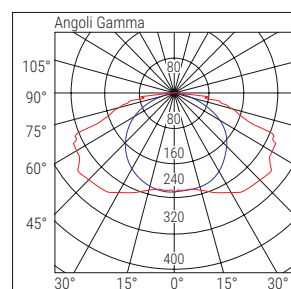

■ C90-C270 ■ C0-C180

Prestazioni riferite all'apparecchio Cod. 19430 1700 lm
Performance with reference to luminaire Cod. 19430 1700 lm

Coefficiente di manutenzione 0,8
Maintenance coefficient 0,8

	Cod.	W eq.	Descrizione Description	Versione Version	Autonomia Autonomy h	Flusso Flux SE lm	BOOSTER BATTERY Flusso / Flux SE lm >50%	Assorbimento Absorbed Power		Note Note
								Flusso Flux SA lm	DC	
TR	19200N	8	F65 LED 8W IP65 SE 1/3	SE	1/3	150/70		-	2.6W	
	19202N	11	F65 LED 11W IP65 SE 1/3	SE	1/3	200/80		-	2.6W	
	19204N	11	F65 LED 11W IP65 SA 1/3	SE/SA	1/3	200/80		240	3.9W	
	19206N	24	F65 LED 24W IP65 SE 1/3	SE	1/3	450/160		-	2.6W	
	19208N	24	F65 LED 24W IP65 SA 1/3	SE/SA	1/3	450/160		240	3.9W	
	19210N	36	F65 LED 36W IP65 SE 1/3	SE	1/3	700/240		-	2.6W	
	19212N	36	F65 LED 36W IP65 SA 1/3	SE/SA	1/3	700/240		240	3.9W	
	19430	36GL	F65 LED GL IP65 SE 1/1.5/3	SE	1/1.5/3	1700/1100/700		-	1.7W	
19431	36GL	F65 LED GL IP65 SA 1/1.5/3	SE/SA	1/1.5/3	1700/1100/700		300	3.8W		
AT	R0818	8	F65 LED 8W IP65 AT SE	SE	1/1.5/2/3/8	180/130/100/70/30		-	1.9W	
	R1124	24	F65 LED 24W IP65 AT SE	SE	1/1.5/2/3/8	450/300/230/160/70		-	1.9W	
	R1124SA	36	F65 LED 24W IP65 AT SA	SE/SA	1/1.5/2/3/8	450/300/230/160/70		250	4W	
	R2436	36	F65 LED 36W IP65 AT SE	SE	1/1.5/2/3/8	700/450/350/240/100		-	1.9W	
	R2436SA	36	F65 LED 36W IP65 AT SA	SE/SA	1/1.5/2/3/8	700/450/350/240/100		250	4W	
	19432	36GL	F65 LED GL IP65 AT AR SE	SE	1/1.5/2/3/8	1500/1000/750/550/190	RA06 BATTERY	-	3.4W	
	19433	36GL	F65 LED GL IP65 AT AR SA	SE/SA	1/1.5/2/3/8	1500/1000/750/550/190	RA06 BATTERY	500	6.6W	
CT	19290	24	F65LED 24W IP65 CT SE LF	SE	1/1.5/2/3/8	300/220/180/120/50		-	1.9W	10 YEAR
	19291	24GL	F65LED 24W IP65 CT SE	SE	1/1.5/2/3/8	500/350/280/200/80		-	1.9W	10 YEAR
	19292	36GL	F65LED 36W IP65 CT SE	SE	1/1.5/2/3/8	800/550/420/300/150		-	1.9W	10 YEAR
	19293	36GL	F65LED 36GL IP65 CT SE	SE	1/1.5/2/3/8	1000/700/520/400/170		-	1.9W	10 YEAR
	19294	24GL	F65LED 24W IP65 CT SA	SE/SA	1/1.5/2/3/8	500/350/280/200/50		250	4W	10 YEAR
	19295	36GL	F65LED 36W IP65 CT SA	SE/SA	1/1.5/2/3/8	800/550/420/300/150		250	4W	10 YEAR
	19296	36GL	F65LED 36GL IP65 CT SA	SE/SA	1/1.5/2/3/8	1000/700/520/400/170		250	4W	10 YEAR
	19434	36GL	F65 LED GL IP65 CT AR SE	SE	1/1.5/2/3/8	1500/1000/750/550/190	RA06 BATTERY	-	3.4W	10 YEAR
	19435	36GL	F65 LED GL IP65 CT AR SA	SE/SA	1/1.5/2/3/8	1500/1000/750/550/190	RA06 BATTERY	500	6.6W	10 YEAR

Gli apparecchi CT possono integrare dispositivi opzionali per l'espansione ad altri sistemi: Modulo LG cod.15036 - Modulo LGFM Cod.15037 - Modulo DALI cod.15038
CT luminaires can integrate optional devices for expansion to other systems: LG Module code 15036 - LGFM Module code 15037 - DALI Module code 15038



SEGUE / NEXT >

Formula 65



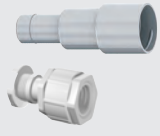

emergenza / emergency

	Cod.	W eq.	Descrizione Description	Flusso Flux SE lm	Flusso Flux SA lm	Assorbimento Absorbed Power		Note Note	
						DC	AC		
CTS	LG230								
	31124	8	F65 LED 8W LGS230	400	400	4.1W	8.5VA		
	31125	11	F65 LED 11W LGS230	600	600	6.4W	8.1VA		
	31150	24	F65 LED 24W LGS230	1000	1000	10.4W	12VA		
	31122	36	F65 LED LGS230 GL LS-UV	1600	1600	15W	15.9VA		
	LG24								
	32094	8	F65 LED 8W SE LGS24	400	400	3.8W			
	32091	8	F65 LED 8W LGS24 SA LS-UV	400	1600	4.3W	15.2VA		
	32115	36	F65 LED LGS24 GL LS-UV	800/1600	1600	8/16W			
	LG EPS								
	31303	8	F65 8W LED LG EPS DALI	400	400		8,5VA		
	31304	24	F65 24W LED LG EPS DALI	1000	1000		12VA		
31305	36GL	F65 36W LED LG EPS DALI	1600	1600		15,9VA			
HT	17435	24GL	F65 LED 8W HT IP65	400	400	4.4W	8.9VA		
	17436	24GL	F65 LED 11W HT IP65	600	600	6.1W	6.4VA		
	17437	36GL	F65 LED 24W HT IP65	1000	1000	10.2W	10.4VA		
	17438	36GL	F65 LED 36W HT IP65	1600	1600	14.3W	14.5VA		

ACCESSORI - in dotazione / ACCESSORIES - included

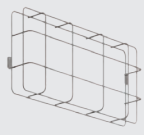
 <p>ADATTATORE TUBO 16-20 mm BIANCO CONDUIT ADAPTER 16/20 mm WHITE Installazione con tubo Ø 16 o Ø 20 mm Mounting with a Ø16 or Ø20 mm conduit Pressatubo M20 / cable conduit gland M20</p>	 <p>ADESIVI SX/DX/BASSO LH/RH/DOWN STICKERS Solo per versioni SA / SA versions only Cod. 19044</p>
 <p>SCATOLA DA INCASSO + CORNICI / RECESSED BOX + FRAMES Per installazione ad incasso / For recessed mounting Solo nelle Versioni TR esclusi Cod. 19430 - 19431 che utilizzano la Scatola incasso Cod. 19048 da ordinare separatamente Only TR version Cod. 19430 - 19431 excluding, which use the Recessed box Code 19048 to be ordered separately Cod. 19040</p>	

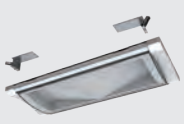
ACCESSORI - da ordinare separatamente / ACCESSORIES - to be ordered separately

 <p>BOOSTER BATTERY Compatibile con / Compatible with Cod. 19432 - 19433 Cod. RA06 - LiFe 9.6V 1.5Ah</p>	 <p>GRIGLIA DI PROTEZIONE PROTECTIVE GRID 440x215x99 mm Cod. 3912</p>
 <p>SCATOLA DA INCASSO + CORNICI RECESSED BOX + FRAMES Per installazione ad incasso / For recessed mounting Cod. 19040 (escluso versione GL/excluding GL version) Cod. 19048</p>	 <p>MODULO / MODULE LG - LGFM - DALI Solo per apparecchi CT / CT version only LG - Cod. 15036 LGFM - Cod. 15037 DALI - Cod. 15038</p>
 <p>STAFFA CONTROSOFFITTO EX EX FALSE CEILING BRACKET Incasso in controsoffitto - Foro incasso: 370 x 130 mm Recessed mounting - hole: 370 x 130 mm Cod. 19041 (escluso versione GL/excluding GL version) Cod. 19049 (solo versione GL/only GL version)</p>	 <p>TELECOMANDO INIBIT RM RM INIBIT REMOTE CONTROL RM solo per apparecchi TR e AT equipaggiati di modulo RM / RM only for TR and AT devices equipped with RM module Cod. Ord. 2730</p>

ACCESSORI - da ordinare separatamente / **ACCESSORIES** - to be ordered separately



STAFFA A PARETE PER BANDIERA
EDGE MOUNTING WALL BRACKET

Cod. **19045**



MODULO RM / RM MODULE
Rest Mode

Cod. **15048**

TR
AT



SCHERMI BANDIERA
EDGE MOUNTED SCREENS

Serigrafia su policarbonato trasparente
Screen print on clear polycarbonate

Cod. **19042** (SX-DX/LH-RH) Cod. **19043** (BASSO/DOWN)



Formula 65 SanificaAria

emergenza / emergency



Caratteristiche

Installazioni parete, soffitto

Corpo ABS, bianco RAL 9003

Ottica Simmetrica bianca

Schermo Policarbonato trasparente

Conformità EN60598-1, EN60598-2-22, EN60335-2-65, ISO 15714, 2014/30/UE, 2014/35/UE

Applicazioni

Industriale, terziario, ospedali, attività commerciali, negozi, ristoranti, uffici, scuole

Emergency features

Mounting wall, ceiling

Housing ABS, white RAL 9003

Optics Symmetrical, white

Screen Clear polycarbonate

Compliance EN60598-1, EN60598-2-22, EN60335-2-65, ISO 15714, 2014/30/EU, 2014/35/EU

Applications

Industry, service sector, hospitals, commercial activities, shops, restaurants, offices, schools

Caratteristiche Sanificatore Specifications of the Air Purifier

UV-C wavelength 254nm

Sanitisation flow rate 8 m³/h

UV-C power 7W

UV-C radiation power 2.4W

Technical drawings showing the dimensions of the air purifier: L (length), B (width), and H (height).

ESEMPIO DI SANIFICAZIONE INIZIALE EXAMPLE OF INITIAL SANITISATION

Dimensioni ambiente / Room size		
m ³	m ²	h
20	8	2.5
40	16	5
80	32	10
125	50	15
180	75	22

Dimensioni Dimensions mm			Distanza di visibilità Distance of visibility (DV)	
L	B	H	Parete Wall	Bandiera Edge
354	152	63.4	25 m	28 m

Prestazioni secondo EN 1838 / Performance according to EN 1838

NORMA UNI EN 1838	Altezza apparecchio Height	Interasse fra gli apparecchi Centre distance VIE DI ESODO - ESCAPE ROUTES		Area illuminata da ogni apparecchio Illuminated surface area GRANDI AREE / LARGE AREAS	
	(m)	Parete / Wall (m)	Plafone / Ceiling (m)	Parete / Wall (m)	Plafone / Ceiling (m)
	2.5	11	-	8x12	-
	3	-	18	-	10x16
	illuminamento >1lx a pavimento lungo la linea centrale senza riflessioni Emax/Emin <40 lighting >1lx at floor level along the centre line without reflection Emax/Emin <40			illuminamento >0,5lx a pavimento senza riflessioni Emax/Emin <40 lighting >0,5lx at floor level without reflections Emax/Emin <40	

FORMULA65 SanificaAria

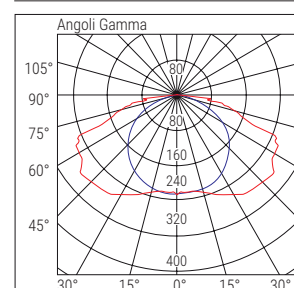

■ C90-C270 ■ C0-C180

	Portata fino a Flow rate up to 8 m³/h	Tempo di sanificazione iniziale Initial sanitisation time 5h	Tempo di sanificazione iniziale Initial sanitisation time 30h
--	---	--	---

Prestazioni riferite al modello 19430UV 1100lm installato a parete - Flusso di sanificazione 3
Performance with reference to luminaire 19430UV 1100lm installed on the wall - Sanitization flow 3

	Cod.	W eq.	Descrizione Description	Versione Version	Autonomia Autonomy h	Flusso Flux SE lm	Flusso SA lm	Flusso di Sanificazione Sanitisation flow rate m³/h			Assorbimento Absorbed Power W	
								1	2	3		
TR	19430UV	36	F65 LED SE UVOXY	SE	1.5	1100	-	2.5	5	8	2	10
	19431UV	36	F65 LED SA UVOXY	SE/SA	1.5	1100	250	2.5	5	8	5	10
AT	19432UV	36	F65 LED AT SE UVOXY	SE	1/1.5/2/3/8	1200/830/600/450/170	-	2.5	5	8	2	10
	19433UV	36	F65 LED AT SA UVOXY	SE/SA	1/1.5/2/3/8	1200/830/600/450/170	250	2.5	5	8	5	10

ACCESSORI - in dotazione / ACCESSORIES - included

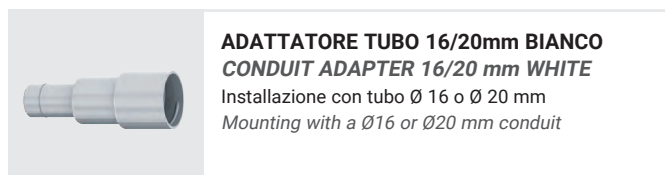

ACCESSORI - da ordinare separatamente / ACCESSORIES - to be ordered separately





Caratteristiche

- Installazioni** Parete, incasso
- Corpo** Policarbonato, bianco RAL 9003
- Ottica** Alluminio antiabbagliamento
- Schermo** Policarbonato trasparente
- Conformità** EN 60598-1, EN 60598-2-2, EN 60598-2-22, UNI EN 1838, UNI 11222, EN 62034

Applicazioni

Industriale, terziario, civile, ospedali, Hotel, scuole, uffici, anche per applicazioni in ambienti di design

Characteristics

- Mounting** Wall, recessed
- Housing** Polycarbonate, white RAL 9003
- Optics** Anti-glare aluminium
- Screen** Clear polycarbonate
- Compliance** EN 60598-1, EN 60598-2-2, EN 60598-2-22, UNI EN 1838, UNI 11222, EN 62034

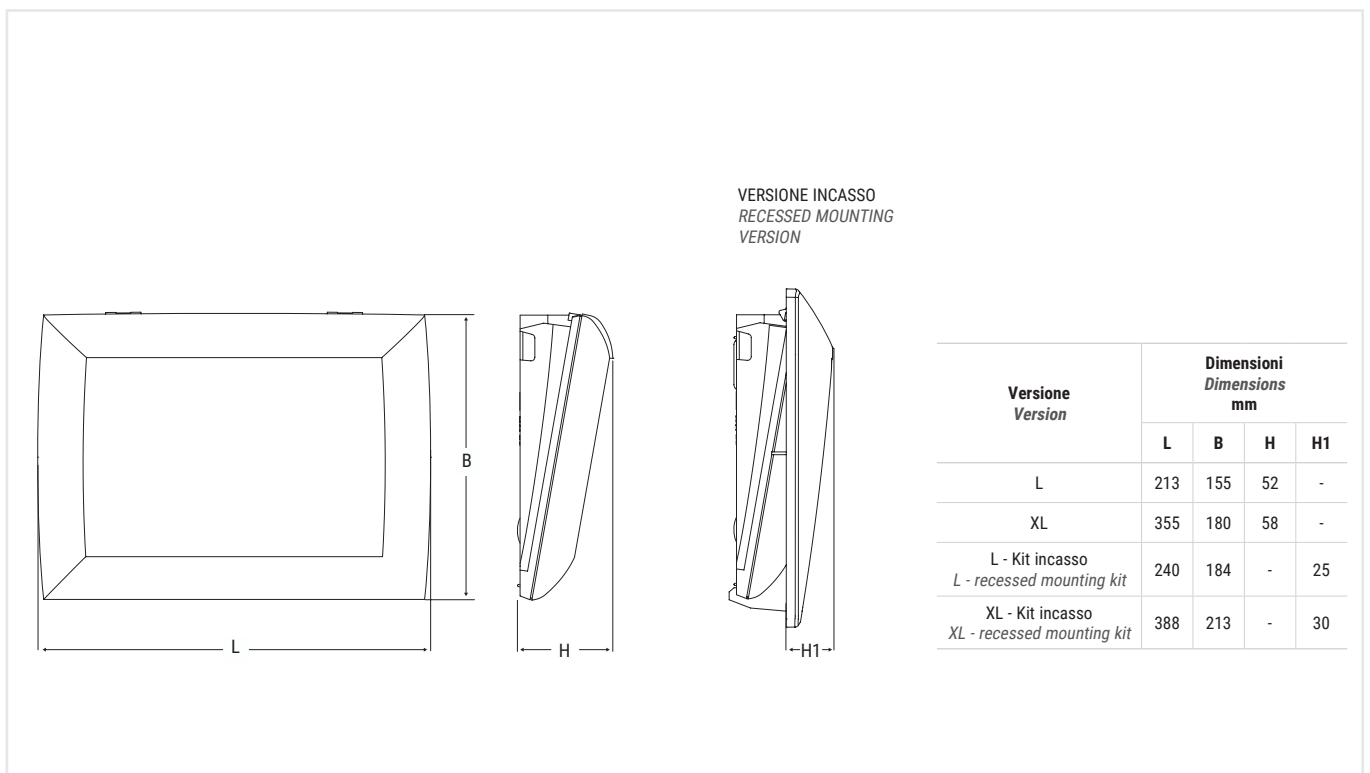

Applications

Industrial, service sectors, residential, hospitals, hotels, schools, offices, also for applications in design environments



Versione Version	Dimensioni Dimensions mm			
	L	B	H	H1
L	213	155	52	-
XL	355	180	58	-
L - Kit incasso L - recessed mounting kit	240	184	-	25
XL - Kit incasso XL - recessed mounting kit	388	213	-	30

Prestazioni secondo EN 1838 / Performance according to EN 1838

Lente Lens	Altezza apparecchio Height  (m)	Interasse fra gli apparecchi Centre distance VIE DI ESODO - ESCAPE ROUTES 		Area illuminata da ogni apparecchio Illuminated surface area GRANDI AREE / LARGE AREAS 	
		Parete / Wall (m)	Plafone / Ceiling (m)	Parete / Wall (m)	Plafone / Ceiling (m)
Presente / Present	2.5	16	-	-	-
Rimossa / Removed	2.5	-	-	7x10	-
illuminamento >1lx a pavimento lungo la linea centrale senza riflessioni Emax/Emin <40 lighting >1lx at floor level along the centre line without reflection Emax/Emin <40			illuminamento >0,5lx a pavimento senza riflessioni Emax/Emin <40 lighting >0,5lx at floor level without reflections Emax/Emin <40		

Prestazioni riferite all'apparecchio Cod. 19421 680lm
Performance with reference to luminaire Cod. 19421 680lm

Coefficiente di manutenzione 0.8
Maintenance coefficient 0.8

CON LENTE / WITH LENS

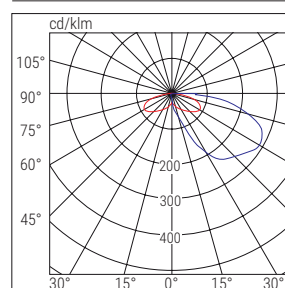

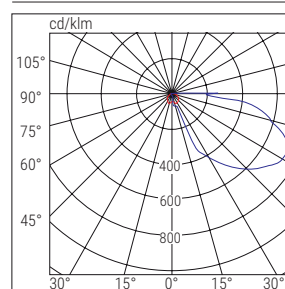

■ C90-C270 ■ C0-C180

SENZA LENTE WITHOUT LENS



■ C90-C270 ■ C0-C180

	Cod.	W eq.	Descrizione Description	Versione Version	Autonomia Autonomy h	Flusso Flux SE lm	Flusso Flux SA lm	Assorbimento Absorbed Power		Note Notes
								DC	AC	
CT	19420	24	METRICA LED CT SA L	SE/SA	1/1.5/2/3/8	340/230/170/120/50	200		4 W	
	19421	24GL	METRICA LED CT SA XL	SE/SA	1/1.5/2/3/8	680/460/350/250/90	200		5 W	
Gli apparecchi CT possono integrare dispositivi opzionali per l'espansione ad altri sistemi: Modulo LG cod.15036 - Modulo LGFM Cod.15037 - Modulo DALI cod.15038 The CT luminaires can integrate optional devices for expansion to other systems: LG Module cod.15036 - LGFM Module cod.15037 - DALI Module cod.15038										
CTS	LG230									
	31121	24	METRICA LED LG230 L LS-UV	SE/SA		550	550	6.8 W	8.6 VA	
	31123	36GL	METRICA LED LG230 XL LS-UV	SE/SA		1100	1100	11.3 W	12.6 VA	
	LG24									
HT	32090	24	METRICA LED LG24 L LS-UV	SE/SA		260	550	3 W	6.8 VA	
	32093	36GL	METRICA LED LG24 XL LS-UV	SE/SA		530	1100	4.3 W	11.1 VA	
HT	17423	24	METRICA LED HT L	HT		550	550	6.3 W	6.8 VA	
	17424	36GL	METRICA LED HT XL	HT		1100	1100	11 W	11.1 VA	

ACCESSORI - in dotazione / ACCESSORIES - included



PRESSATUBO PG16/PG20
CABLE CONDUIT GLAND PG16/PG20
Removibile per installazioni sopraporta
Removable for overhead mounting
Cod. 3727



ADESIVI SX/DX/BASSO
LH/RH/DOWN STICKERS
Cod. 12944 (Versione / Version L)
Cod. 12941 (Versione / Version XL)

ACCESSORI - da ordinare separatamente / ACCESSORIES - to be ordered separately

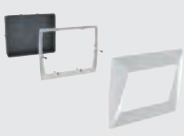

KIT INCASSO
RECESSED MOUNTING KIT
Cod. Ord. 12942 (Versione / Version L)
Cod. Ord. 12943 (Versione / Version XL)



MODULO / MODULE LG - LGFM - DALI
Solo per apparecchi CT / CT version only
LG - Cod. 15036
LGFM - Cod. 15037
DALI - Cod. 15038

Lumax 65

emergenza / emergency



Caratteristiche

Installazioni parete, plafone

Corpo Policarbonato, grigio RAL 7024

Schermo Policarbonato opale

Conformità EN 60598-1, EN 60598-2-22, UNI EN 1838, UNI 11222, EN 62034

Applicazioni

Indoor, outdoor, terziario civile in condomini, luce scale, corridoi, negozi, alberghi, ristoranti

Characteristics

Mounting Wall, ceiling

Housing Polycarbonate, grey RAL 7024

Screen Opal polycarbonate

Compliance EN 60598-1, EN 60598-2-22, UNI EN 1838, UNI 11222, EN 62034

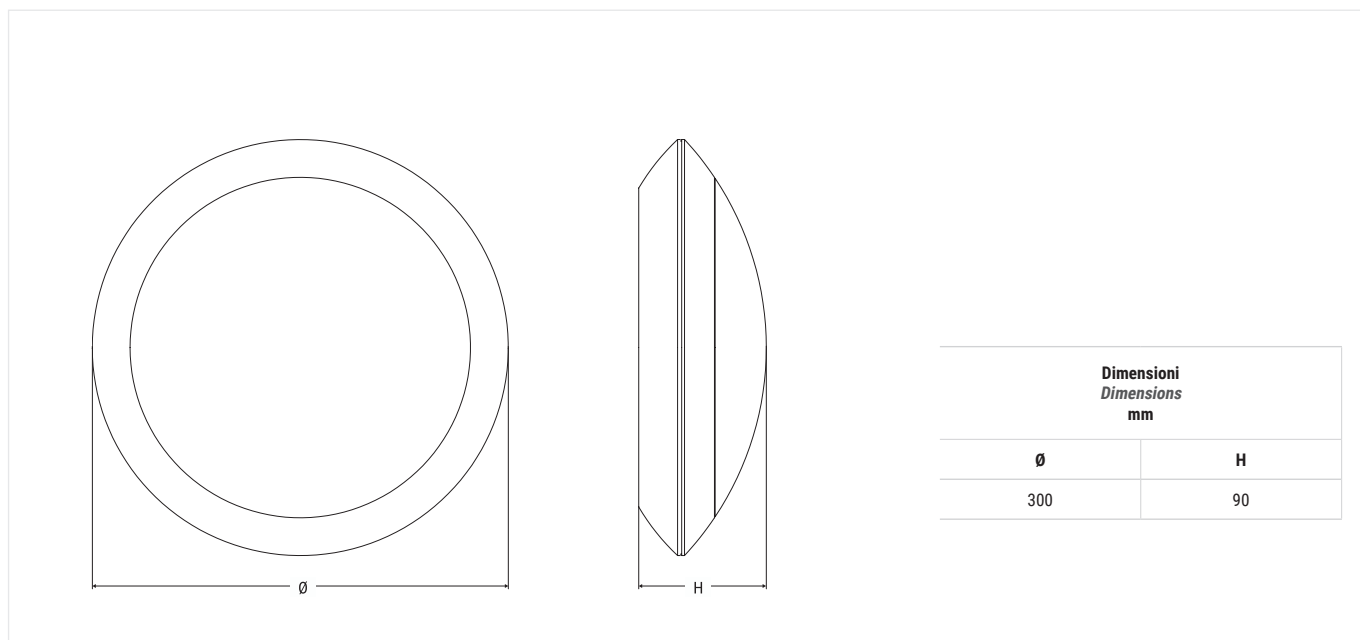

Applications

Indoor, outdoor, service sectors, residential buildings, stairwell lighting, corridors, shops, hotels, restaurants



056

Prestazioni secondo EN 1838 / Performance according to EN 1838

Altezza apparecchio Height 	Interasse fra gli apparecchi Centre distance VIE DI ESODO - ESCAPE ROUTES 		Area illuminata da ogni apparecchio Illuminated surface area GRANDI AREE / LARGE AREAS 	
	(m)	Parete / Wall (m)	Plafone / Ceiling (m)	Parete / Wall (m)
2.5	6	-	6x6	-
3	-	10	-	6x6

illuminamento >1lx a pavimento lungo la linea centrale senza riflessioni Emax/Emin <40
lighting >1lx at floor level along the centre line without reflection Emax/Emin <40

illuminamento >0,5lx a pavimento senza riflessioni Emax/Emin <40
lighting >0,5lx at floor level without reflections Emax/Emin <40



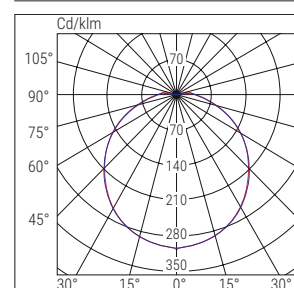



LUMAX 65



■ C0-C180 ■ C90-C270

Prestazioni riferite all'apparecchio Cod. 37126 278 lm
Performance with reference to luminaire Cod. 37126 278 lm

Coefficiente di manutenzione 0,8
Maintenance coefficient 0,8

	Cod.	W eq.	Descrizione Description	Versione Version	Autonomia Autonomy h	Flusso Flux SE lm	Flusso Flux SA lm	Assorbimento Absorbed Power		Note Notes	
								DC	AC (SE/SA)		
CT	37126	36GL	LUMAX65 GR SE/SA CT 4K	SE/SA/PS	1/1.5/2/3/8	340/227/227/170/68	1850		5/18W		
	37236	36GL	LUMAX65 GR SE/SA CT 4K MW	SE/SA/PS	1/1.5/2/3/8	340/227/227/170/68	1850		5/18W	 	
<p>Gli apparecchi CT possono integrare dispositivi opzionali per l'espansione ad altri sistemi: Modulo LG cod.15036 - Modulo LGFM Cod.15037 - Modulo DALI cod.15038 The CT luminaires can integrate optional devices for expansion to other systems: LG Module cod.15036 - LGFM Module cod.15037 - DALI Module cod.15038</p>											
CTS	LG230										
	31090	36GL	LUMAX65 GR LG230 SE/SA 4K	SE/SA			1850	1850	18.5W	20VA	
	31208	36GL	LUMAX65 GR LG230 SE/SA 4K MW	SE/SA			1850	1850	18.5W	20VA	
	LG24										
	32067	36GL	LUMAX65 GR LG24 SE/SA 4K	SE/SA			340	1850	4.3W	18.5VA	
	32122	36GL	LUMAX65 GR LG24 SE/SA 4K MW	SE/SA			340	1850	4.3W	18.5VA	
HT	31092	36GL	LUMAX65 GR HT 4K	HT			1850	1850	17W	18.5VA	
	31210	36GL	LUMAX65 GR HT 4K MW	HT			1850	1850	17W	18.5VA	

ACCESSORI - da ordinare separatamente / ACCESSORIES - to be ordered separately



MODULO LG - LGFM - DALI
LG - LGFM - DALI MODULE

LG - Cod. 15036
LGFM - Cod. 15037
DALI - Cod. 15038

LG

LGFM

DALI



Caratteristiche

- Installazioni** parete, plafone, bandiera
- Corpo** Policarbonato, bianco RAL 9003
- Ottica** PMMA a Riflessione Totale Interna
- Schermo** Policarbonato trasparente
- Conformità** EN 60598-1, EN 60598-2-22, EN 60598-2-2, EN 62034, UNI EN 1838, UNI 11222, EN 60598-2-22

Applicazioni

Industriale, terziario, civile, ospedali, musei, hotel

Characteristics



- Mounting** wall, ceiling, edge
- Housing** Polycarbonate, white RAL 9003
- Optics** PMMA Total Internal Reflection
- Screen** Clear polycarbonate
- Compliance** EN 60598-1, EN 60598-2-22, EN 60598-2-2, EN 62034, UNI EN 1838, UNI 11222, EN 60598-2-22

Applications

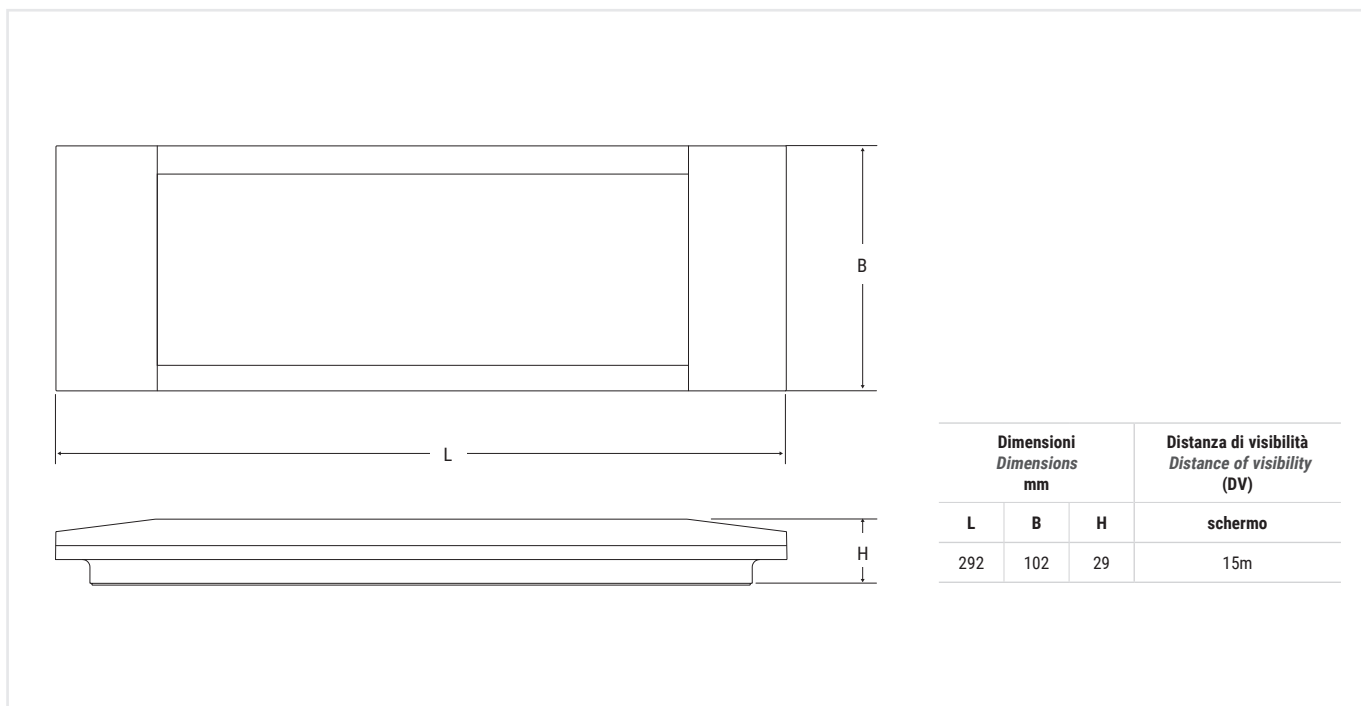
Industrial, service sectors, residential, hospitals, museums, Hotels



Prestazioni secondo EN 1838 / Performance according to EN 1838

Altezza apparecchio Height 	Interasse fra gli apparecchi Centre distance VIE DI ESODO - ESCAPE ROUTES 		Area illuminata da ogni apparecchio Illuminated surface area GRANDI AREE / LARGE AREAS 	
	(m)	Parete / Wall (m)	Plafone / Ceiling (m)	Parete / Wall (m)
2.5	8	-	6x8	-
3	-	12	-	9x9
	illuminamento >1lx a pavimento lungo la linea centrale senza riflessioni Emax/Emin <40 <i>lighting >1lx at floor level along the centre line without reflection Emax/Emin <40</i>		illuminamento >0,5lx a pavimento senza riflessioni Emax/Emin <40 <i>lighting >0,5lx at floor level without reflections Emax/Emin <40</i>	

Prestazioni riferite all'apparecchio Cod. 4412 500 lm
Performance with reference to luminaire Cod. 4412 500 lm

Coefficiente di manutenzione 0,8
Maintenance coefficient 0,8

BLU

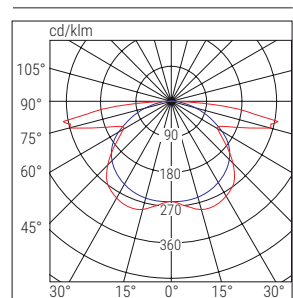

■ C0-C180 ■ C90-C270



ATTIVAZIONE DELLA NOTTURNA BLU:

L'illuminazione blu è attiva fino all'intervento dell'emergenza o all'accensione della luce bianca nella versione SA (se non si imposta la luce blu anche in SA). La disattivazione della luce blu si effettua da Jumper presente sul circuito.

ACTIVATION OF THE BLUE NIGHT LIGHT

The blue lighting work until the intervention of the emergency or the lighting of the white light in the SA version (if the blue light is not set also in SA). The disabling of the blue light is carried out by the Jumper present on the circuit.

	Cod.	W eq.	Descrizione Description	Versione Version	Autonomia Autonomy h	Flusso Flux SE lm	Flusso Flux SA lm	Attivazione lampada notturna / Activation night light	Assorbimento Absorbed Power		Note Notes
									DC	AC	
TR	4410	11	BLU 120 1,5/3h IP42 SE	SE	1.5/3	120/60	-	DA JUMPER	2.5W		
	4411	24	BLU 300 1,5/3h IP42 SE	SE	1.5/3	300/160	-	DA JUMPER	2.5W		
	4412	24GL	BLU 500 1,5/3h IP42 SE	SE	1.5/3	500/250	-	DA JUMPER	2.5W		
	4421	24	BLU 300 1,5/3h IP42 SA/SE	SE/SA	1.5/3	300/160	250	DA JUMPER	3.7W		
	4422	24GL	BLU 500 1,5/3h IP42 SA/SE	SE/SA	1.5/3	500/250	250	DA JUMPER	3.7W		
AT	4430	11	BLU 120 AT IP42 SE	SE	1.5/3	120/60	-	DA JUMPER	2.5W		
	4431	24	BLU 300 AT IP42 SE	SE	1.5/3	300/160	-	DA JUMPER	2.5W		
	4432	24GL	BLU 500 AT IP42 SE	SE	1.5/3	500/250	-	DA JUMPER	2.5W		
	4441	24	BLU 300 AT IP42 SA/SE	SE/SA	1.5/3	300/160	250	DA JUMPER	3.7W		

SEGUE / NEXT >

ACCESSORI - da ordinare separatamente



STAFFA CONTROSOFFITTO
FALSE CEILING BRACKET

Cod. **4266**

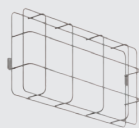

GRIGLIA DI PROTEZIONE
PROTECTIVE GRID

440x215x99 mm

Cod. **3912**



SCATOLA DA INCASSO
RECESSED BOX

Cod. **3733**



SCHERMI SX/DX/BASSO
LH/RH/DOWN SCREENS

Serigrafia su policarbonato opale
Screen print on opal polycarbonate

Cod. **4269**



MODULO RM / RM MODULE

Rest Mode

TR

AT

Cod. **15048**



ADESIVI SX/DX/BASSO
LH/RH/DOWN STICKERS

In dotazione nelle versioni SA
Included in the SA versions

Cod. **4278**



KIT ACCESSORI IP65 / IP65 ACCESSORY KIT

Passacavo, 2 tappi, guarnizione perimetrale. Necessario solo per IP65 nelle versioni 824 / *Cable gland, 2 caps, perimeter gasket. Only necessary for IP65 in the 824 versions*

Cod. **4318**



TELECOMANDO INIBIT RM
RM INIBIT REMOTE CONTROL

Cod. **2730**

RM



061 apparecchi / luminaires

Completa

emergenza / emergency



Caratteristiche

Installazioni Parete, soffitto, incasso, controsoffitto, segnaletica a bandiera e a parete

Corpo Policarbonato, bianco RAL 9003

Ottica Simmetrica, bianca

Schermo Policarbonato trasparente

Conformità EN 60598-1, EN 60598-2-2, EN 60598-2-22, UNI EN 1838, UNI 11222, EN 62034

Applicazioni

Industriale, terziario, civile.

Characteristics

Mounting: Wall, ceiling, recessed, false ceiling, edge mounting and wall signage

Housing Polycarbonate, white RAL 9003

Optics Symmetrical, white

Screen Clear polycarbonate

Compliance EN 60598-1, EN 60598-2-2, EN 60598-2-22, UNI EN 1838, UNI 11222, EN 62034

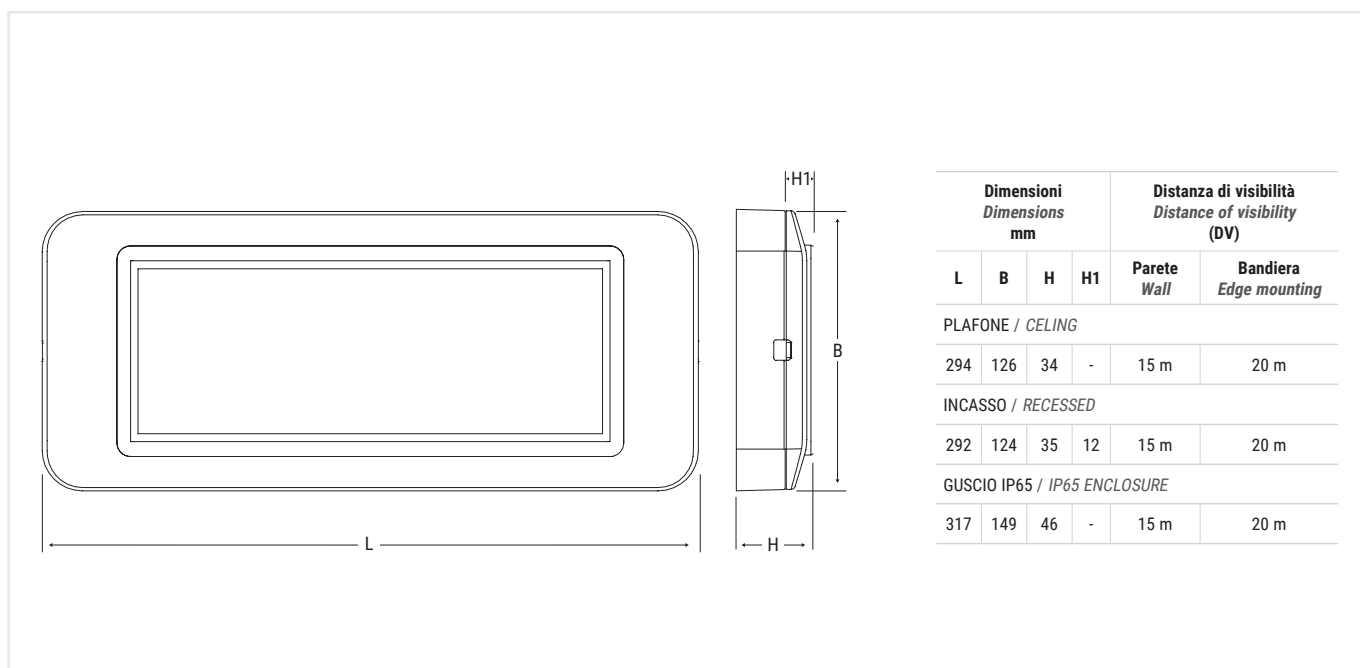

Applications

Industry, service sectors



062

Prestazioni secondo EN 1838 / Performance according to EN 1838





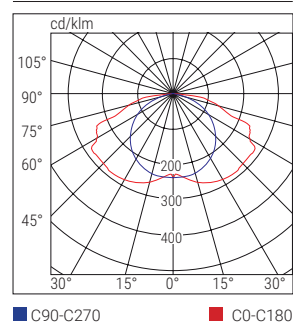

Altezza apparecchio Height 	Interasse fra gli apparecchi Centre distance VIE DI ESODO - ESCAPE ROUTES 		Area illuminata da ogni apparecchio Illuminated surface area GRANDI AREE / LARGE AREAS 	
	(m)	Parete / Wall (m)	Plafone / Ceiling (m)	Parete / Wall (m)
2.5	6	-	4x6	-
3	-	11	-	8x8
illuminamento >1lx a pavimento lungo la linea centrale senza riflessioni Emax/Emin <40 lighting >1lx at floor level along the centre line without reflection Emax/Emin <40			illuminamento >0,5lx a pavimento senza riflessioni Emax/Emin <40 lighting >0,5lx at floor level without reflections Emax/Emin <40	

COMPLETA



Prestazioni riferite all'apparecchio Cod. 4102N 200 lm
Performance with reference to luminaire Cod. 4102N 200 lm

Coefficiente di manutenzione 0,8
Maintenance coefficient 0,8

	Cod.	W eq.	Descrizione Description	Versione Version	Autonomia Autonomy h	Flusso Flux SE lm	Flusso Flux SA lm	Assorbimento Absorbed Power		Note Notes
								DC	AC	
TR	4101N	8	COMPLETA LED 8W SE 1/3	SE	1/3	150/70	-	2.6W		
	4102N	11	COMPLETA LED 11W SE 1/3	SE	1/3	200/80	-	2.6W		
	4103N	24	COMPLETA LED 24W SE 1/3	SE	1/3	500/180	-	2.6W		
	4105N	24	COMPLETA LED 24W SA 1/3	SE/SA	1/3	500/180	240	3.9W		
	4108N	36	COMPLETA LED 36W SE 1/3	SE	1/3	700/240	-	2.6W		
	4110N	36	COMPLETA LED 36W SA 1/3	SE/SA	1/3	700/240	240	3.9W		
AT	4210	8	COMPLETA LED 8W AT SE	SE	1/1.5/2/3/8	200/140/110/80/35	-	1.9W		
	4211	24	COMPLETA LED 24W AT SE	SE	1/1.5/2/3/8	450/300/230/160/70	-	1.9W		
	4213	24	COMPLETA LED 24W AT SA	SE/SA	1/1.5/2/3/8	450/300/230/160/70	250	4W		
	4212	36	COMPLETA LED 36W AT SE	SE	1/1.5/2/3/8	700/470/360/250/100	-	1.9W		
	4214	36	COMPLETA LED 36W AT SA	SE/SA	1/1.5/2/3/8	700/470/360/250/100	250	1.9W		
CT	4200	8	COMPLETA LED 8W CT SE	SE	1/1.5/2/3/8	150/100/75/55/25	-	1.9W		
	4201	11	COMPLETA LED 11W CT SE	SE	1/1.5/2/3/8	250/170/130/85/35	-	1.9W		
	4202	24	COMPLETA LED 24W CT SE	SE	1/1.5/2/3/8	450/305/230/156/65	-	1.9W		
	4203	11	COMPLETA LED 11W CT SA	SE/SA	1/1.5/2/3/8	250/170/130/85/35	250	4W		
	4204	24	COMPLETA LED 24W CT SA	SE/SA	1/1.5/2/3/8	450/305/230/156/65	250	4W		
	4205	36	COMPLETA LED 36W CT SE	SE	1/1.5/2/3/8	700/470/360/250/100	-	1.9W		
	4206	36	COMPLETA LED 36W CT SA	SE/SA	1/1.5/2/3/8	700/470/360/250/100	250	4W		
<p>Gli apparecchi CT possono integrare dispositivi opzionali per l'espansione ad altri sistemi: Modulo LG cod.15036 - Modulo LGFM Cod.15037 - Modulo DALI cod.15038 The CT luminaires can integrate optional devices for expansion to other systems: LG Module cod.15036 - LGFM Module cod.15037 - DALI Module cod.15038</p>										

Completa

ACCESSORI - in dotazione / ACCESSORIES - included



**ADESIVI SX/DX/BASSO
LH/RH/DOWN STICKERS**

Cod. **4278**



**SCATOLA DA INCASSO
RECESSED BOX**

Cod. **3733**

ACCESSORI - da ordinare separatamente / ACCESSORIES - to be ordered separately



KIT GUSCIO IP66 - IK09

Per ottenere una resistenza meccanica fino a 5 volte maggiore, rispetto agli apparecchi tradizionali (IK07)

Cod. **4112**

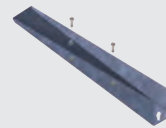

**STAFFA PARETE X BANDIERA
WALL BRACKET X EDGE MOUNTING**

Cod. **4265**

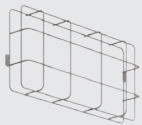

**GRIGLIA DI PROTEZIONE
PROTECTIVE GRID**

Dimensioni / Dimensions 440x215x98,7 mm

Cod. **3912**



**STAFFA CONTROSOFFITTO
FALSE CEILING BRACKET**

Cod. **4266**



MODULO / MODULE LG - LGFM - DALI

Solo per apparecchi CT / CT version only

LG - Cod. 15036

LGFM - Cod. 15037

DALI - Cod. 15038

LG

LGFM

DALI



**SCHERMO BANDIERA BASSO
DOWN EDGE MOUNTED SCREEN**

Serigrafia su policarbonato trasparente
Screen print on clear polycarbonate

Cod. **4268**



MODULO RM / RM MODULE

Rest Mode

Cod. **15048**

TR

AT



**SCHERMI BANDIERA SX/DX
LH/RH EDGE MOUNTED SCREENS**

Serigrafia su policarbonato trasparente
Screen print on clear polycarbonate

Cod. **4267**



**TELECOMANDO INIBIT RM
RM INIBIT REMOTE CONTROL**

Solo apparecchi TR e AT equipaggiati di modulo RM
Only TR and AT devices equipped with RM module

Cod. **2730**

RM



**SCHERMI SX/DX/BASSO
LH/RH/DOWN SCREENS**

Serigrafia su policarbonato opale
Screen print on opal polycarbonate

Cod. **4269**



065 apparecchi / luminaires



WEB
CATALOGUE



Vers. 824

IP65

IP42

IK07

850°



+40°C
0°C

Caratteristiche

Installazioni parete, plafone, binario trifase

Corpo Policarbonato, bianco RAL 9003

Ottica Lenti in policarbonato

Schermo Policarbonato trasparente
Conformità EN 60598-1, EN 60598-2-22, UNI EN 1838, UNI 11222, EN 62034

Applicazioni

Industriale, terziario, ospedali, scuole, civile

Characteristics

Mounting Wall, ceiling, three-phase track

Housing Polycarbonate, white RAL 9003

Optics Clear polycarbonate lenses

Screen Clear polycarbonate

Compliance EN 60598-1, EN 60598-2-22, UNI EN 1838, UNI 11222, EN 62034

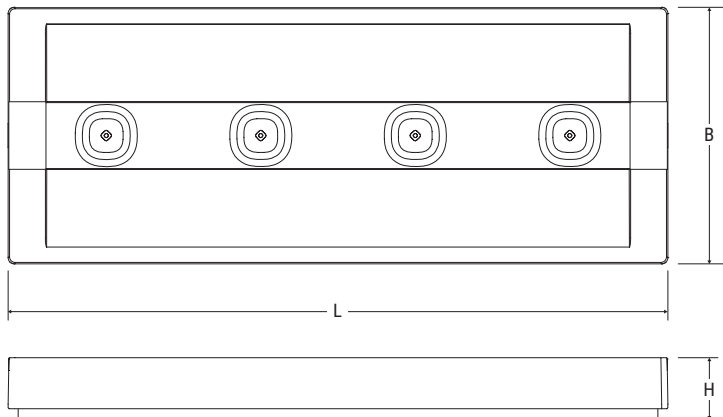

Applications

Industry, service sectors, hospitals, schools, residential



Dimensioni Dimensions mm			Distanza di visibilità Distance of visibility (DV)
L	B	H	
213	83	20	20m

Prestazioni secondo EN 1838 / Performance according to EN 1838

Altezza apparecchio Height 	Interasse fra gli apparecchi Centre distance VIE DI ESODO - ESCAPE ROUTES 		Area illuminata da ogni apparecchio Illuminated surface area GRANDI AREE / LARGE AREAS 	
	(m)	Parete / Wall (m)	Plafone / Ceiling (m)	Parete / Wall (m)
2.5	8	-	5x6	-
3	-	15	-	14x14

illuminamento >1lx a pavimento lungo la linea centrale senza riflessioni Emax/Emin <40 <i>lighting >1lx at floor level along the centre line without reflection Emax/Emin <40</i>	illuminamento >0,5lx a pavimento senza riflessioni Emax/Emin <40 <i>lighting >0,5lx at floor level without reflections Emax/Emin <40</i>
--	---

Prestazioni riferite all'apparecchio Cod. 4304 500 lm
Performance with reference to luminaire Cod. 4304 500 lm

Coefficiente di manutenzione 0,8
Maintenance coefficient 0,8

UP LED

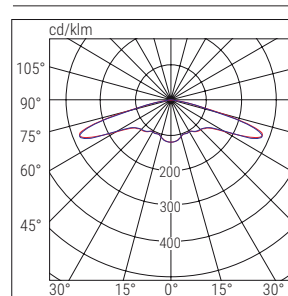



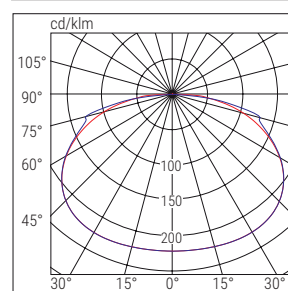

■ C90-C270 ■ C0-C180

UP LED 824



■ C0-C180 ■ C90-C270

	Cod.	W eq.	Descrizione Description	Versione Version	Autonomia Autonomy h	Flusso Flux SE lm	Flusso Flux SA lm	Assorbimento Absorbed Power		Note Notes
								DC	AC	
TR	824S	8	UP LED 824S SE TR 3	SE	3	100			1 W	IP42
	824M	11	UP LED 824M SE TR 1.5	SE	1.5	160			1 W	IP42
	824L	24	UP LED 824L SE TR 1.5	SE	1.5	300			1 W	IP42
	824MSA	11	UP LED 824M SA TR 1.5	SE/SA	1.5	160	100		2.3 W	IP42
	824LSA	24	UP LED 824L SA TR 1.5	SE/SA	1.5	300	100		2.3 W	IP42
	824XLSA	24GL	UP LED 824XL SA TR 1	SE/SA	1	500	100		2.3 W	IP42
	4300	6-8	UP LED 6-8W SE 1.5/3 IP65	SE	1.5/3	250/130			1 W	
	4301	11-24	UP LED 11-24W SE 1.5/3 IP65	SE	1.5/3	300/160			1 W	
	4302	24-36	UP LED 24-36W SE 1/3 IP65	SE	1/3	500/250			1 W	
	4303	11-24	UP LED 11-24W SA 1.5/3 IP65	SE/SA	1.5/3	300/160	180		2.3 W	
4304	24-36	UP LED 24-36W SA 1/3 IP65	SE/SA	1/3	500/250	240		2.3 W		
AT	4374	11-24	UPLD 1124W IP65 AT SE	SE	1/1.5/2/3/8	300/230/170/120/50			1.6 W	
	4375	24-36	UPLD 2436W IP65 AT SE	SE	1/1.5/2/3/8	500/350/250/180/80			1.6 W	
	4376	11-24	UPLD 1124W IP65 AT SA	SE/SA	1/1.5/2/3/8	300/230/170/120/50	110		2.9 W	
	4377	24-36	UPLD 2436W IP65 AT SA	SE/SA	1/1.5/2/3/8	500/350/250/180/80	200		2.9 W	
CT	4370	11-24	UPLD 1124W IP65 CT SE	SE	1/1.5/ 2/3/8	300/230/170/120/50			1.6 W	
	4371	24-36	UPLD 2436W IP65 CT SE	SE	1/1.5/ 2/3/8	500/350/250/180/80			1.6 W	
	4372	11-24	UPLD 1124W IP65 CT SA	SE/SA	1/1.5/ 2/3/8	300/230/170/120/50	110		2.9 W	
	4373	24-36	UPLD 2436W IP65 CT SA	SE/SA	1/1.5/ 2/3/8	500/350/250/180/80	200		2.9 W	

Gli apparecchi CT possono integrare dispositivi opzionali per l'espansione ad altri sistemi: Modulo LG cod.15036 - Modulo LGFM Cod.15037 - Modulo DALI cod.15038
The CT luminaires can integrate optional devices for expansion to other systems: LG Module cod.15036 - LGFM Module cod.15037 - DALI Module cod.15038

SEGUE / NEXT >

ACCESSORI - in dotazione / ACCESSORIES - included



KIT ACCESSORI IP65 / IP65 ACCESSORY KIT
 Passacavo, 2 tappi, guarnizione perimetrale
 Escluso versione 824 / Cable gland, 2 caps, perimeter seal Excluding version 824
 Cod. **4318**

ACCESSORI - da ordinare separatamente / ACCESSORIES - to be ordered separately



**SCHERMO BANDIERA
EDGE MOUNTED SCREEN**
 Cod. **4325**



KIT ACCESSORI IP65 / IP65 ACCESSORY KIT
 Passacavo, 2 tappi, guarnizione perimetrale. Necessario solo per IP65 nelle versioni 824 / Cable gland, 2 caps, perimeter gasket. Only necessary for IP65 in the 824 versions
 Cod. **4318**



MODULO / MODULE LG - LGFM - DALI
 Solo per apparecchi CT / CT version only

LG - Cod. **15036**
LGFM - Cod. **15037**
DALI - Cod. **15038**

LG
LGFM
DALI



**GRIGLIA DI PROTEZIONE
EM PROTECTIVE GRID**
 305x135x80 mm
 Cod. **18591**



MODULO RM / RM MODULE
 Rest Mode

TR
AT

Cod. **15048**



**KIT BINARIO TRIFASE
THREE-PHASE TRACK KIT**
 Cod. **4319**



**TELECOMANDO INIBIT RM
RM INIBIT REMOTE CONTROL**
 Solo apparecchi TR e AT equipaggiati di modulo RM
 Only TR and AT devices equipped with RM module
 Cod. **2730**

RM



**SCHERMI SX/DX/BASSO/ALTO
LH/RH/DOWN/UP SCREENS**
 Etichetta su policarbonato opale
 Label on opal polycarbonate
 Cod. **4326**



069 apparecchi / luminaires

Pratica IP65

emergenza / emergency



IP65

IK08

850°



+40°C
0°C

Caratteristiche

Installazioni Incasso, parete, soffitto, bandiera, sospensione, barra elettrificata

Corpo Policarbonato, bianco RAL 9003

Ottica Lente in PMMA a tecnologia RTI (Riflessione Totale Interna)

Schermo Policarbonato bianco RAL 9003

Conformità EN 60598-1, EN 60598-2-2, EN 60598-2-22, UNI EN 1838, UNI 11222, EN 62034.

Applicazioni

Industriale, Outdoor, Terziario

Characteristics

Mounting Recessed, wall, ceiling, edge mounting, suspended, electrified track

Housing Polycarbonate, white RAL 9003

Optics PMMA lens with RTI technology (Total Internal Reflection)

Housing Polycarbonate, white RAL 9003

Compliance EN 60598-1, EN 60598-2-2, EN 60598-2-22, UNI EN 1838, UNI 11222, EN 62034.

Applications

Industry, outdoors, service sectors

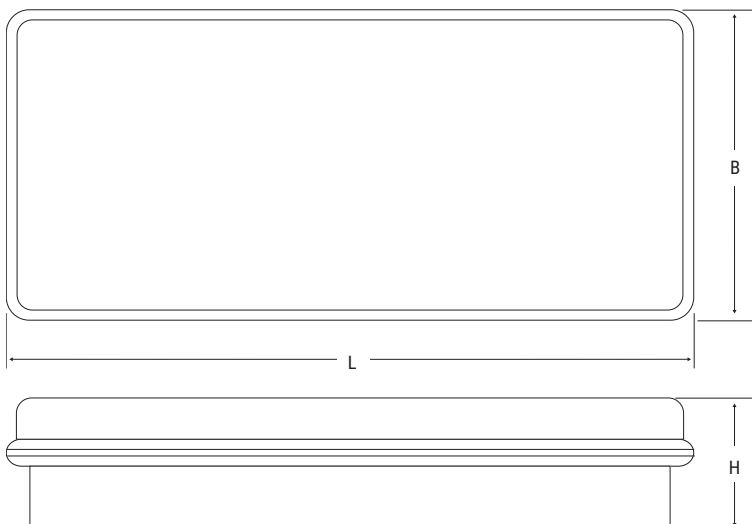

Dimensioni Dimensions mm			Distanza di visibilità Distance of visibility (DV)
L	B	H	
300	138	55	25 m

070

Prestazioni secondo EN 1838 / Performance according to EN 1838

Altezza apparecchio Height	Interasse fra gli apparecchi Centre distance VIE DI ESODO - ESCAPE ROUTES		Area illuminata da ogni apparecchio Illuminated surface area GRANDI AREE / LARGE AREAS	
	(m)	Parete / Wall (m)	Parete / Wall (m)	Plafone / Ceiling (m)
2.5	8	-	4x6	-
3	-	9	-	6x7

illuminamento >1lx a pavimento lungo la linea centrale senza riflessioni Emax/Emin <40
lighting >1lx at floor level along the centre line without reflection Emax/Emin <40

illuminamento >0,5lx a pavimento senza riflessioni Emax/Emin <40
lighting >0,5lx at floor level without reflections Emax/Emin <40

PRATICA IP65

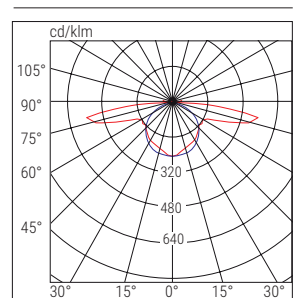

■ C90-C270 ■ C0-C180

Prestazioni riferite all'apparecchio Cod. 250SE 300 lm
Performance with reference to luminaire Cod. 250SE 300 lm

Coefficiente di manutenzione 0,8
Maintenance coefficient 0,8

	Cod.	W eq.	Descrizione Description	Versione Version	Autonomia Autonomy h	Flusso Flux SE lm	Flusso Flux SA lm	Assorbimento Absorbed Power		Note Notes
								DC	AC	
TR	250SE	24	PRATICA IP65 300L 1.5/3 SE TR	SE	1.5/3	300/160	-		3 W	
	250SA	24	PRATICA IP65 300L 1.5/3 SA TR	SE/SA	1.5/3	300/160	200		5.1 W	
	500SE	24GL	PRATICA IP65 500L 1.5/3 SE TR	SE	1.5/3	500/250	-		3 W	
	500SA	24GL	PRATICA IP65 500L 1.5/3 SA TR	SE/SA	1.5/3	500/250	200		5.1 W	
AT	250ATSE	24	PRATICA IP65 300L SE AT	SE	1/1.5/2/3/8	300/300/250/160/70	-		2.6 W	
	250ATSA	24	PRATICA IP65 300L SA AT	SE/SA	1/1.5/2/3/8	300/300/250/160/70	200		4.8 W	
	500ATSE	24GL	PRATICA IP65 500L SE AT	SE	1/1.5/2/3/8	500/500/350/250/100	-		2.6 W	
	500ATSA	24GL	PRATICA IP65 500L SA AT	SE/SA	1/1.5/2/3/8	500/500/350/250/100	200		4.8 W	

A 3 Ingressi $\varnothing 16\div 20$ mm e accessori per mantenere il grado IP65 / 3 Inputs $\varnothing 16\div 20$ mm and accessories to maintain the IP65 protection rating

B Ingresso posteriore idoneo per scatola 503 o corrugato in parete / Rear inlet suitable for box 503 or corrugated wall box

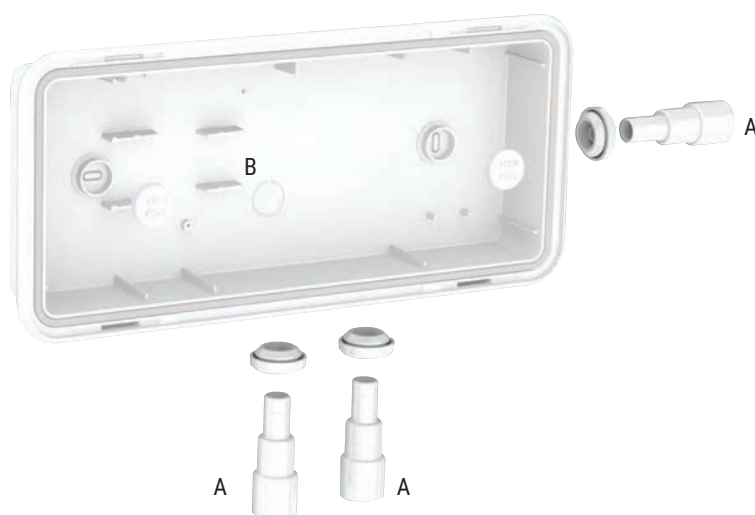

ACCESSORI - in dotazione / ACCESSORIES - included



ADATTATORE TUBO 16/20mm BIANCO
2 MEMBRANA PRESSACAVO IP65
CONDUIT ADAPTER 16/20 mm WHITE
2 CABLE GLAND MEMBRANES IP65
Installazione con tubo $\varnothing 16$ o $\varnothing 20$ mm / Mounting with a $\varnothing 16$ or $\varnothing 20$ mm conduit



ADESIVI SX/DX/BASSO/ALTO
LH/RH/DOWN/UP STICKERS
Solo per versioni SA / SA versions only

Cod. 4117

Pratica IP65

emergenza / emergency

ACCESSORI - da ordinare separatamente / **ACCESSORIES** - to be ordered separately



GANCI PER SOSPENSIONE
SUSPENDED MOUNTING HOOKS

Cod. 3723



SCATOLA DA INCASSO
RECESSED BOX

Cod. 2742

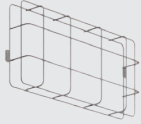

GRIGLIA DI PROTEZIONE
PROTECTIVE GRID

440x215x99 mm

Cod. 3912

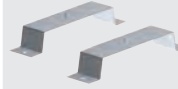

STAFFA CONTROSOFFITTO
FALSE CEILING BRACKET

Cod. 2751



MODULO RM
RM MODULE

Rest Mode

Cod. 15048

TR

AT



SCHERMI
SCREENS

Cod. 4124 SX-DX / LH/RH

Cod. 4125 BASSO / DOWN

Cod. 4126 ALTO / UP



TELECOMANDO INIBIT RM
RM INIBIT REMOTE CONTROL

Solo apparecchi TR e AT equipaggiati di modulo RM
Only TR and AT devices equipped with RM module

Cod. 2730

RM



ADESIVI SX/DX/BASSO/ALTO
LH/RH/DOWN/UP STICKERS

Cod. 4117



073 apparecchi / luminaires

Pratica SanificaAria

emergenza / emergency



WEB
CATALOGUE



IP20

IK08

850°



8-12-24h



+40°C
0°C

Caratteristiche emergenza

Installazioni Parete, soffitto, sospensione, bandiera, barra elettrificata

Corpo ABS, bianco RAL 9003

Ottica Antiabbagliamento in PMMA

Schermo Policarbonato trasparente

Conformità EN60598-1, EN60598-2-22, EN60335-2-65, ISO 15714, 2014/30/UE, 2014/35/UE

Applicazioni

Industriale, Terziario

Emergency features

Mounting Wall, ceiling, suspended, edge mounting, electrified track

Housing ABS, white RAL 9003

Optics PMMA anti-glare diffuser

Screen Clear polycarbonate

Compliance EN60598-1, EN60598-2-22, EN60335-2-65, ISO 15714, 2014/30/EU, 2014/35/EU

Applications

Industry, service sectors

Caratteristiche del sanificatore

Specifications of the Air Purifier

Input power uvOxy® 10 W

UV-C wavelength 254nm

Sanitisation flow rate 5 m³/h

UV-C power 7W

UV-C radiation power 2.5W

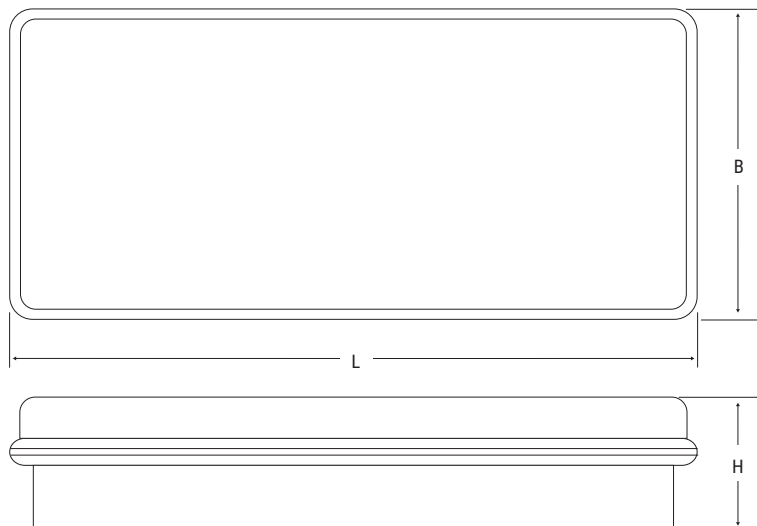

ESEMPIO DI SANIFICAZIONE INIZIALE EXAMPLE OF INITIAL SANITISATION

Dimensioni ambiente / Room size		
m ³	m ²	h
10	4	2
25	10	5
50	20	10
75	30	15
100	40	20

Dimensioni Dimensions mm			Distanza di visibilità Distance of visibility (DV)
L	B	H	
300	138	55	25 m

Prestazioni secondo EN 1838 / Performance according to EN 1838

PRATICA SanificaAria

NORMA UNI EN 1838	Altezza apparecchio Height	Interasse fra gli apparecchi Centre distance VIE DI ESODO - ESCAPE ROUTES		Area illuminata da ogni apparecchio Illuminated surface area GRANDI AREE / LARGE AREAS	
	(m)	Parete / Wall (m)	Plafone / Ceiling (m)	Parete / Wall (m)	Plafone / Ceiling (m)
	2.5	8	-	4x6	-
	3	-	9	-	6x7
	illuminamento >1lx a pavimento lungo la linea centrale senza riflessioni Emax/Emin <40 lighting >1lx at floor level along the centre line without reflection Emax/Emin <40		illuminamento >0,5lx a pavimento senza riflessioni Emax/Emin <40 lighting >0,5lx at floor level without reflections Emax/Emin <40		

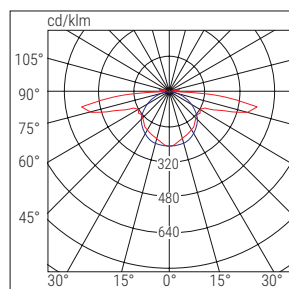

■ C90-C270 ■ C0-C180

	Portata fino a Flow rate up to 5 m³/h	Tempo di sanificazione iniziale Initial sanitisation time 6h	Tempo di sanificazione iniziale Initial sanitisation time 12h
--	---	--	---

Prestazioni riferite al modello 250SEUV 300lm installato a parete / Performance with reference to luminaire 250SEUV 300lm

	Cod.	W eq.	Descrizione Description	Versione Version	Autonomia Autonomy h	Flusso Flux SE lm	Flusso Flux SA lm	Flusso di Sanificazione Sanitisation flow rate m³/h			Assorbimento Absorbed Power W	
								1	2	3		
TR	250SAUV	24	PRATICA 300L 1.5/3h SATR UVOXY	SE/SA	1.5/3	300/160	200	5	-	-	4	10
	250SEUV	24	PRATICA 300L 1.5/3h SETR UVOXY	SE	1.5/3	300/160	-	5	-	-	4	10
	500SAUV	24GL	PRATICA 500L 1.5/3h SATR UVOXY	SE/SA	1.5/3	500/250	200	5	-	-	4	10
	500SEUV	24GL	PRATICA 500L 1.5/3h SETR UVOXY	SE	1.5/3	500/250	-	5	-	-	4	10
AT	250ATSAUV	24	PRATICA 300L SA AT UVOXY	SE/SA	1/1.5/2/3/8	300/300/250/160/70	200	5	-	-	4	10
	250ATSEUV	24	PRATICA 300L SE AT UVOXY	SE	1/1.5/2/3/8	300/300/250/160/70	-	5	-	-	4	10
	500ATSAUV	24GL	PRATICA 500L SA AT UVOXY	SE/SA	1/1.5/2/3/8	500/500/350/250/100	200	5	-	-	4	10
	500ATSEUV	24GL	PRATICA 500L SE AT UVOXY	SE	1/1.5/2/3/8	500/500/350/250/100	-	5	-	-	4	10

ACCESSORI - in dotazione / ACCESSORIES - included

ADATTATORE TUBO 16/20mm BIANCO
Installazione con tubo Ø 16 o Ø 20 mm

ACCESSORI - da ordinare separatamente / ACCESSORIES - to be ordered separately

RICAMBIO CARTUCCIA SANIFICANTE uvOxy®
SPARE PART PURIFICATION CARTRIDGE
Durata 12 mesi, con utilizzo continuo 24h/giorno
Duration 12 months, at a continuous use 24h/day
Cod. 26723

ADESIVI SX/DX/BASSO/ALTO
LH/RH/DOWN/UP STICKERS
Solo per versioni SA
SA versions only
Cod. 4117

SCHERMI
SCREENS
Cod. 4124 SX-DX / LH-RH
Cod. 4125 BASSO / DOWN
Cod. 4126 ALTO / UP

GANCI PER SOSPENSIONE
SUSPENDED MOUNTING HOOKS
Cod. 3723

GRIGLIA DI PROTEZIONE
PROTECTIVE GRID
440x215x99 mm
Cod. 3912

TELECOMANDO INIBIT RM
RM INIBIT REMOTE CONTROL
Solo apparecchi TR e AT equipaggiati di modulo RM
Only TR and AT devices equipped with RM module
Cod. 2730

Pratica IP42

emergenza / emergency



IP42

IK07

850°



+40°C
0°C

Caratteristiche

Installazioni Parete, soffitto, incasso, sospensione, su barra elettrificata

Corpo Policarbonato bianco, RAL 9003

Schermo Policarbonato trasparente

Conformità EN 60598-1, EN 60598-2-2, EN 60598-2-22, UNI EN 1838, UNI 11222, EN 62034

Applicazioni

Terziario, attività commerciali, negozi, ristoranti, uffici

Characteristics

Mounting Wall, ceiling, recessed, suspended, electrified track

Housing Polycarbonate, white RAL 9003

Screen Clear polycarbonate

Compliance EN 60598-1, EN 60598-2-2, EN 60598-2-22, UNI EN 1838, UNI 11222, EN 62034

Applications

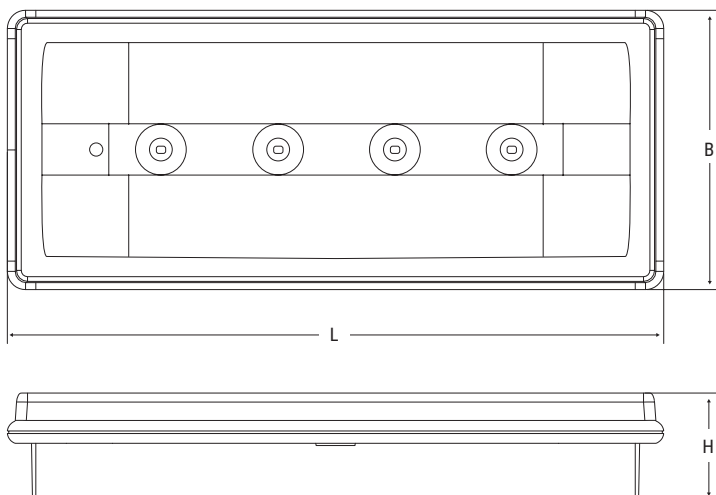

Service sectors, commercial activities, shops, restaurants, offices



Dimensioni Dimensions mm			Distanza di visibilità Distance of visibility (DV)
L	B	H	
280	119	46	21 m

076

Prestazioni secondo EN 1838 / Performance according to EN 1838

Altezza apparecchio Height 	Interasse fra gli apparecchi Centre distance VIE DI ESODO - ESCAPE ROUTES 		Area illuminata da ogni apparecchio Illuminated surface area GRANDI AREE / LARGE AREAS 	
	(m)	Parete / Wall (m)	Plafone / Ceiling (m)	Parete / Wall (m)
2.5	5	-	3x3	-
3	-	8	-	6x6

illuminamento >1lx a pavimento lungo la linea centrale senza riflessioni Emax/Emin <40
lighting >1lx at floor level along the centre line without reflection Emax/Emin <40

illuminamento >0,5lx a pavimento senza riflessioni Emax/Emin <40
lighting >0,5lx at floor level without reflections Emax/Emin <40

PRATICA IP42

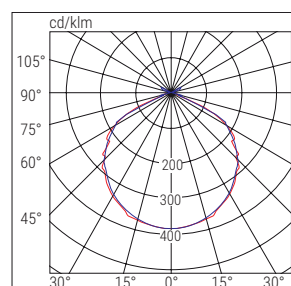

■ C0-C180 ■ C90-C270

Prestazioni riferite all'apparecchio Cod. 4400 200 lm
Performance with reference to luminaire Cod. 4400 200 lm

Coefficiente di manutenzione 0,8
Maintenance coefficient 0,8

	Cod.	W eq.	Descrizione Description	Versione Version	Autonomia Autonomy h	Flusso Flux SE lm	Flusso Flux SA lm	Assorbimento Absorbed Power		Note Notes
								DC	AC	
TR	4400	11	PRATICA IP42 200L 1/1.5/3 SATR	SE/SA	1/1.5/3	200/160/100	180		1.4 W	
	4401	24	PRATICA IP42 300L 1.5/3 SATR	SE/SA	1.5/3	300/160	180		2.5 W	
	4402	24GL	PRATICA IP42 500L 1.5/3 SATR	SE/SA	1.5/3	500/250	180		2.5 W	
AT	4403	11	PRATICA IP42 200L SA AT	SE/SA	1/1.5/2/3/8	200/160/130/100/30	180		1.4 W	
	4404	24	PRATICA IP42 300L SA AT	SE/SA	1/1.5/2/3/8	300/300/250/160/70	180		4.8 W	
	4405	24GL	PRATICA IP42 500L SA AT	SE/SA	1/1.5/2/3/8	500/500/350/250/100	180		4.8 W	

ACCESSORI - in dotazione / ACCESSORIES - included



Pratica IP42

emergenza / emergency

ACCESSORI - da ordinare separatamente / **ACCESSORIES** - to be ordered separately



PRESSATUBO PG16/PG20
CABLE CONDUIT GLAND PG16/PG20

Cod. 3727



STAFFE CONTROSOFFITTO
FALSE CEILING BRACKETS

Cod. 2751



MODULO RM
RM MODULE
Rest Mode

Cod. 15048

TR

AT



GANCI PER SOSPENSIONE
SUSPENDED MOUNTING HOOKS

Cod. 3723



TELECOMANDO INIBIT RM
RM INIBIT REMOTE CONTROL

Solo apparecchi TR e AT equipaggiati di modulo RM
Only TR and AT devices equipped with RM module

Cod. 2730

RM

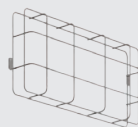

GRIGLIA DI PROTEZIONE
PROTECTIVE GRID

440x215x99 mm

Cod. 3912



SCHERMI
SCREENS

Cod. 4127 SX-DX / LH/RH

Cod. 4128 BASSO / DOWN

Cod. 4129 ALTO / UP



079 apparecchi / luminaires

Ticinque

emergenza / emergency



IP65

IP42

IK07

850°



+40°C
0°C

Caratteristiche

Installazioni Parete, soffitto

Corpo Policarbonato bianco RAL 9003

Ottica Simmetrica, bianca

Schermo Policarbonato trasparente

Conformità EN 60598-1, EN 60598-2-22,
UNI EN 1838, UNI 11222, EN 62034

Applicazioni

Industriale, terziario, centri commerciali

Characteristics

Mounting Wall, ceiling

Housing Polycarbonate, white RAL 9003

Optics Symmetrical, white

Screen Clear polycarbonate

Compliance EN 60598-1, EN 60598-2-22,
UNI EN 1838, UNI 11222, EN 62034

Applications

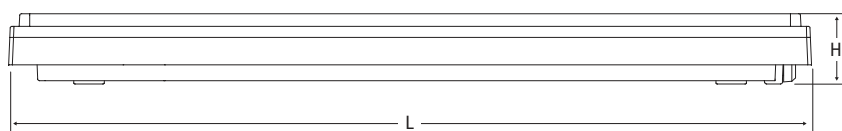
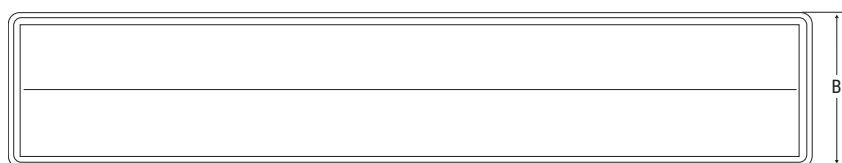

Industry, service sectors, shopping centres



Dimensioni Dimensions mm			Distanza di visibilità Distance of visibility (DV)
L	B	H	
549	147	43	28 m

080

Prestazioni secondo EN 1838 / Performance according to EN 1838

Altezza apparecchio Height 	Interasse fra gli apparecchi Centre distance VIE DI ESODO - ESCAPE ROUTES 		Area illuminata da ogni apparecchio Illuminated surface area GRANDI AREE / LARGE AREAS 	
	(m)	Parete / Wall (m)	Plafone / Ceiling (m)	Parete / Wall (m)
2.5	8	-	8x8	-
3	-	16	-	11x11
7	-	22	-	14x14

illuminamento >1lx a pavimento lungo la linea centrale senza riflessioni Emax/Emin <40 <i>lighting >1lx at floor level along the centre line without reflection Emax/Emin <40</i>	illuminamento >0,5lx a pavimento senza riflessioni Emax/Emin <40 <i>lighting >0,5lx at floor level without reflections Emax/Emin <40</i>
--	---

TICINQUE

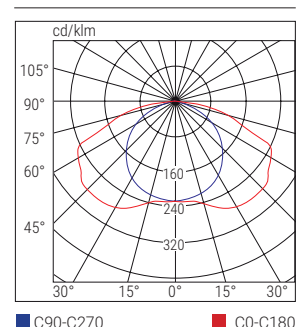

■ C90-C270

■ C0-C180

Prestazioni riferite all'apparecchio Cod. 8590 800 lm
Performance with reference to luminaire Cod. 8590 800 lm

Coefficiente di manutenzione 0,8
Maintenance coefficient 0,8

	Cod.	W eq.	Descrizione Description	Versione Version	Autonomia Autonomy h	Flusso Flux SE lm	BOOSTER BATTERY Flusso / Flux SE lm >50%	Flusso Flux SA lm	Assorbimento Absorbed Power		Note Notes
									DC	AC	
TR	8584	18	TICINQUE IP42 LED 18W SE 6	SE	3/6	400/260				1.7 W	IP42
	8585	18	TICINQUE IP42 LED 18W SA 8	SE/SA	8	260		300		3.8 W	IP42
	8586	18	TICINQUE IP65 LED 18W SE 6	SE	3/6	400/260				1.7 W	IP65
	8587	18	TICINQUE IP65 LED 18W SA 8	SE/SA	8	260		300		3.8 W	IP65
	8590	24	GRANLUCE T5 LED IP65 SE 2	SE	2	800				1.7 W	IP65
	8591	24	GRANLUCE T5 LED IP65 SA 2	SE/SA	2	800		300		3.8 W	IP65
	8597	36	GRANLUCE T5 LED IP65 SE 1	SE	1	1500				1.7 W	IP65
	8598	36	GRANLUCE T5 LED IP65 SA 1	SE/SA	1	1500		300		3.8 W	IP65
AT	8592	36	G.LUCE T5 LED AT AR IP65 SE	SE	1/1.5/2/3/8	1250/1000/800/550/210	RA06 BATTERY			3.4W	IP65
	8593	36	G.LUCE T5 LED AT AR IP65 SA	SE/SA	1/1.5/2/3/8	1250/1000/800/550/210	RA06 BATTERY	500		6.6W	IP65

ACCESSORI - in dotazione / ACCESSORIES - included



3 MEMBRANE PRESSACAVO M16 IP65
3 CABLE GLAND MEMBRANES M16 IP65
Premontate sulle tre uscite (Alto, DX, SX)
Pre-mounted on the three outlets (UP, RH, LH)

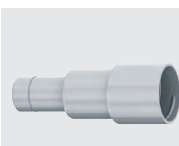

ADATTATORE TUBO 16/20mm BIANCO
CONDUIT ADAPTER 16/20 mm WHITE
Installazione con tubo Ø 16 o Ø 20 mm
Mounting with a Ø16 or Ø20 mm conduit

ACCESSORI - da ordinare separatamente / ACCESSORIES - to be ordered separately



BOOSTER BATTERY

Compatibile con / Compatible with
Cod. 8592 - 8593

Cod. **RA06** - LiFe 9.6V 1.5Ah



ADESIVO DX STICKER RH

Cod. 11584

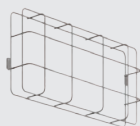

GRIGLIA DI PROTEZIONE PROTECTIVE GRID

685x182x110 mm

Cod. 3905



ADESIVO SX STICKER LH

Cod. 11583



MODULO RM RM MODULE

Rest Mode

Cod. 15048

TR

AT



ADESIVO BASSO STICKER DOWN

Cod. 11585



TELECOMANDO INIBIT RM RM INIBIT REMOTE CONTROL

Solo apparecchi TR e AT equipaggiati di modulo RM
Only TR and AT devices equipped with RM module

Cod. 2730

RM



ADESIVO USCITA STICKER EXIT

Cod. 11582



083 apparecchi / luminaires

Ticinque TuttoLED

emergenza / emergency



IP65

IP42

IK07

850°



+40°C
0°C

Caratteristiche

Installazioni Parete, soffitto

Corpo Policarbonato grigio RAL 7035

Ottica Simmetrica, bianca

Schermo Policarbonato trasparente

Conformità EN 60598-1, EN 60598-2-22,
UNI EN 1838, UNI 11222, EN 62034

Applicazioni

Industriale, Terziario

Characteristics

Mounting Wall, ceiling

Housing Polycarbonate, grey RAL 7035

Optics Symmetrical, white

Screen Clear polycarbonate

Compliance EN 60598-1, EN 60598-2-22,
UNI EN 1838, UNI 11222, EN 62034

Applications

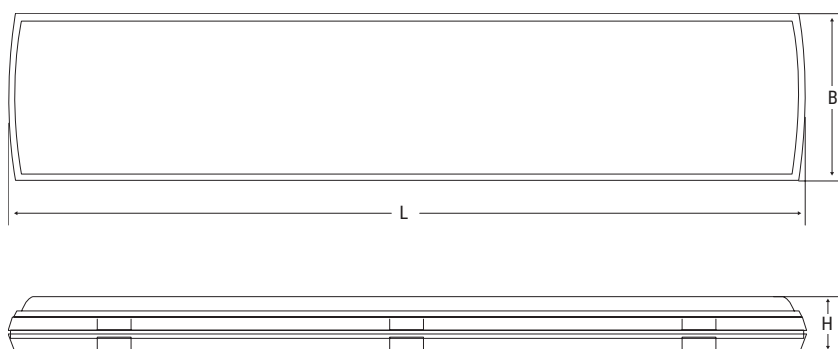

Industry, service sectors



Dimensioni Dimensions mm			Distanza di visibilità Distance of visibility (DV)
L	B	H	
610	128	54	28 m

084

Prestazioni secondo EN 1838 / Performance according to EN 1838

Altezza apparecchio Height 	Interasse fra gli apparecchi Centre distance VIE DI ESODO - ESCAPE ROUTES 		Area illuminata da ogni apparecchio Illuminated surface area GRANDI AREE / LARGE AREAS 	
	(m)	Parete / Wall (m)	Plafone / Ceiling (m)	Parete / Wall (m)
2.5	7	-	6x6	-
3	-	12	-	9x9

illuminamento >1lx a pavimento lungo la linea centrale senza riflessioni Emax/Emin <40 <i>lighting >1lx at floor level along the centre line without reflection Emax/Emin <40</i>	illuminamento >0,5lx a pavimento senza riflessioni Emax/Emin <40 <i>lighting >0,5lx at floor level without reflections Emax/Emin <40</i>
--	---

TICINQUE TUTTOLED

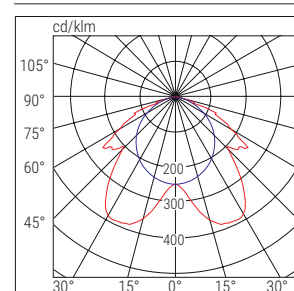

■ C90-C270 ■ C0-C180

Prestazioni riferite all'apparecchio Cod. 8595 400 lm
Performance with reference to luminaire Cod. 8595 400 lm

Coefficiente di manutenzione 0,8
Maintenance coefficient 0,8

	Cod.	W eq.	Descrizione Description	Versione Version	Autonomia Autonomy h	Flusso Flux SE lm	Flusso Flux SA lm	Assorbimento Absorbed Power		Note Notes
								DC	AC	
TR	8594	18	T5 TUTTOLED IP42 18 SE 3/6	SE	3/6	400/260	-		1.7W	IP42
	8596	18	T5 TUTTOLED IP65 18 SA 5	SE/SA	5	400	300		3.8W	IP65
	8595	18	T5 TUTTOLED IP65 18 SE 3/6	SE	3/6	400/260	-		1.7W	IP65

ACCESSORI - in dotazione / ACCESSORIES - included

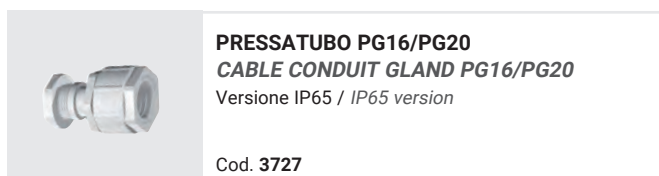

ACCESSORI - da ordinare separatamente / ACCESSORIES - to be ordered separately

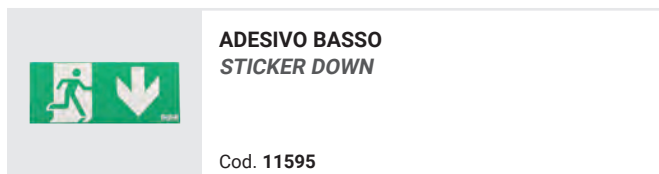
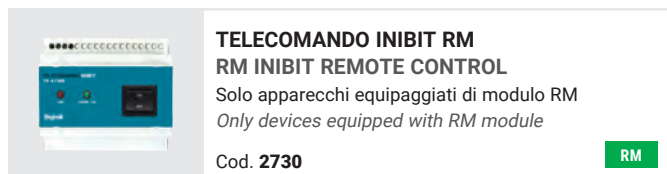
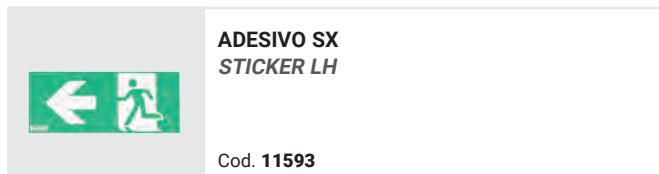
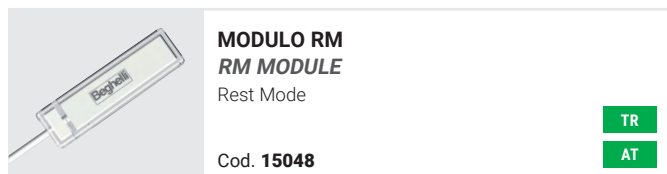
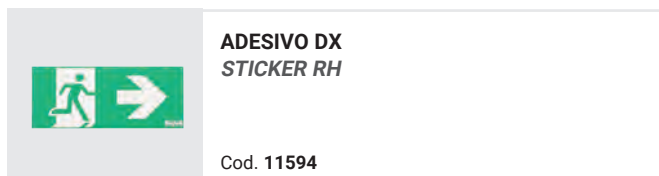

Stile In

emergenza / emergency



WEB
CATALOGUE



IP40

IK05

850°



+40°C
0°C

Caratteristiche

Installazioni Parete, soffitto, incasso, controsoffitto, bandiera

Corpo Policarbonato bianco RAL 9003

Ottica Simmetrica bianca in policarbonato

Schermo Policarbonato trasparente

Conformità EN 60598-1, EN 60598-2-2, EN 60598-2-22, UNI EN 1838, UNI 11222, EN 62034

Applicazioni

Terziario, attività commerciali, negozi, ristoranti, uffici

Characteristics

Mounting Wall, ceiling, recessed, false ceiling, edge mounting

Housing Polycarbonate, white RAL 9003

Optics symmetrical, polycarbonate, white

Screen Clear polycarbonate

Compliance EN 60598-1, EN 60598-2-2, EN 60598-2-22, UNI EN 1838, UNI 11222, EN 62034

Applications

Service sectors, commercial activities, shops, restaurants, offices

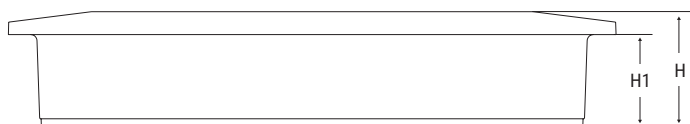
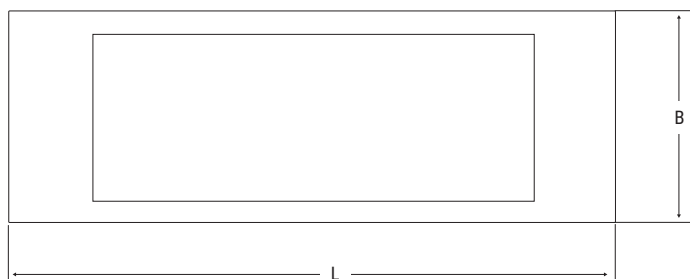

Dimensioni Dimensions mm				Distanza di visibilità Distance of visibility (DV)	
L	B	H	H1	schermo screen	bandiera edge mounting
292	102	55.5	44.5	15m	20m

Prestazioni secondo EN 1838 / Performance according to EN 1838

Altezza apparecchio Height	Interasse fra gli apparecchi Centre distance VIE DI ESODO - ESCAPE ROUTES		Area illuminata da ogni apparecchio Illuminated surface area GRANDI AREE / LARGE AREAS	
	Parete / Wall (m)	Plafone / Ceiling (m)	Parete / Wall (m)	Plafone / Ceiling (m)
(m)				
2.5	5	-	3x3	-
3	-	7	-	5x5
	illuminamento >1lx a pavimento lungo la linea centrale senza riflessioni Emax/Emin <40 lighting >1lx at floor level along the centre line without reflection Emax/Emin <40		illuminamento >0,5lx a pavimento senza riflessioni Emax/Emin <40 lighting >0,5lx at floor level without reflections Emax/Emin <40	

Prestazioni riferite all'apparecchio Cod. 1499L 130 lm
Performance with reference to luminaire Cod. 1499L 130 lm

Coefficiente di manutenzione 0,8
Maintenance coefficient 0,8



VERSIONE / VERSION
Cod. 1499 - 1499/24

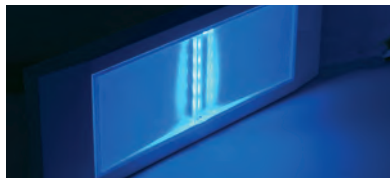

STILE IN BLU TR - Cod. 1499BLU

Apparecchio di emergenza con possibilità di attivazione della funzione luce notturna blu
Emergency luminaire with possibility of activating the blue night light function

STILE IN 1499, 1499-24

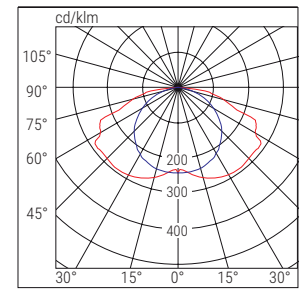

■ C90-C270 ■ C0-C180

STILE IN 1499L, 1499BLU

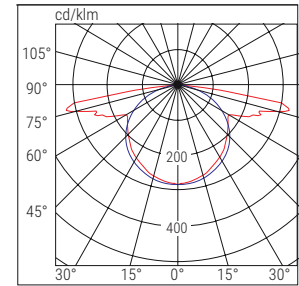

■ C90-C270 ■ C0-C180

	Cod.	W eq.	Descrizione Description	Versione Version	Autonomia Autonomy h	Flusso Flux SE lm	Flusso Flux SA lm	Assorbimento Absorbed Power		Note Notes
								DC	AC	
TR	1499	11	STILE IN LED 11 SE 6	SE	6	120		2 W		
	1499/24	24	STILE IN LED 24 SE 4	SE	4	180		2 W		
	1499L	11	STILE IN LED 11 SE 3/6	SE	3/6	220/130		2 W		
	1499BLU	11	STILE IN LED 11 SE8P	SE	6/18	130/60		2 W		Luce BLU

ACCESSORI - da ordinare separatamente / ACCESSORIES - to be ordered separately

SCHERMO BANDIERA/EDGE MOUNTED SCREEN
Solo vers. / Only versions 1499 -1499/24

BASSO / DOWN Cod. 4268
SX-DX / LH-RH Cod. 4267

TELECOMANDO INIBIT RM
RM INIBIT REMOTE CONTROL

Cod. 2730

ADESIVI SX/DX/BASSO
LH/RH/DOWN STICKERS

Cod. 4278

STAFFE PARETE - CONTROSOFFITTO
WALL BRACKET - FALSE CEILING

Parete / Edge mounting - Cod. 4265
Controsoffitto / False ceiling - Cod. 4264

SCHERMI SX/DX/BASSO
LH/RH/DOWN SCREENS

Serigrafia su policarbonato opale
Screen print on opal polycarbonate

Cod. 4269

GRIGLIA DI PROTEZIONE
PROTECTIVE GRID

440x215x99 mm

Cod. 3912

MODULO RM / RM MODULE

Solo per apparecchi Cod. 1499BLU
Only for Cod. 1499BLU

Cod. 15048

SCATOLA DA INCASSO
RECESSED BOX

Cod. 3733

Stile In SanificaAria

emergenza / emergency



Caratteristiche emergenza

Installazioni Parete, soffitto, incasso, controsoffitto

Corpo Policarbonato bianco RAL 9003

Ottica Convogliatore di flusso antiabbagliamento in PMMA

Schermo Policarbonato trasparente

Conformità EN60598-1, EN60598-2-2, EN60598-2-22, EN60335-2-65, ISO 15714, 2014/30/UE, 2014/35/UE

Applicazioni

Terziario, ospedali, attività commerciali, negozi, ristoranti, uffici, scuole

Emergency features

Mounting Wall, ceiling, recessed, false ceiling

Housing Polycarbonate, white RAL 9003

Optics PMMA anti-glare diffuser

Screen Clear polycarbonate

Compliance EN60598-1, EN60598-2-2, EN60598-2-22, EN60335-2-65, ISO 15714, 2014/30/EU, 2014/35/EU

Applications

Service sectors, hospitals, commercial activities, shops, restaurants, offices, schools

Caratteristiche delsanificatore

Specifications of the Air Purifier

Input power uvOxy®	10 W
UV-C wavelength	254nm
Sanitisation flow rate	4 m ³ /h
UV-C power	7W
UV-C radiation power	2.4W

ESEMPIO DI SANIFICAZIONE INIZIALE EXAMPLE OF INITIAL SANITISATION

Dimensioni ambiente / Room size		
m ³	m ²	h
10	4	2.5
20	8	5
30	12.5	7.5
40	16.5	10
60	25	15

Dimensioni Dimensions mm				Distanza di visibilità Distance of visibility (DV)	
L	B	H	H1	schermo	bandiera
295	102	55	44	15m	20m

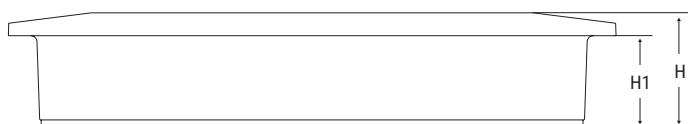
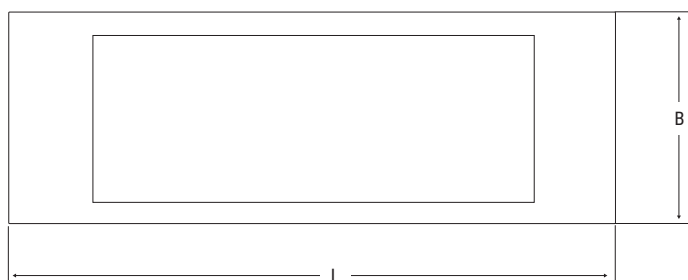

Prestazioni secondo EN 1838 / Performance according to EN 1838

NORMA UNI EN 1838	Altezza apparecchio Height	Interasse fra gli apparecchi Centre distance VIE DI ESODO - ESCAPE ROUTES		Area illuminata da ogni apparecchio Illuminated surface area GRANDI AREE / LARGE AREAS	
	(m)	Parete / Wall (m)	Plafone / Ceiling (m)	Parete / Wall (m)	Plafone / Ceiling (m)
	2.5	5	-	3x3	-
	3	-	7	-	5x5
		illuminamento >1lx a pavimento lungo la linea centrale senza riflessioni Emax/Emin <40 lighting >1lx at floor level along the centre line without reflection Emax/Emin <40		illuminamento >0,5lx a pavimento senza riflessioni Emax/Emin <40 lighting >0,5lx at floor level without reflections Emax/Emin <40	

STILE IN SanificaAria

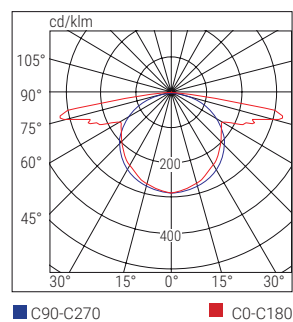

	Portata fino a Flow rate up to 4 m³/h	Tempo di sanificazione iniziale Initial sanitisation time 5h	Tempo di sanificazione iniziale Initial sanitisation time 6h
--	---	--	--

Prestazioni riferite al modello 1499LUV 120lm installato a parete
Performance with reference to luminaire 1499LUV 120lm installed on the wall

TR	Cod.	W eq.	Descrizione Description	Versione Version	Autonomia Autonomy h	Flusso Flux SE lm	Flusso Flux SA lm	Flusso di Sanificazione Sanitisation flow rate m³/h			Assorbimento Absorbed Power W	
								1	2	3		
	1499LUV	11	STILE IN LED SE TR UVOXY	SE	8	120	-	4	-	-	2.1	10

ACCESSORI - in dotazione / ACCESSORIES - included



SCATOLA DA INCASSO
RECESSED BOX

Cod. **3733**

ACCESSORI - da ordinare separatamente / ACCESSORIES - to be ordered separately



RICAMBIO CARTUCCIA SANIFICANTE
uvOxy® STILE IN / SPARE PART
uvOxy® STILE IN PURIFICATION CARTRIDGE

Durata 12 mesi, con utilizzo continuo 24h/giorno
Duration 12 months, at a continuous use 24h/day

Cod. **26724**



STAFFE CONTROSOFFITTO
FALSE CEILING BRACKETS

Foro incasso: 279x94 mm
Recessed mounting hole: 279x94 mm

Cod. **4264**



SCHERMI SX/DX/BASSO
LH/RH/DOWN SCREENS

Serigrafia su policarbonato opale
Screen print on opal polycarbonate

Cod. **4269**



GRIGLIA DI PROTEZIONE
PROTECTIVE GRID

440x215x99 mm

Cod. **3912**



ADESIVI SX/DX/BASSO
LH/RH/DOWN STICKERS

Cod. **4278**

Lungalargaluce Extreme

emergenza / emergency



WEB
CATALOGUE



IP65

IK09



CTS - HT



Caratteristiche

Installazioni Parete, soffitto, incasso

Corpo Alluminio pressofuso, RAL 7040

Ottica Lenti in policarbonato trasparente

Conformità EN 60598-1, EN 60598-2-2, EN 60598-2-22, EN 1838, UNI 11222, ATEX 2014/34/UE (classificazione: II 3 G Ex nA II B T135, II 3 D Ex tD A22 T85)

Applicazioni

Industriali in ambienti ad altro rischio con presenza di polveri e sostanze esplosive.

Characteristics

Mounting Wall, ceiling, recessed

Housing Die-cast aluminium, RAL 7040

Optics Clear polycarbonate lenses

Compliance EN 60598-1, EN 60598-2-2, EN 60598-2-22, EN 1838, UNI 11222, ATEX 2014/34/EU (classification: II 3 G Ex nA II B T135, II 3 D Ex tD A22 T85)

Applications

Industrial, in high-risk environments with dust and explosive substances.

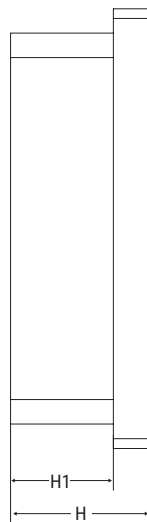
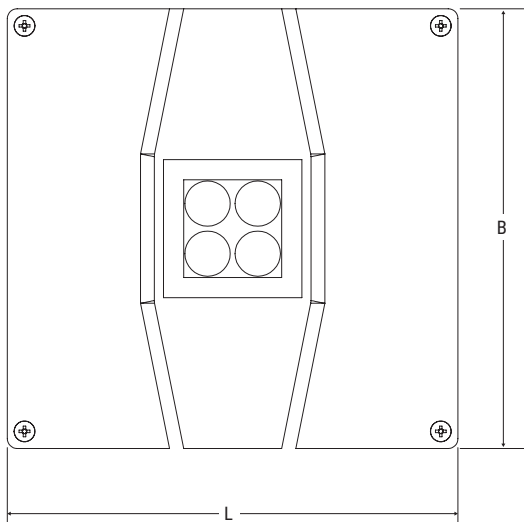



Dimensioni
Dimensions
mm

L	B	H	H1
183	179	57	42

090

Prestazioni secondo EN 1838 / Performance according to EN 1838

Lente Lens	Altezza apparecchio Height 	Interasse fra gli apparecchi Centre distance VIE DI ESODO - ESCAPE ROUTES 		Area illuminata da ogni apparecchio Illuminated surface area GRANDI AREE / LARGE AREAS 	
		(m)	Parete / Wall (m)	Plafone / Ceiling (m)	Parete / Wall (m)
Lungaluce 3m	3	-	15	-	-
Lungaluce 7m	7	-	22	-	-
Largaluce 3m	3	-	-	-	12x12
Largaluce 7m	7	-	-	-	13x13
Altorischio	7	-	-	-	Ø 3m - 30lx

illuminamento >1lx a pavimento lungo la linea centrale senza riflessioni Emax/Emin <40
lighting >1lx at floor level along the centre line without reflection Emax/Emin <40

illuminamento >0,5lx a pavimento senza riflessioni Emax/Emin <40
lighting >0,5lx at floor level without reflections Emax/Emin <40

Prestazioni riferite all'apparecchio Cod. 19370 1155lm
Performance with reference to luminaire Cod. 19370 1155lm

Coefficiente di manutenzione 0.8
Maintenance coefficient 0.8

ALTORISCHIO 89%

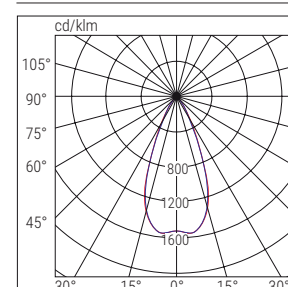

■ C0-C180 ■ C90-C270

LUNGALUCE 3m 88%

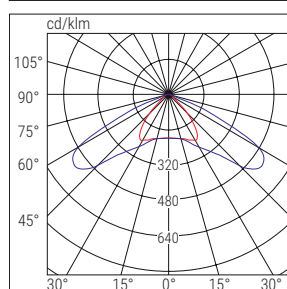

■ C0-C180 ■ C90-C270

LUNGALUCE 7m 82%

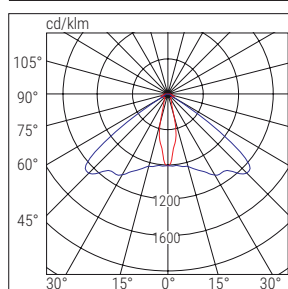

■ C0-C180 ■ C90-C270

LARGALUCE 3m 92%

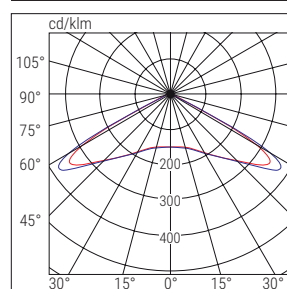

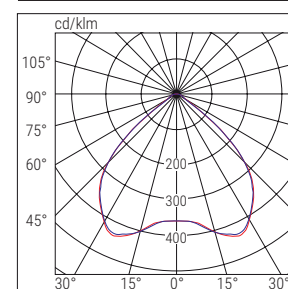

■ C0-C180 ■ C90-C270

LARGALUCE 7m 89%



■ C0-C180 ■ C90-C270

	Cod.	W eq.	Descrizione Description	Versione Version	Autonomia Autonomy h	Flusso Flux SE lm	Flusso Flux SA lm	Assorbimento Absorbed Power		Note Notes
								DC	AC	
AT	19396	24	LUNGALARGALUCE EX AT	SE/SA	1/1.5/2/3/8	1155/770/575/385/144	575		7.5 W	
CT	19370	24	LUNGALARGALUCE EX CT	SE/SA	1/1.5/2/3/8	1155/770/575/385/144	575		7.5 W	
	19378	24	LUNGALARGALUCE EX GL CT	SE/SA	1/1.5/2/3/8	1800/1200/900/600/300	575		7.5 W	
Gli apparecchi CT possono integrare dispositivi opzionali per l'espansione ad altri sistemi: Modulo LG cod.15036 - Modulo LGFM IP65 Cod.15047 - Modulo DALI cod.15038 The CT luminaires can integrate optional devices for expansion to other systems: LG Module cod.15036 - LGFM Module cod.15037 - DALI Module cod.15038										
CTS	LG230									
	31112	24	L.LARGA EXTREME LG230 LS-UV	SE/SA		1400	1400	11.2 W	24.1 VA	
	LG24									
	32083	24	L.LARGA EXTREME LG24 LS-UV	SE/SA		1100	1400	7.4 W	22.2 VA	
HT	LG EPS									
	31308	36GL	L.LARGA EXTREME LG EPS DALI	SE/SA		1400	1400		11.3 VA	
HT	HT230									
	31113	24	L.LARGA EXTREME HT	HT		1400	1400	10.7 W	22.2 VA	

SEGUE / NEXT >

Lungalargaluce Extreme

emergenza / emergency

ACCESSORI - in dotazione / ACCESSORIES - included



PRESSACAVO M20 ACCIAIO
CABLE GLAND M20 STEEL



LENTE LARGALUCE 3m
LARGALUCE LENS 3m
Montata di serie / fitted as standard



LENTE LUNGALUCE 3m
LUNGALUCE LENS 3m



LENTE LARGALUCE 7m
LARGALUCE LENS 7m



LENTE LUNGALUCE 7m
LUNGALUCE LENS 7m



LENTE ALTORISCHIO
HIGH RISK LENS

ACCESSORI - da ordinare separatamente / ACCESSORIES - to be ordered separately



STAFFA ORIENTABILE
SWIVEL BRACKET

Cod. 15043



MODULO LG - LGFM - DALI
solo per apparecchi CT / CT version only
LG - Cod. 15036
LGFM IP65 - Cod. 15049
DALI - Cod. 15038

LG
LGFM
DALI



STAFFE CARTONGESSO
PLASTERBOARD BRACKETS

Cod. 15044



093 faretti / spotlights

Lungalargaluce

emergenza / emergency



WEB
CATALOGUE



IP41

IK07

850°

CTS - HT
+40°C
-20°C



+40°C
0°C

Caratteristiche

Installazioni Soffitto

Corpo Policarbonato bianco RAL 9010

Ottica Lenti in PMMA ad elevata trasparenza

Conformità EN 60598-1, EN 60598-2-22, UNI EN 1838, UNI 11222, EN 62034

Applicazioni

Industriale, terziario, magazzini, scuole, ospedali, negozi, centri commerciali, uffici

Characteristics

Mounting Ceiling

Housing Polycarbonate, white RAL 9010

Optics Highly transparent PMMA lenses

Compliance EN 60598-1, EN 60598-2-22, UNI EN 1838, UNI 11222, EN 62034

Applications

Industry, service sectors, warehouses, schools, hospitals, shops, shopping centres, offices

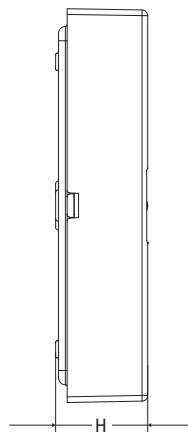
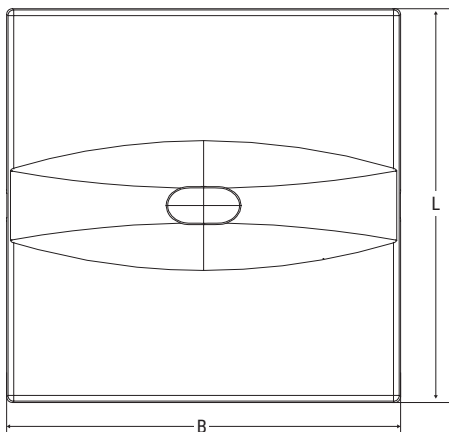

Dimensioni
Dimensions
mm

L	B	H
137	137	32

Prestazioni secondo EN 1838 / Performance according to EN 1838

Lente Lens	Altezza apparecchio Height	Interasse fra gli apparecchi Centre distance VIE DI ESODO - ESCAPE ROUTES		Area illuminata da ogni apparecchio Illuminated surface area GRANDI AREE / LARGE AREAS	
	(m)	Parete / Wall (m)	Plafone / Ceiling (m)	Parete / Wall (m)	Plafone / Ceiling (m)
Lungaluce	3	-	20	-	-
Largaluce	3	-	-	-	12x12
illuminamento >1lx a pavimento lungo la linea centrale senza riflessioni Emax/Emin <40 lighting >1lx at floor level along the centre line without reflection Emax/Emin <40			illuminamento >0,5lx a pavimento senza riflessioni Emax/Emin <40 lighting >0,5lx at floor level without reflections Emax/Emin <40		

Prestazioni riferite all'apparecchio Cod. 19329 450lm
Performance with reference to luminaire Cod. 19329 450lm

Coefficiente di manutenzione 0.8
Maintenance coefficient 0.8

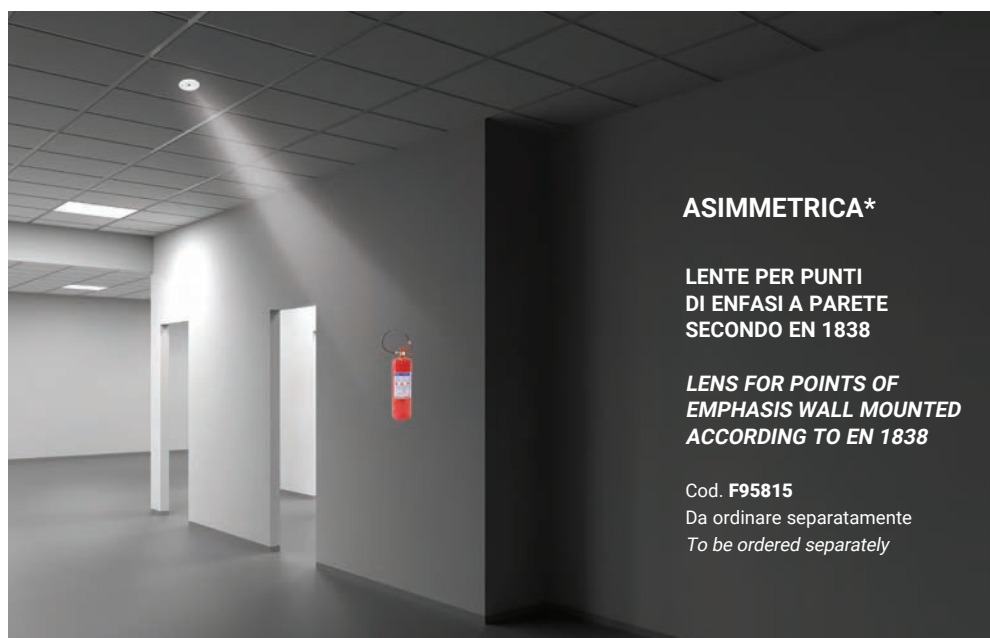

LUNGALUCE 87%

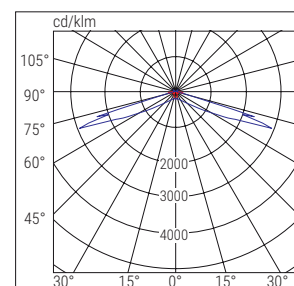

■ C90-C270 ■ C0-C180

LARGALUCE 95%

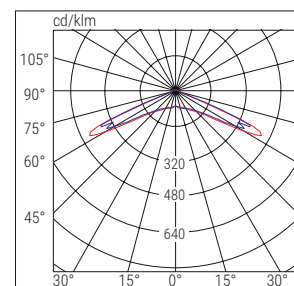

■ C90-C270 ■ C0-C180

DIFFUSALUCE 85%

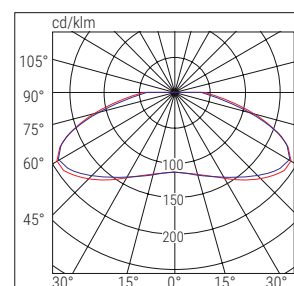

■ C90-C270 ■ C0-C180

	Cod.	W eq.	Descrizione Description	Versione Version	Autonomia Autonomy h	Flusso Flux SE Im	Flusso Flux SA Im	Assorbimento Absorbed Power		Note Notes	
								DC	AC		
CT	19328	24	L.LARG DWCL CT 24W SA	SE/SA/PS	1/1.5/2/3/8	250/200/150/80/50	220		5 W		
	19329	24GL	L.LARG DWCL CT 24W GL SA	SE/SA/PS	1/1.5/2/3/8	450/330/250/160/70	220		5 W		
Gli apparecchi CT possono integrare dispositivi opzionali per l'espansione ad altri sistemi: Modulo LG cod.15036 - Modulo LGFM Cod.15037 - Modulo DALI cod.15038 The CT luminaires can integrate optional devices for expansion to other systems: LG Module cod.15036 - LGFM Module cod.15037 - DALI Module cod.15038											
CTS	LG230										
	17876	24	L.LARG DWCL LG230	SE/SA		380	380	4.1 W	8.3 VA		
	LG24										
	17877	24	L.LARGA DWCL LG24 LS-UV	SE/SA		380	380	3.8 W			
HT	LGEPS										
	31306	24	L.LARG DWCL LG EPS DALI	SE/SA		380	380		8.3 VA		
HT	HT230										
	19320	24	L.LARG DWCL HT 24W	HT		380	380	4.8 W	9.6 VA		

SEGUE / NEXT >

Lungalargaluce

emergenza / emergency

ACCESSORI - in dotazione / ACCESSORIES - included

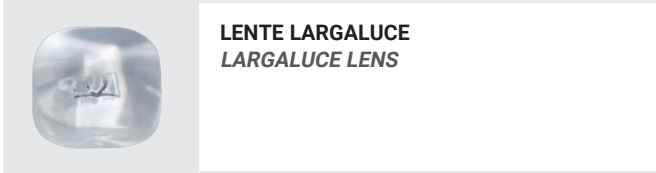
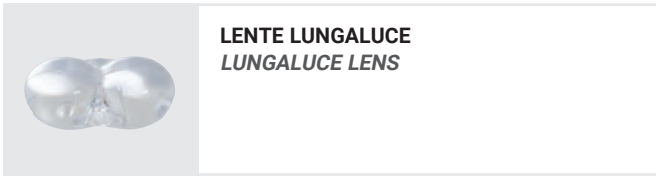

ACCESSORI - da ordinare separatamente / ACCESSORIES - to be ordered separately

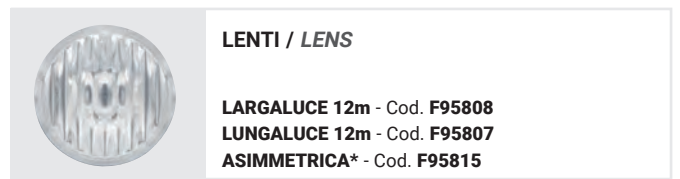

LARGALUCE 7m 87%

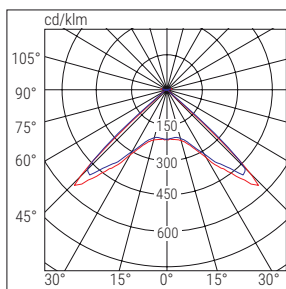

■ C90-C270 ■ C0-C180

LARGALUCE 12m 87%

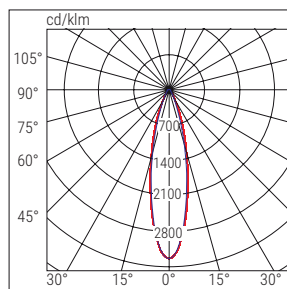

■ C90-C270 ■ C0-C180

LUNGALUCE 12 m 87%

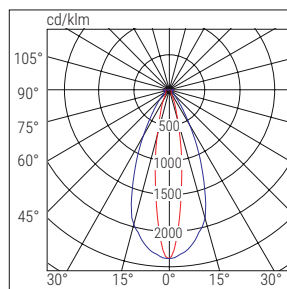

■ C90-C270 ■ C0-C180

ASIMMETRICA 87%

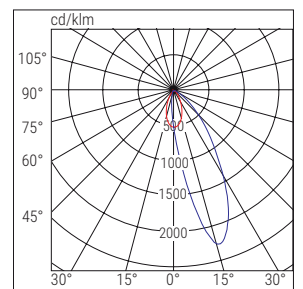

■ C90-C270 ■ C0-C180



097 faretti / spotlights

Lungalargaluce - incasso / recessed

emergenza / emergency



Caratteristiche

Installazioni Controsoffitto, incasso

Corpo Policarbonato bianco RAL 9010

Ottica lenti in PMMA ad elevata trasparenza

Conformità EN 60598-1, EN 60598-2-2, EN 60598-2-22, UNI EN 1838, UNI 11222, EN 62034

Applicazioni

Terziario, uffici, cinema, hotel, musei scuole, negozi, centri commerciali, show room di design

Characteristics

Mounting False ceiling, recessed

Housing Polycarbonate, white RAL 9010

Optics Highly transparent PMMA lenses

Compliance EN 60598-1, EN 60598-2-2, EN 60598-2-22, UNI EN 1838, UNI 11222, EN 62034

Applications

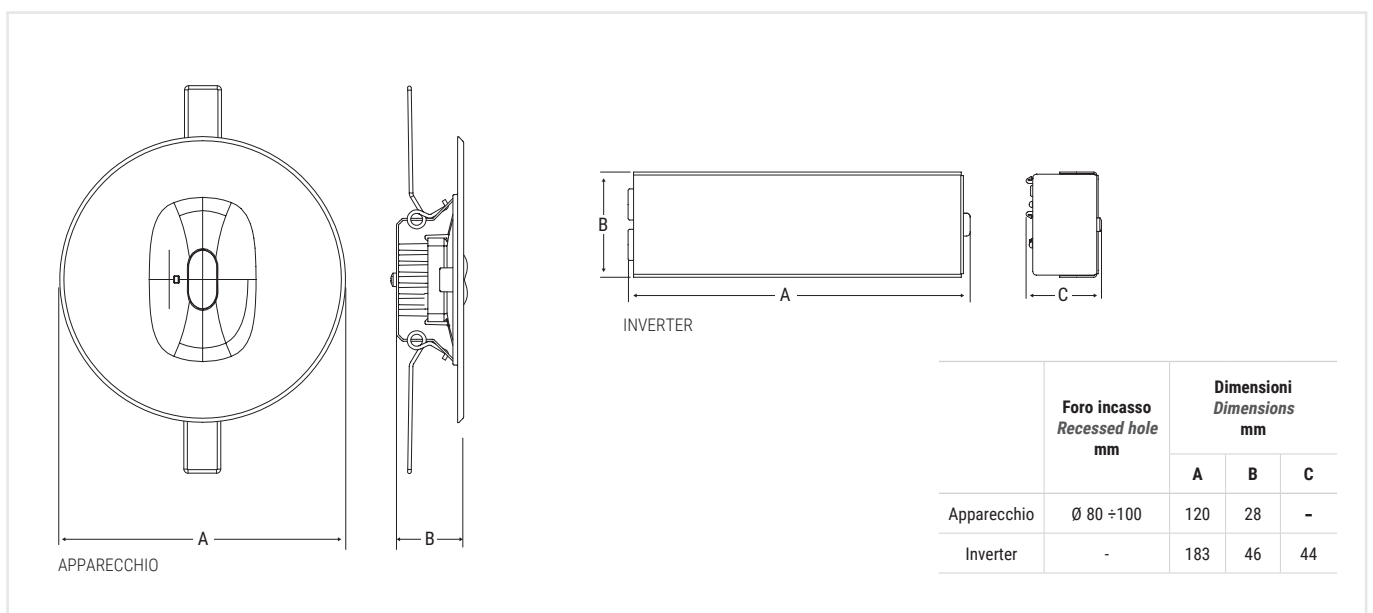

Service sectors, offices, cinemas, hotels, museums, schools, shops, shopping centres, design rooms



	Foro incasso Recessed hole mm	Dimensioni Dimensions mm		
		A	B	C
Apparecchio	Ø 80 ÷ 100	120	28	-
Inverter	-	183	46	44

mounting

Prestazioni secondo EN 1838 / Performance according to EN 1838

Lente Lens	Altezza apparecchio Height 	Interasse fra gli apparecchi Centre distance VIE DI ESODO - ESCAPE ROUTES 		Area illuminata da ogni apparecchio Illuminated surface area GRANDI AREE / LARGE AREAS 		
		(m)	Parete / Wall (m)	Plafone / Ceiling (m)	Parete / Wall (m)	Plafone / Ceiling (m)
Lungaluce	3	-	20	-	-	
Largaluce	3	-	-	-	12x12	
			illuminamento >1lx a pavimento lungo la linea centrale senza riflessioni Emax/Emin <40 lighting >1lx at floor level along the centre line without reflection Emax/Emin <40		illuminamento >0,5lx a pavimento senza riflessioni Emax/Emin <40 lighting >0,5lx at floor level without reflections Emax/Emin <40	

Prestazioni riferite all'apparecchio Cod. 19339 450lm
Performance with reference to luminaire Cod. 19339 450lm

Coefficiente di manutenzione 0.8
Maintenance coefficient 0.8

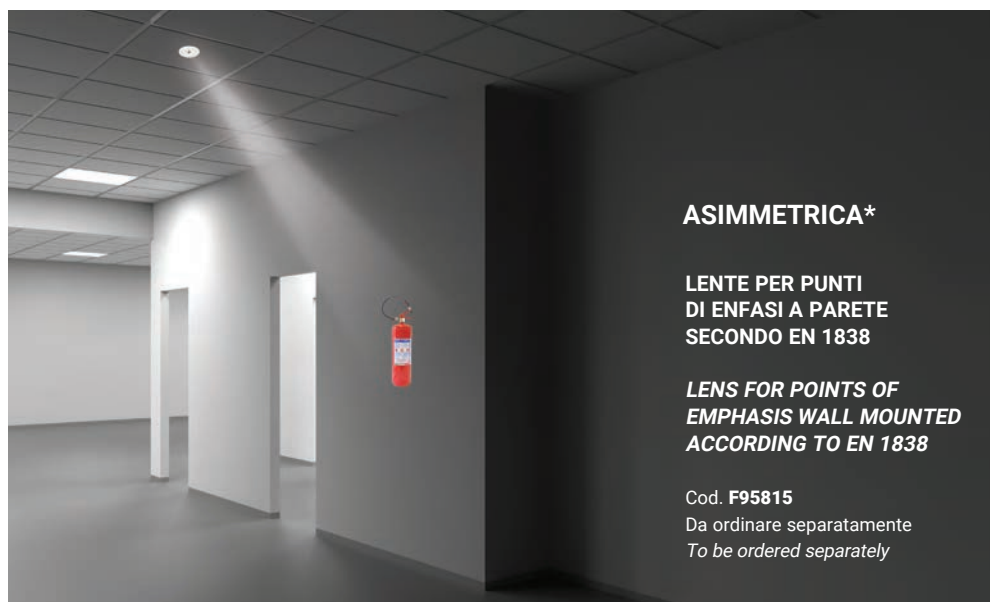

ASIMMETRICA*

LENTE PER PUNTI
DI ENFASI A PARETE
SECONDO EN 1838

LENS FOR POINTS OF
EMPHASIS WALL MOUNTED
ACCORDING TO EN 1838

Cod. F95815
Da ordinare separatamente
To be ordered separately

LUNGALUCE 87%

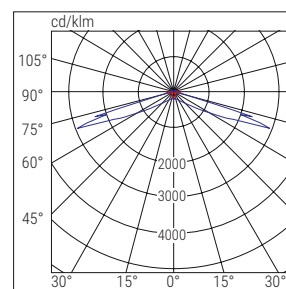

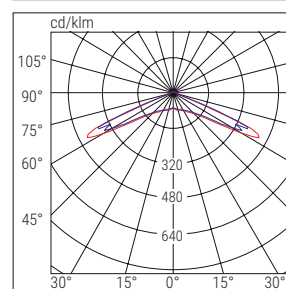

■ C90-C270 ■ C0-C180

LARGALUCE 95%



■ C90-C270 ■ C0-C180

	Cod.	W eq.	Descrizione Description	Versione Version	Autonomia Autonomy h	Flusso Flux SE lm	Flusso Flux SA lm	Assorbimento Absorbed Power		Note Notes
								DC	AC	
CT	19338	24	LLARG DWRC CT 24W SA	SE/SA/PS	1/1.5/ 2/3/8	250/200/150/80/50	220		5 W	
	19339	24GL	LLARG DWRC CT 24W GL SA	SE/SA/PS	1/1.5/ 2/3/8	450/330/250/160/70	220		5 W	
<p>Gli apparecchi CT possono integrare dispositivi opzionali per l'espansione ad altri sistemi: Modulo LG cod.15036 - Modulo LGFM Cod.15037 - Modulo DALI cod.15038 The CT luminaires can integrate optional devices for expansion to other systems: LG Module cod.15036 - LGFM Module cod.15037 - DALI Module cod.15038</p>										
CTS	LG230									
	17878	24	L.LARGA DWRC LG230	SE/SA		380	380	4.1 W	8.3 VA	
	LG24									
	17879	24	L.LARGA DWRC LG24 LS-UV	SE/SA		380	380	3.8 W		
HT	LG EPS									
	31307	24	L.LARGA DWRC LG EPS DALI	SE/SA		380	380		8.3 VA	
HT	HT230									
	19330	24	L.LARG DWRC HT 24W	HT		380	380	4.8 W	9.6 VA	

SEGUE / NEXT >

Lungalargaluce - incasso / recessed

emergenza / emergency

ACCESSORI - in dotazione / ACCESSORIES - included

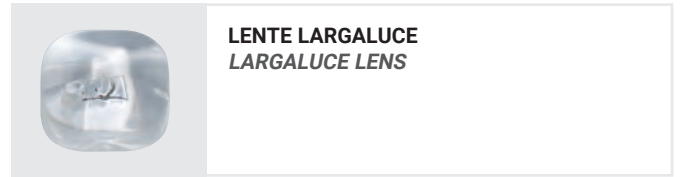
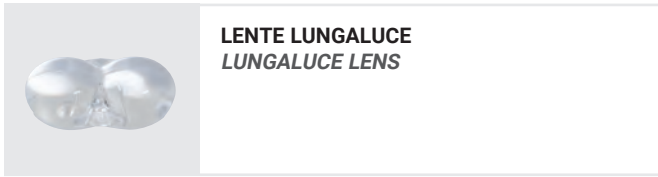

ACCESSORI - da ordinare separatamente / ACCESSORIES - to be ordered separately

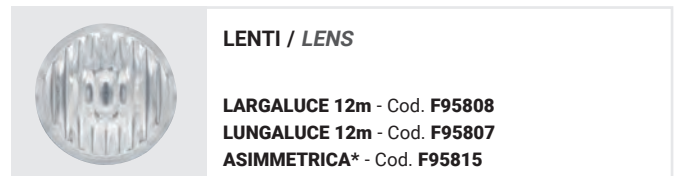

LARGALUCE 7m 87%

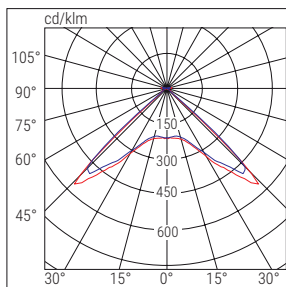

■ C90-C270 ■ C0-C180

LARGALUCE 12m 87%

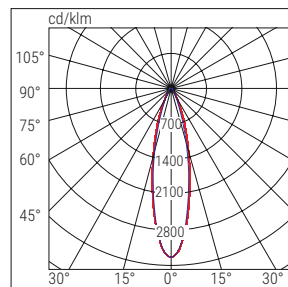

■ C90-C270 ■ C0-C180

LUNGALUCE 12 m 87%

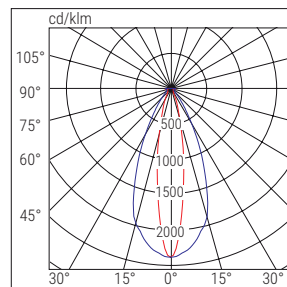

■ C90-C270 ■ C0-C180

ASIMMETRICA 87%

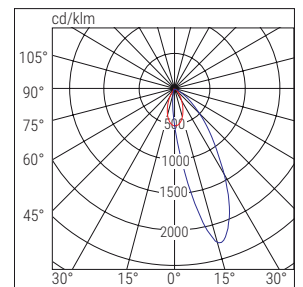

■ C90-C270 ■ C0-C180

mounting



101 faretti / spotlights

Multi Lens

emergenza / emergency



Caratteristiche

Installazioni Incasso

Corpo Policarbonato

Ottica Lenti in PMMA con elevata trasparenza

Conformità EN 60598-1, EN 60598-2-2, EN 60598-2-22, UNI EN 1838, UNI 11222, EN 62034

Applicazioni

Terziario, uffici, cinema, hotel, scuole, negozi, centri commerciali, show room

Characteristics

Mounting Recessed

Housing Polycarbonate

Optics Highly transparent PMMA lenses



Compliance EN 60598-1, EN 60598-2-2, EN 60598-2-22, UNI EN 1838, UNI 11222, EN 62034

Applications

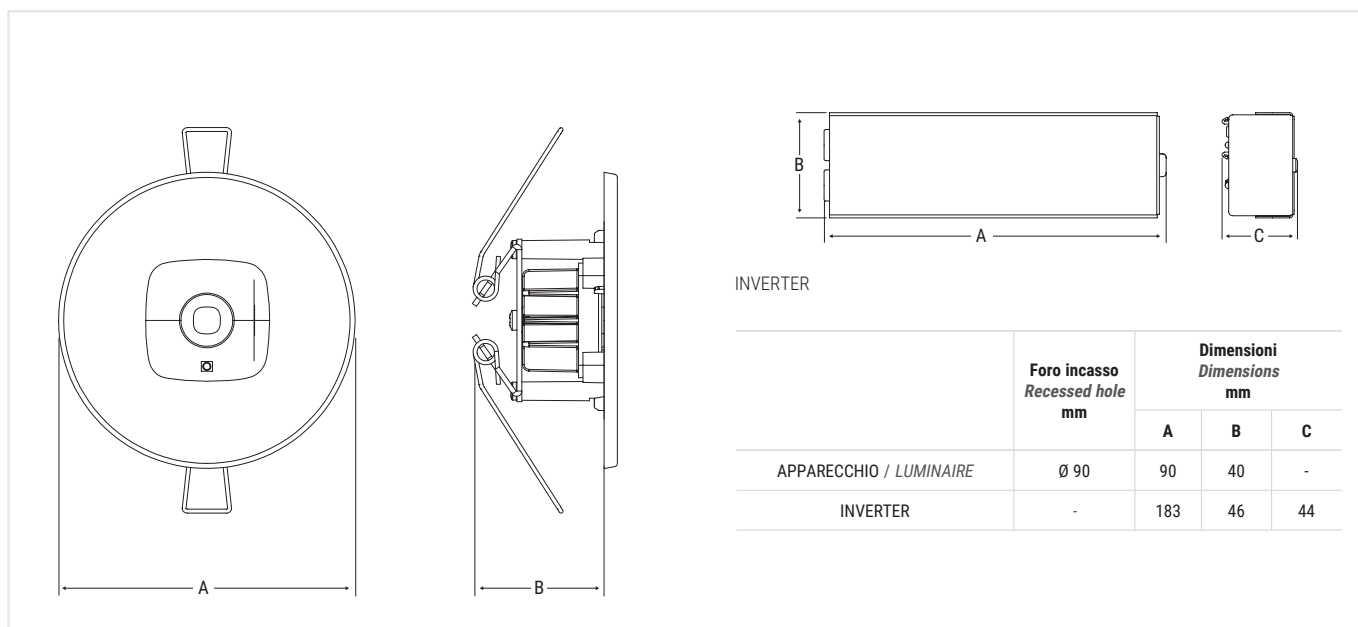
Service sectors, offices, cinemas, hotels, schools, shops, shopping centres, showrooms



Prestazioni secondo EN 1838 / Performance according to EN 1838

Lente Lens	Altezza apparecchio Height 	Interasse fra gli apparecchi Centre distance VIE DI ESODO - ESCAPE ROUTES 		Area illuminata da ogni apparecchio Illuminated surface area GRANDI AREE / LARGE AREAS 	
		(m)	Parete / Wall (m)	Plafone / Ceiling (m)	Parete / Wall (m)
Lungaluce	3	-	17	-	-
Largaluce	3	-	-	-	12x12
Altaluce	7	-	15	-	-

illuminamento >1lx a pavimento lungo la linea centrale senza riflessioni Emax/Emin <40
lighting >1lx at floor level along the centre line without reflection Emax/Emin <40

illuminamento >0,5lx a pavimento senza riflessioni Emax/Emin <40
lighting >0,5lx at floor level without reflections Emax/Emin <40

Prestazioni riferite all'apparecchio Cod. 4334 450lm
Performance with reference to luminaire Cod. 4334 450lm

Coefficiente di manutenzione 0.8
Maintenance coefficient 0.8

LUNGALUCE

87%

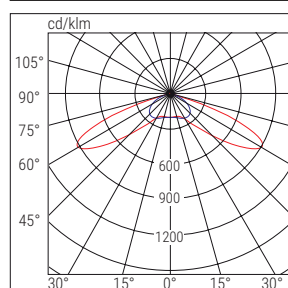

■ C90-C270 ■ C0-C180

LARGALUCE

92%

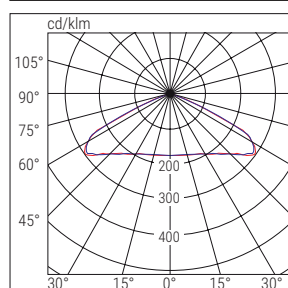



■ C90-C270 ■ C0-C180

ALTALUCE

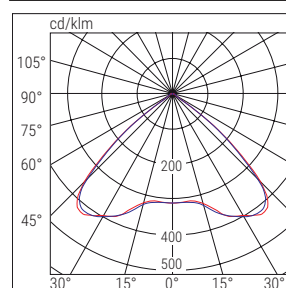
85%



■ C90-C270 ■ C0-C180

	Cod.	W eq.	Descrizione Description	Versione Version	Autonomia Autonomy h	Flusso Flux SE lm	Flusso Flux SA lm	Assorbimento Absorbed Power		Note Notes
								DC	AC	
TR	4330	24	MULTI LENS 60MM SE 1H RM	SE	1	250			1.0 W	
	4331	11	MULTI LENS 60MM SE 3H RM	SE	3	150			1.5 W	
	4334	24GL	MULTI LENS GL 60MM SA 123H RM	SE/SA	1/2/3	450/250/150	220		3.0 W	
	4335	24GL	MULTI LENS GL 60MM SA 236H RM	SE/SA	2/3/6	450/300/150	220		3.0 W	
AT	4395	24	MULTI LENS AT SE	SE	1/1.5/2/3/8	250/200/150/80/50			2.2W	
	4396	24	MULTI LENS AT SA	SE/SA/PS	1/1.5/2/3/8	250/200/150/80/50	220		5.0 W	
	4394	24GL	MULTI LENS GL AT SA	SE/SA/PS	1/1.5/2/3/8	450/330/250/160/70	220		5.0 W	
CT	4390	24	MULTI LENS CT SE	SE	1/1.5/2/3/8	250/200/150/80/50			2.2W	
	4391	24	MULTI LENS CT SA	SE/SA/PS	1/1.5/2/3/8	250/200/150/80/50	220		5.0 W	
	4393	24GL	MULTI LENS GL CT SA	SE/SA/PS	1/1.5/2/3/8	450/330/250/160/70	220		5.0 W	
<p>Gli apparecchi CT possono integrare dispositivi opzionali per l'espansione ad altri sistemi: Modulo LG cod.15036 - Modulo LGFM Cod.15037 - Modulo DALI cod.15038 The CT luminaires can integrate optional devices for expansion to other systems: LG Module cod.15036 - LGFM Module cod.15037 - DALI Module cod.15038</p>										
CTS	LG230									
	31218	24	MULTI LENS LG230	SE/SA		380	380	4.1 W	8.3 VA	
CTS	LG24									
	32127	24	MULTI LENS LG24	SE/SA		380	380	3.8 W		
HT	HT230									
	31219	24	MULTI LENS HT	HT		380	380	4.8 W	9.6 VA	

Multi Lens

ACCESSORI - in dotazione / ACCESSORIES - included



LENTE LUNGALUCE CON COVER
LENTE LUNGALUCE CON COVER



LENTE ALTALUCE CON COVER
LENTE ALTALUCE CON COVER



LENTE LARGALUCE CON COVER
LENTE LARGALUCE CON COVER

ACCESSORI - da ordinare separatamente / ACCESSORIES - to be ordered separately



MODULO / MODULE LG - LGFM - DALI

Solo per apparecchi CT / CT version only

LG - Cod. 15036

LGFM - Cod. 15037

DALI - Cod. 15038

LG
LGFM
DALI



TELECOMANDO INIBIT RM
RM INIBIT REMOTE CONTROL

Solo apparecchi TR e AT equipaggiati di modulo RM
Only TR and AT devices equipped with RM module

Cod. 2730

RM



105 faretti / spotlights

Triangle

emergenza / emergency



WEB CATALOGUE



IP66

IK09

960°

CTS - HT
+40°C
-20°C



+40°C
0°C

Caratteristiche

Installazioni Parete

Corpo Acciaio Inox e acciaio verniciato alle polveri, bianco RAL 9010

Ottica PMMA ad elevata trasparenza

Conformità EN 60598-1, EN 60598-2-22, EN 60598-2-2, EN 62034, UNI EN 1838, UNI 11222, EN 60598-2-22

Applicazioni

Industriale, terziario, ospedali, hotel

Characteristics

Mounting Wall

Housing Inox, powder coated stainless steel, white RAL 9010

Optics Highly transparent PMMA lenses

Compliance EN 60598-1, EN 60598-2-22, EN 60598-2-2, EN 62034, UNI EN 1838, UNI 11222, EN 60598-2-22

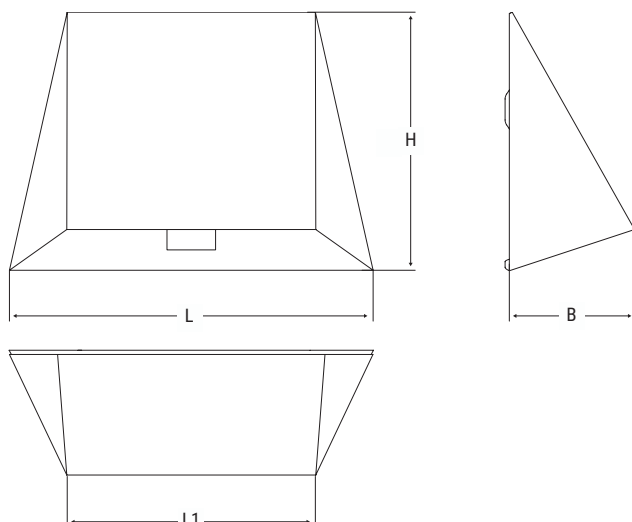

Applications

Industry, service sectors, hospitals, hotels



Versione Version	Dimensioni Dimensions mm			
	L	L1	B	H
CT	241	163	76	190
CTS-HT	221	157	64	156

Prestazioni secondo EN 1838 / Performance according to EN 1838

Lente Lens	Altezza apparecchio Height 	Interasse fra gli apparecchi Centre distance VIE DI ESODO - ESCAPE ROUTES 		Area illuminata da ogni apparecchio Illuminated surface area GRANDI AREE / LARGE AREAS 	
		(m)	Parete / Wall (m)	Plafone / Ceiling (m)	Parete / Wall (m)
Asimmetrica	2,5	12	-	2,5x8	-
Largaluce 3,5m	3,5	10	-	4,5x8	-
Largaluce 7m	7	13	-	7x8	-
		illuminamento >1lx a pavimento lungo la linea centrale senza riflessioni Emax/Emin <40 lighting >1lx at floor level along the centre line without reflection Emax/Emin <40		illuminamento >0,5lx a pavimento senza riflessioni Emax/Emin <40 lighting >0,5lx at floor level without reflections Emax/Emin <40	

Prestazioni riferite all'apparecchio Cod. 31056 312lm
Performance with reference to luminaire Cod. 31056 312lm

Coefficiente di manutenzione 0.8
Maintenance coefficient 0.8



LARGALUCE 3.5m

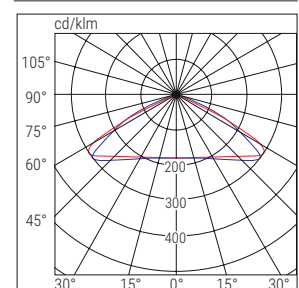

■ C0-C180 ■ C90-C270

LARGALUCE 7m

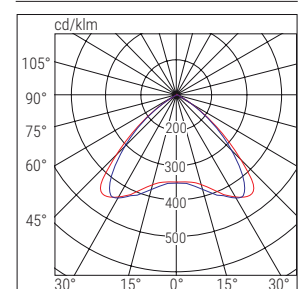

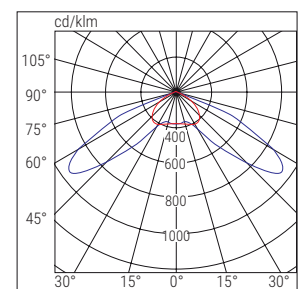

■ C0-C180 ■ C90-C270

ASIMMETRICA



■ C0-C180 ■ C90-C270

	Cod.	W eq.	Descrizione Description	Versione Version	Autonomia Autonomy h	Flusso Flux SE lm	Flusso Flux SA lm	Assorbimento Absorbed Power		Note Notes	
								DC	AC		
CT	37270	24	TRIANGLE CT	SE/SA/PS	1/1.5/2/3/8	288/288/230/165/58	220		5W		
	37273	24	TRIANGLE INOX CT	SE/SA/PS	1/1.5/2/3/8	288/288/230/165/58	220		5W		
CTS	LG230										
	31056	24	TRIANGLE LG230	SE/SA		312	312	4.1W	8.3 VA		
	31057	24	TRIANGLE INOX LG230	SE/SA		312	312	4.1W	8.3VA		
	LG24										
	32057	24	TRIANGLE LG24	SE/SA		312	312	3.8W			
	32058	24	TRIANGLE INOX LG24	SE/SA		312	312	3.8W			
HT	LG EPS										
	31312	24	TRIANGLE LG EPS DALI	SE/SA		312	312		8.3VA		
	31313	24	TRIANGLE INOX LG EPS DALI	SE/SA		312	312		8.3VA		
HT	31314	24	TRIANGLE HT	HT		312	312	4.1W	8.3VA		
	31315	24	TRIANGLE INOX HT	HT		312	312	4.1W	8.3VA		



Caratteristiche

Installazioni Parete, plafone

Corpo PHA bianco RAL 9003

Ottica In PMMA

Conformità EN 60598-1, EN 60598-2-22, UNI EN 1838, UNI 11222, EN 62034

Applicazioni

Terziario e civile, anche in situazioni di design dove è richiesta particolare cura nel ridurre l'impatto estetico dell'illuminazione di emergenza.

Characteristics

Mounting Wall, ceiling

Housing Polycarbonate, white RAL 9003

Optics PMMA

Compliance EN 60598-1, EN 60598-2-22, UNI EN 1838, UNI 11222, EN 62034

Applications

Service sectors and residential, even in design situations where special care is required to reduce the aesthetic impact of emergency lighting.

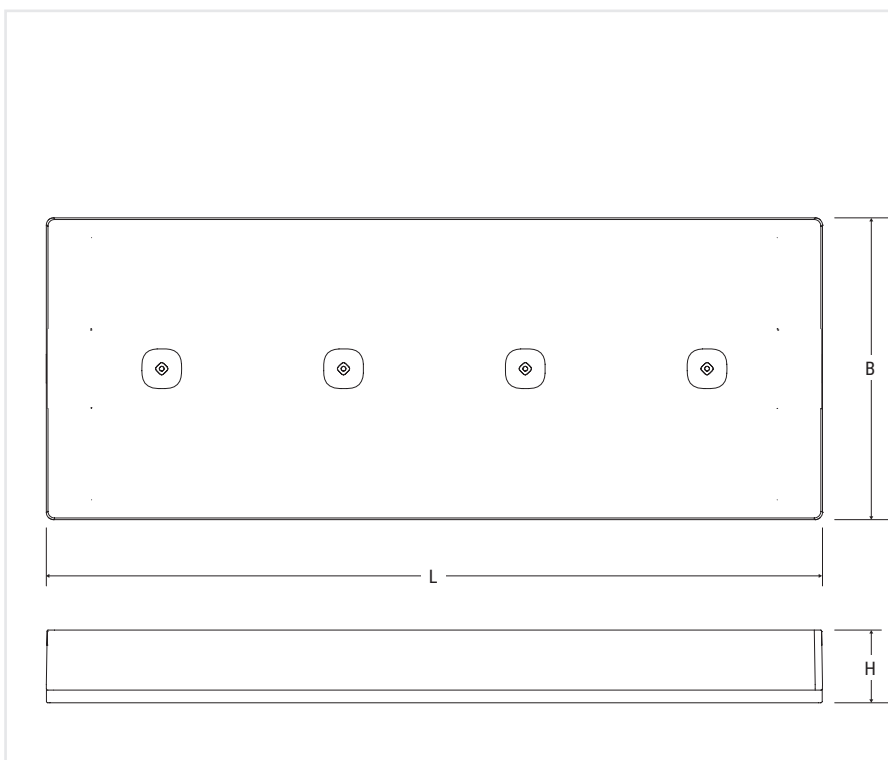

Dimensioni Dimensions mm			Distanza di visibilità (DV)
L	B	H	
213	83	20	16 m

Prestazioni secondo EN 1838 / Performance according to EN 1838

Altezza apparecchio Height	Interasse fra gli apparecchi Centre distance VIE DI ESODO - ESCAPE ROUTES		Area illuminata da ogni apparecchio Illuminated surface area GRANDI AREE / LARGE AREAS	
	(m)	Parete / Wall (m)	Plafone / Ceiling (m)	Parete / Wall (m)
2.5	7	-	5x6	-
3	-	10	-	7x7

illuminamento >1lx a pavimento lungo la linea centrale senza riflessioni Emax/Emin <40
lighting >1lx at floor level along the centre line without reflection Emax/Emin <40

illuminamento >0,5lx a pavimento senza riflessioni Emax/Emin <40
lighting >0,5lx at floor level without reflections Emax/Emin <40

NU.DA

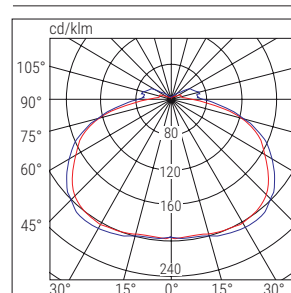

■ C0-C180 ■ C90-C270

Prestazioni riferite all'apparecchio Cod. 19601 300 lm
Performance with reference to luminaire Cod. 19601 300 lm

Coefficiente di manutenzione 0,8
Maintenance coefficient 0,8

	Cod. ord.	W eq.	Descrizione Description	Versione Version	Autonomia Autonomy h	Flusso Flux SE lm	Flusso Flux SA lm	Assorbimento Absorbed Power		Note Notes
								DC	AC	
TR	19600	11	NU.DA AE SE 1/1.5/3 TR	SE	1/1.5/3	200/160/100			1 W	
	19601	24	NU.DA AE SE 1.5/3 TR	SE	1.5/3	300/160			1.3 W	
	19602	11	NU.DA AE SE/SA 1/1.5/3 TR	SE/SA	1/1.5/3	200/160/100	100		1.6 W	
	19603	24	NU.DA AE SE/SA 1.5/3 TR	SE/SA	1.5/3	300/160	170		2.5 W	
AT	19628	11-24	NU.DA 1124 AE AT SE	SE	1/1.5/2/3/8	250/170/130/85/35			1.7 W	
	19629	24-36	NU.DA 2436 AE AT SE	SE	1/1.5/2/3/8	450/305/230/155/65	170		1.7 W	
	19630	11-24	NU.DA 1124 AE AT SE/SA	SE/SA	1/1.5/2/3/8	250/170/130/85/35			3 W	
	19631	24-36	NU.DA 2436 AE AT SE/SA	SE/SA	1/1.5/2/3/8	450/305/230/155/65	170		3 W	
CT	19620	11-24	NU.DA 1124 AE CT SE	SE	1/1.5/2/3/8	250/170/130/85/35			1.7 W	
	19621	24-36	NU.DA 2436 AE CT SE	SE	1/1.5/2/3/8	450/305/230/155/65	170		1.7 W	
	19622	11-24	NU.DA 1124 AE CT SE/SA	SE/SA	1/1.5/2/3/8	250/170/130/85/35			3 W	
	19623	24-36	NU.DA 2436 AE CT SE/SA	SE/SA	1/1.5/2/3/8	450/305/230/155/65	170		3 W	

Gli apparecchi CT possono integrare dispositivi opzionali per l'espansione ad altri sistemi: Modulo LG cod.15036 - Modulo LGFM Cod.15037 - Modulo DALI cod.15038
The CT luminaires can integrate optional devices for expansion to other systems: LG Module cod.15036 - LGFM Module cod.15037 - DALI Module cod.15038

ACCESSORI - da ordinare separatamente

 **MODULO / MODULE LG - LGFM - DALI**
Solo per apparecchi CT / CT version only

LG - Cod. 15036
LGFM - Cod. 15037
DALI - Cod. 15038

 **KIT BINARIO TRIFASE
THREE-PHASE TRACK KIT**

Cod. 4319

 **MODULO RM / RM MODULE**
Rest Mode

Cod. 15048

 **GRIGLIA DI PROTEZIONE
PROTECTIVE GRID**
305x135x80 mm

Cod. 18591

 **TELECOMANDO INIBIT RM
RM INIBIT REMOTE CONTROL**
Solo apparecchi TR e AT equipaggiati di modulo RM
Only TR and AT devices equipped with RM module

Cod. 2730

 **ADESIVI SX/DX/BASSO/ALTO
LH/RH/DOWN/UP STICKERS**

Cod. 4329

Design

emergenza / emergency



Caratteristiche

Installazioni Parete, plafone, incasso, bandiera

Corpo PHA bianco RAL 9003

Ottica Simmetrica, bianca

Schermo Policarbonato trasparente

Conformità EN 60598-1, EN 60598-2-2, EN 60598-2-22, UNI EN 1838, UNI 11222, EN 62034

Applicazioni

Terziario e civile, anche in situazioni di design dove è richiesta particolare cura nel ridurre l'impatto estetico dell'illuminazione di emergenza.

Characteristics

Mounting Wall, ceiling, recessed, edge mounting

Housing PHA white RAL 9003

Optics Symmetrical, white

Screen Clear polycarbonate

Compliance EN 60598-1, EN 60598-2-2, EN 60598-2-22, UNI EN 1838, UNI 11222, EN 62034

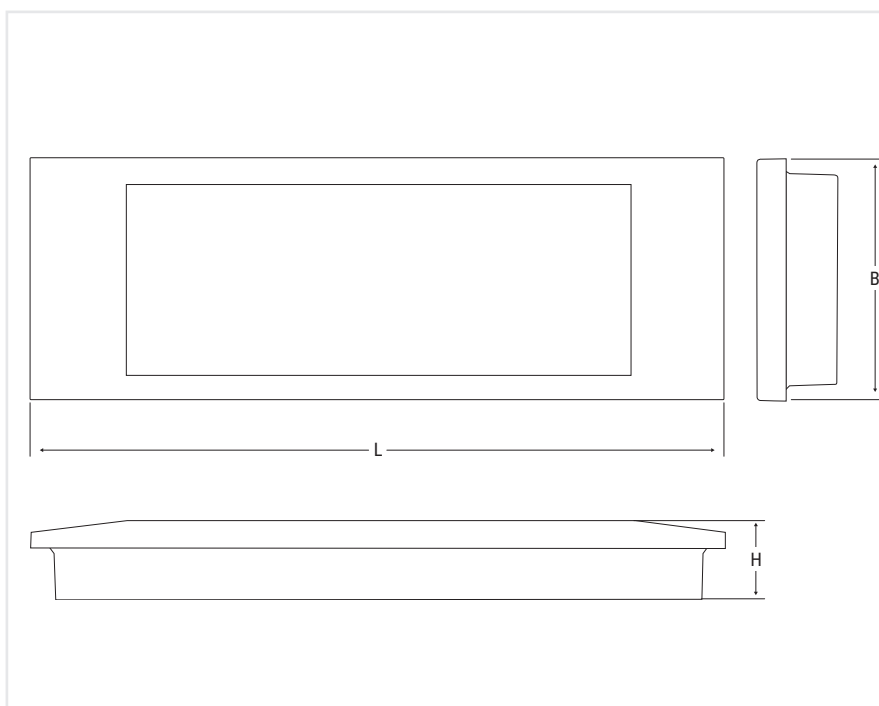

Applications

Service sectors and residential, even in design situations where special care is required to reduce the aesthetic impact of emergency lighting.



Dimensioni Dimensions mm			Distanza di visibilità Distance of visibility (DV)	
L	B	H	Parete Wall	Bandiera Edge mounting
292	102	34.6	15 m	20 m

Prestazioni secondo EN 1838 / Performance according to EN 1838

Altezza apparecchio Height 	Interasse fra gli apparecchi Centre distance VIE DI ESODO - ESCAPE ROUTES 		Area illuminata da ogni apparecchio Illuminated surface area GRANDI AREE / LARGE AREAS 	
	(m)	Parete / Wall (m)	Plafone / Ceiling (m)	Parete / Wall (m)
2.5	6	-	3x5	-
3	-	11	-	6x6

illuminamento >1lx a pavimento lungo la linea centrale senza riflessioni Emax/Emin <40 <i>lighting >1lx at floor level along the centre line without reflection Emax/Emin <40</i>	illuminamento >0,5lx a pavimento senza riflessioni Emax/Emin <40 <i>lighting >0,5lx at floor level without reflections Emax/Emin <40</i>
--	---

DESIGN

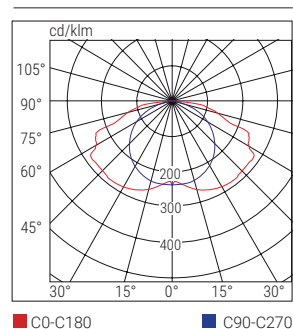

■ C0-C180 ■ C90-C270

Prestazioni riferite all'apparecchio Cod. 4293A 225 lm
Performance with reference to luminaire Cod. 4293A 225 lm

Coefficiente di manutenzione 0,8
Maintenance coefficient 0,8

	Cod.	W eq.	Descrizione Description	Versione Version	Autonomia Autonomy h	Flusso Flux SE lm	Flusso Flux SA lm	Assorbimento Absorbed Power	
								DC	AC
TR	4290A	8	DESIGN AE 8W SE 1H IP40	SE	1	120	-	1W	
	4291A	11	DESIGN AE 11W SE 1H IP40	SE	1	140	-	1W	
	4292A	11	DESIGN AE 11W SE/SA 1H IP40	SE/SA	1	140	90	2.5W	
	4293A	24	DESIGN AE 24W SE 1H IP40	SE	1	225	-	1W	

ACCESSORI - da ordinare separatamente / ACCESSORIES - to be ordered separately



**SCHERMI SX/DX/BASSO
LH/RH/DOWN SCREENS**
Serigrafia su policarbonato opale
Screen print on opal polycarbonate

Cod. 4269



**STAFFA CONTROSOFFITTO
FALSE CEILING BRACKET**
Foro incasso: 279x94 mm
Recessed mounting hole: 279x94 mm

Cod. 4266



**ADESIVI SX/DX/BASSO
LH/RH/DOWN STICKERS**

Cod. 4278



**STAFFA PARETE PER BANDIERA
WALL BRACKET FOR EDGE MOUNTING**

Cod. 4265



**SCHERMI BANDIERA
EDGE MOUNTED SCREENS**
Serigrafia su policarbonato trasparente
Screen print on clear polycarbonate

Cod. 4268 (BASSO/DOWN) Cod. 4267 (SX-DX/LH-RH)



**SCATOLA DA INCASSO 3106/IP
RECESS MOUNTING BOX 3106/IP**

Cod. 3733



Caratteristiche

Installazioni Incasso

Corpo PHA bianco RAL 9003

Optica In PMMA

Conformità EN 60598-1, EN 60598-2-2, EN 60598-2-22, UNI EN 1838, UNI 11222, EN 62034

Applicazioni

Terziario, uffici, cinema, hotel, musei scuole, negozi, centri commerciali, show room di design

Characteristics

Mounting Recessed

Housing PHA white RAL 9003

Optics PMMA

Compliance EN 60598-1, EN 60598-2-2, EN 60598-2-22, UNI EN 1838, UNI 11222, EN 62034

Applications

Service sectors, offices, cinemas, hotels, museums, schools, shops, shopping centres, design rooms

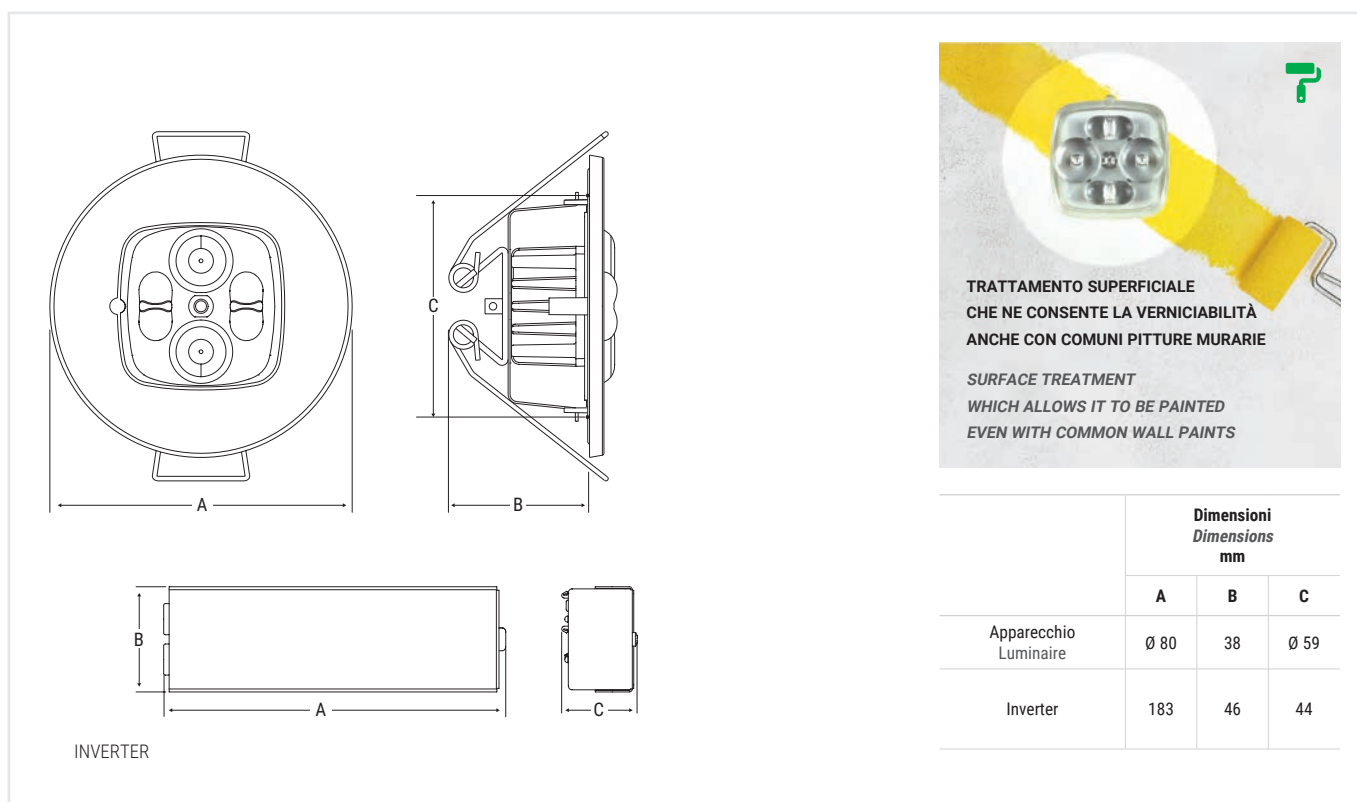

Prestazioni secondo EN 1838 / Performance according to EN 1838

Lente Lens	Altezza apparecchio Height	Interasse fra gli apparecchi Centre distance VIE DI ESODO - ESCAPE ROUTES		Area illuminata da ogni apparecchio Illuminated surface area GRANDI AREE / LARGE AREAS	
	(m)	Parete / Wall (m)	Plafone / Ceiling (m)	Parete / Wall (m)	Plafone / Ceiling (m)
Lungaluce	3	-	30	-	-
Largaluce	3	-	-	-	14x16
Altaluce	7	-	12	-	10x6
		illuminamento >1lx a pavimento lungo la linea centrale senza riflessioni Emax/Emin <40 lighting >1lx at floor level along the centre line without reflection Emax/Emin <40		illuminamento >0,5lx a pavimento senza riflessioni Emax/Emin <40 lighting >0,5lx at floor level without reflections Emax/Emin <40	

Prestazioni riferite all'apparecchio Cod. 19714 1000lm
Performance with reference to luminaire Cod. 19714 1000lm

Coefficiente di manutenzione 0.8
Maintenance coefficient 0.8

LUNGALUCE

80%

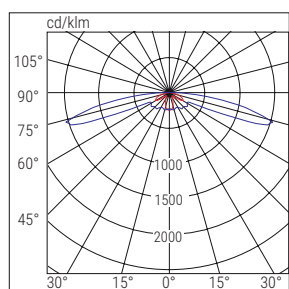

■ C90-C270 ■ C0-C180

LARGALUCE

91%

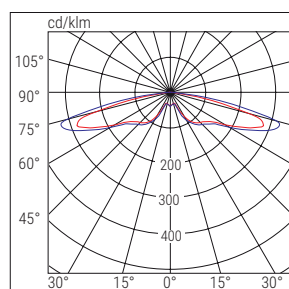

■ C0-C180 ■ C90-C270

ALTALUCE

90%

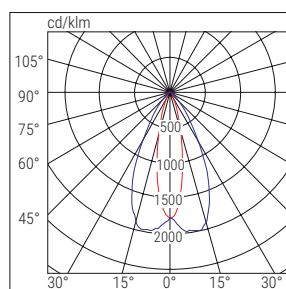

■ C0-C180 ■ C90-C270

ASIMMETRICA

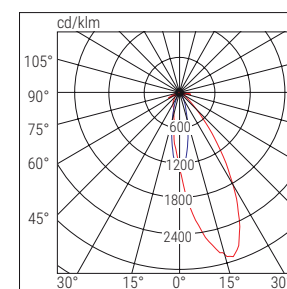

90%

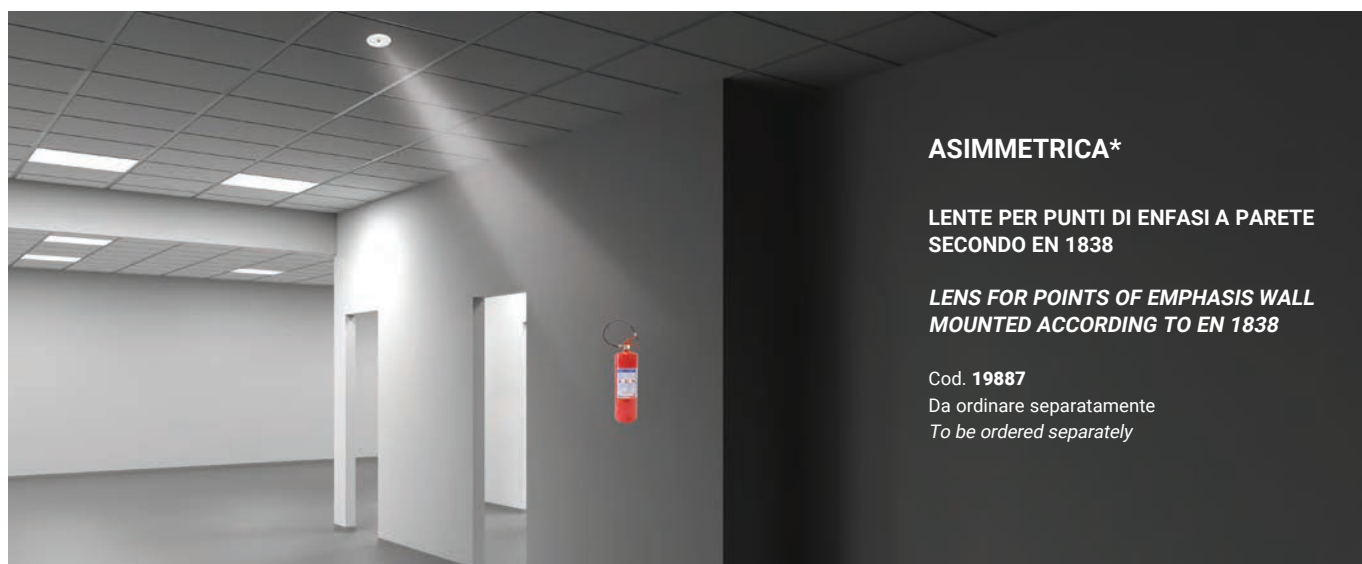

■ C0-C180 ■ C90-C270

LENTE ACCESSORIA - da ordinare separatamente



	Cod. ord.	W eq.	Descrizione Description	Versione Version	Autonomia Autonomy h	Flusso Flux SE lm	Flusso Flux SA lm	Assorbimento Absorbed Power		Note Notes
								DC	AC	
TR	19700	24GL	DOT AE SE/SA 1/2/3H IP65 RM	SE/SA	1/2/3	550/300/200	240		2 W	
CT	19711	24GL	DOT AE CT SE/SA LF IP65	SE/SA/PS	1/1.5/2/3/8	550/380/300/200/100	240		5 W	
	19712	36GL	DOT AE GL CT SE/SA IP65 LF	SE/SA/PS	1/1.5/2/3/8	1000/700/550/400/150	240		5 W	
<p>Gli apparecchi CT possono integrare dispositivi opzionali per l'espansione ad altri sistemi: Modulo LG cod.15079 - Modulo LGFM Cod.15037 - Modulo DALI cod.15080 <i>The CT luminaires can integrate optional devices for expansion to other systems: LG Module cod.15036 - LGFM Module cod.15037 - DALI Module cod.15038</i></p>										
CTS	LG230									
	17880	24GL	DOT AE LG230 IP65	SE/SA		550	550	4.7 W	9.4 VA	
	LG24									
	17881	24GL	DOT AE LG24 IP65 LS-UV	SE/SA		550	550	4.1 W		
HT	LG EPS									
	31309	24	DOT AE LG EPS IP65	SE/SA		550	550		9.4 VA	
HT	HT230									
	17882	24GL	DOT AE HT IP65	HT		550	550	4.6 W	9.1 VA	

ACCESSORI - da ordinare separatamente / ACCESSORIES - to be ordered separately



TELECOMANDO INIBIT RM
RM INIBIT REMOTE CONTROL
 Solo apparecchi TR e AT equipaggiati di modulo RM
Only TR and AT devices equipped with RM module
 Cod. **2730** RM



MODULO / MODULE LG - LGFM - DALI
 Solo per apparecchi CT / CT version only

LG - Cod. **15079**

LGFM - Cod. **15037**

DALI - Cod. **15038**

LG

LGFM

DALI



Design Flag

emergenza / emergency



Caratteristiche

Installazioni Parete, plafone

Corpo Alluminio estruso bianco RAL 9003

Diffusore Policarbonato trasparente

Conformità EN 60598-1, EN 60598-2-22, UNI EN 1838, UNI 11222, EN 62034

Applicazioni

Terziario, uffici, cinema, hotel, centri commerciali, musei, negozi, show room di design

Characteristics

Mounting Wall, ceiling

Housing Extruded aluminium white RAL 9003

Diffuser Transparent polycarbonate



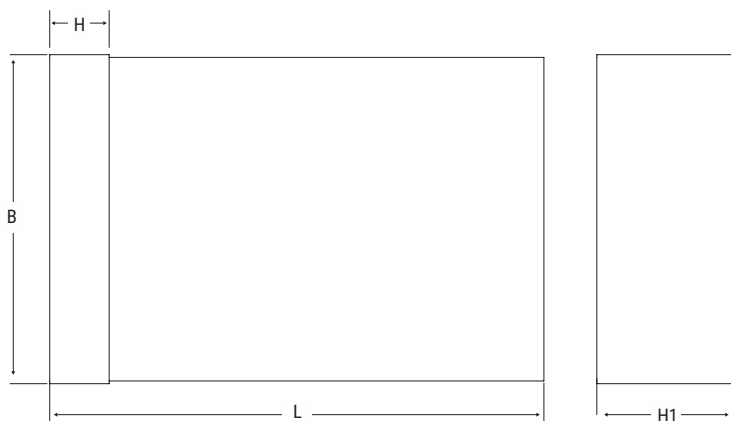

Compliance EN 60598-1, EN 60598-2-22, UNI EN 1838, UNI 11222, EN 62034

Applications

service sectors, offices, cinemas, hotels, shopping centres, museums, shops, design showrooms



Dimensioni Dimensions mm				Distanza di visibilità Distance of visibility (DV)
L	B	H	H1	
274	183	33	78	36m

	Cod.	Descrizione Description	Versione Version	Autonomia Autonomy h	Distanza visibilità Distance of visibility DV	Flusso Flux SE lm	Flusso Flux SA lm	Assorbimento Absorbed Power		Note Notes	
								DC	AC		
TR	18400	DESIGN FLAG SX SE/SA TR RM	SE/SA	1/2/3	36m				3W		
	18402	DESIGN FLAG DX SE/SA TR RM	SE/SA	1/2/3	36m				3W		
	18403	DESIGN FLAG BASSO SE/SA TR RM	SE/SA	1/2/3	36m				3W		
	18404	FLAG ALTO SE/SA TR RM	SE/SA	1/2/3	36m				3W		
AT	19819	DESIGN FLAG SX SE/SA AT LF	SE/SA/PS	1/1.5/2/3/8	36m				5W		
	19820	DESIGN FLAG DX SE/SA AT LF	SE/SA/PS	1/1.5/2/3/8	36m				5W		
	19821	DESIGN FLAG BASSO SE/SA AT LF	SE/SA/PS	1/1.5/2/3/8	36m				5W		
	19822	DESIGN FLAG ALTO SE/SA AT LF	SE/SA/PS	1/1.5/2/3/8	36m				5W		
CT	18401	DESIGN FLAG SX SE/SA CT LF	SE/SA/PS	1/1.5/2/3/8	36m				5W		
	18405	DESIGN FLAG DX SE/SA CT LF	SE/SA/PS	1/1.5/2/3/8	36m				5W		
	18406	DESIGN FLAG BASSO SE/SA CT LF	SE/SA/PS	1/1.5/2/3/8	36m				5W		
	18407	DESIGN FLAG ALTO SE/SA CT LF	SE/SA/PS	1/1.5/2/3/8	36m				5W		
<p>Gli apparecchi CT possono integrare dispositivi opzionali per l'espansione ad altri sistemi: Modulo LG cod.15036 - Modulo LGFM Cod.15037 - Modulo DALI cod.15038 The CT luminaires can integrate optional devices for expansion to other systems: LG Module cod.15036 - LGFM Module cod.15037 - DALI Module cod.15038</p>											
CTS	LG230										
	17908	DESIGN FLAG SX LGS230	SE/SA		36m				2.6W	6.1VA	
	17930	DESIGN FLAG DX LGS230	SE/SA		36m				2.6W	6.1VA	
	17931	DESIGN FLAG BASSO LGS230	SE/SA		36m				2.6W	6.1VA	
	17932	DESIGN FLAG ALTO LGS230	SE/SA		36m				2.6W	6.1VA	
	LG24										
	17909	DESIGN FLAG SX LGS24	SE/SA		36m				2.5W		
	17933	DESIGN FLAG DX LGS24	SE/SA		36m				2.5W		
	17934	DESIGN FLAG BASSO LGS24	SE/SA		36m				2.5W		
	17935	DESIGN FLAG ALTO LGS24	SE/SA		36m				2.5W		
HT	HT230										
	17910	DESIGN FLAG SX HT	HT		36m				3.1W	6.6VA	
	17936	DESIGN FLAG DX HT	HT		36m				3.1W	6.6VA	
	17937	DESIGN FLAG BASSO HT	HT		36m				3.1W	6.6VA	
17938	DESIGN FLAG ALTO HT	HT		36m				3.1W	6.6VA		

ACCESSORI - da ordinare separatamente / ACCESSORIES - to be ordered separately



MODULO / MODULE LG - LGFM - DALI
Solo per apparecchi CT / CT version only

LG - Cod. **15036**

LGFM IP65 - Cod. **15049**

DALI - Cod. **15038**

LG

LGFM

DALI



TELECOMANDO INIBIT RM
RM INIBIT REMOTE CONTROL

Solo apparecchi TR e AT equipaggiati di modulo RM
Only TR and AT devices equipped with RM module

Cod. **2730**

RM



WEB
CATALOGUE



IP40

IK05

850°



+40°C
0°C

Caratteristiche

Installazioni incasso (scatola 506)

Corpo Policarbonato

Ottica PC, asimmetrica, metallizzata

Schermo Policarbonato trasparente

Conformità EN 60598-1, EN 60598-2-2, EN 60598-2-22, UNI EN 1838, UNI 11222, EN 62034

Applicazioni

Civile e terziario, sia illuminazione di emergenza che segnapasso o lampada notturna

Characteristics

Mounting recessed (box 506)

Housing Polycarbonate

Optics PC, asymmetrical, metallic

Screen Clear polycarbonate

Compliance EN 60598-1, EN 60598-2-2, EN 60598-2-22, UNI EN 1838, UNI 11222, EN 62034

Applications

Residential and service sectors, either emergency lighting or night lighting, as well as steplight

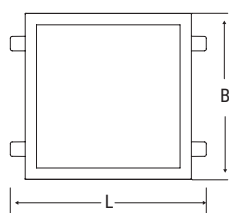

TUTTIFRUTTI 2

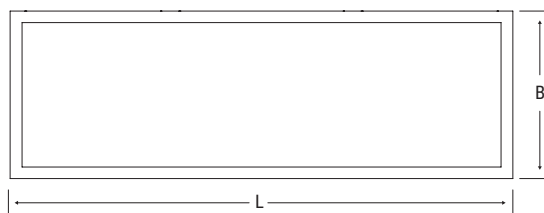

TUTTIFRUTTI 6

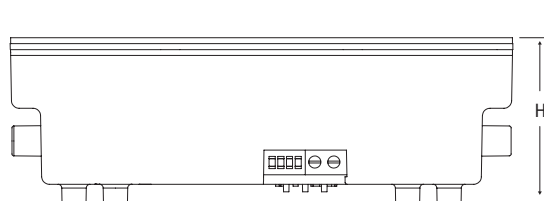
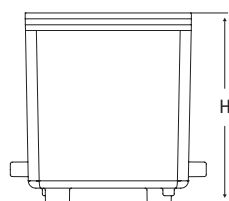

Versione Version	Dimensioni Dimensions mm		
	L	B	H
TUTTI FRUTTI 2	52	44	54
TUTTI FRUTTI 6	132	44	44

TUTTI FRUTTI 2

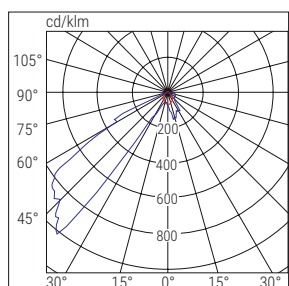
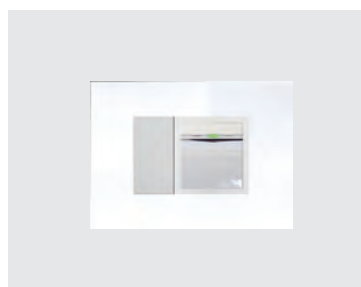

■ C90-C270 ■ C0-C180

TUTTI FRUTTI 6

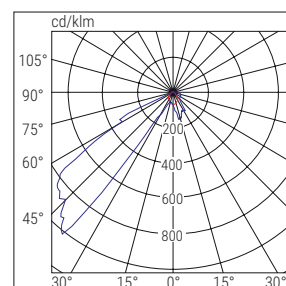

■ C90-C270 ■ C0-C180

	Cod.	Descrizione Description	Versione Version	Autonomia Autonomy h	Flusso Flux SE lm	Flusso Flux SA lm	Assorbimento Absorbed Power	
							DC	AC
TR	TUTTI FRUTTI 2							
	4607	TUTTIFRUTTI 2-3 LED SE 2h	SE	2	30			0.7W
TR	TUTTI FRUTTI 6							
	4609	TUTTIFRUTTI 6 LED SE 2h	SE	2	70			0.7W



Fruttoluca

emergenza / emergency



IP40

IK05

850°



+40°C
0°C

Caratteristiche

Installazioni Parete come segnapasso, parete come lampada notturna, Parete come illuminazione di emergenza

Corpo Policarbonato

Ottica Asimmetrica, metallizzata

Schermo Policarbonato trasparente

Conformità EN 60598-1, EN 60598-2-2, EN 60598-2-22, UNI EN 1838, UNI 11222, EN 62034

Applicazioni

Terziario e civile, per illuminazione di emergenza che segnapasso o lampada notturna

Characteristics

Mounting Wall as steplight, wall as night light, wall as emergency lighting

Housing Polycarbonate

Optics Asymmetrical, metallic

Screen Clear polycarbonate

Compliance EN 60598-1, EN 60598-2-2, EN 60598-2-22, UNI EN 1838, UNI 11222, EN 62034

Applications

Service sectors and residential, for emergency lighting or night lighting and as steplight

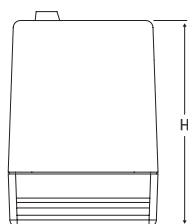
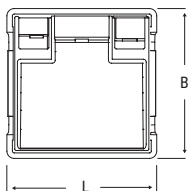

FRUTTOLUCE 1-2

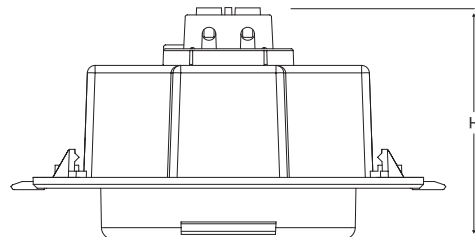
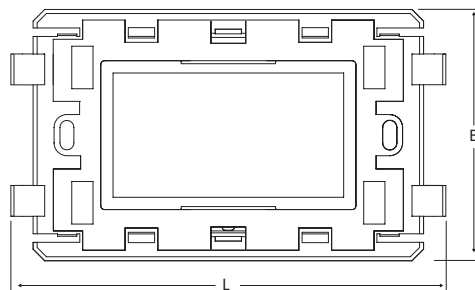

FRUTTOLUCE 3-6

Versione Version	Dimensioni Dimensions mm		
	L	B	H
FRUTTOLUCE 1	19	41	56.5
FRUTTOLUCE 2	41	41	56.5
FRUTTOLUCE 3	112	65	60
FRUTTOLUCE 6	187	70	40

FRUTTOLUCE 1

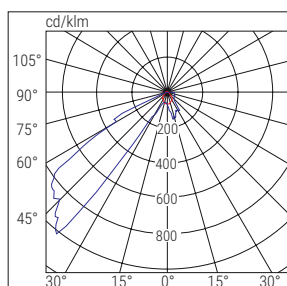
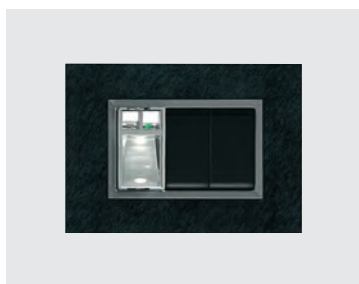

■ C90-C270 ■ C0-C180

FRUTTOLUCE 2

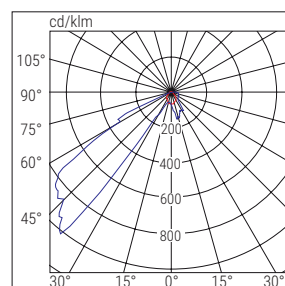
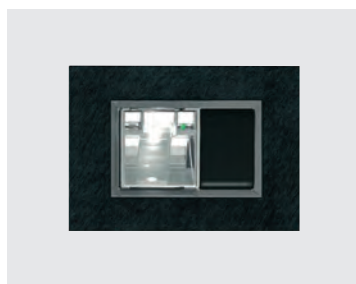

■ C90-C270 ■ C0-C180

FRUTTOLUCE 3

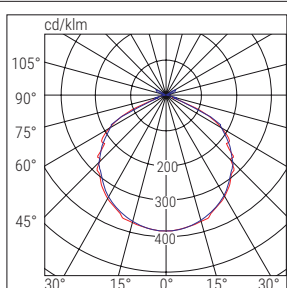
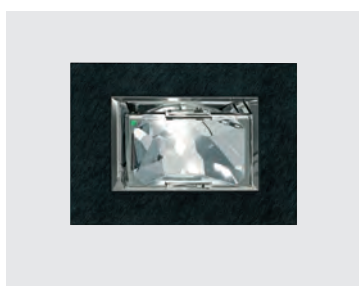

■ C0-C180 ■ C90-C270

FRUTTOLUCE 6

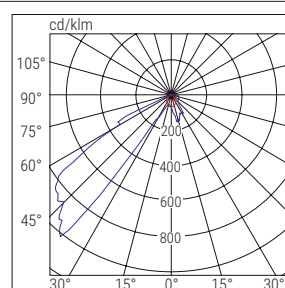

■ C90-C270 ■ C0-C180

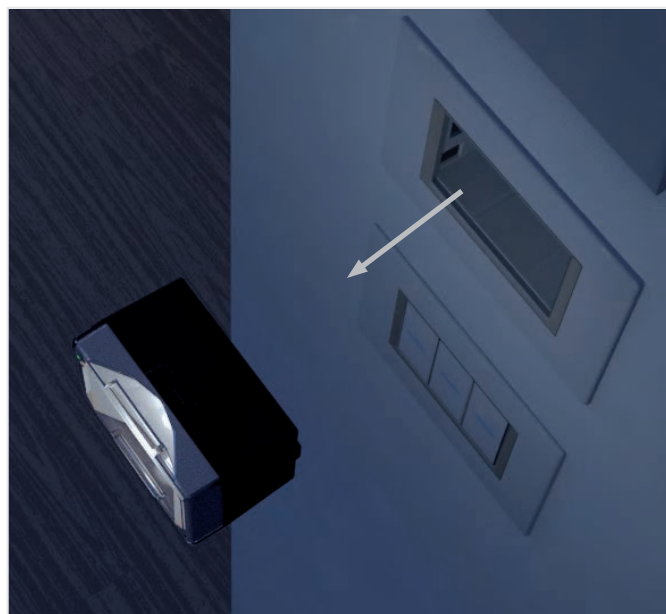

FRUTTOLUCE 3

TORCIA ESTRAIBILE PER UTILIZZO DOMESTICO
EXTRACTABLE TORCH FOR DOMESTIC USE

FruttoLuce3 può essere comodamente estratta dall'installazione per portare la luce dove serve. Il sistema di sbloccaggio facilita l'estrazione della torcia garantendo la massima sicurezza della morsettiera di alimentazione.

FruttoLuce3 can be conveniently removed from the mount to bring light where it is needed. The unlocking system facilitates the extraction of the torch while ensuring a maximum safety of the power supply terminal block.

	Cod.	Descrizione Description	Versione Version	Autonomia Autonomy h	Flusso Flux SE lm	Flusso Flux SA lm	Assorbimento Absorbed Power	
							DC	AC
TR	FRUTTOLUCE 1							
	4601	FRUTTOLUCE1 LED SE/SA 1N	SE/SA	1				0.5W
	FRUTTOLUCE 2							
	4602	FRUTTOLUCE2 LED SE/SA 1N	SE/SA	1				0.8W
	FRUTTOLUCE 3							
4603	FRUTTOLUCE3 LED SE/SA 1N	SE/SA	1				0.4W	
FRUTTOLUCE 6								
4605	FRUTTOLUCE6 LED 4605-SE/SA 1N	SE/SA	1				1W	

Linea 500

emergenza / emergency



IP40

IK05

850°



+40°C
0°C

Caratteristiche

Installazione Incasso

Corpo Policarbonato

Ottica Simmetrica, metallizzata

Schermo Policarbonato trasparente

Placca Policarbonato RAL 9003

Conformità EN 60598-1, EN 60598-2-2, EN 60598-2-22, UNI EN 1838, UNI 11222, EN 62034

Applicazioni

Civile e Terziario anche in locali adibiti al Pubblico spettacolo

Characteristics

Mounting Recessed

Housing Polycarbonate

Optics Symmetrical, metallic

Screen Clear polycarbonate

Plate Polycarbonate, RAL 9003

Compliance EN 60598-1, EN 60598-2-2, EN 60598-2-22, UNI EN 1838, UNI 11222, EN 62034

Applications

Residential and service sectors, also in premises used for public entertainment

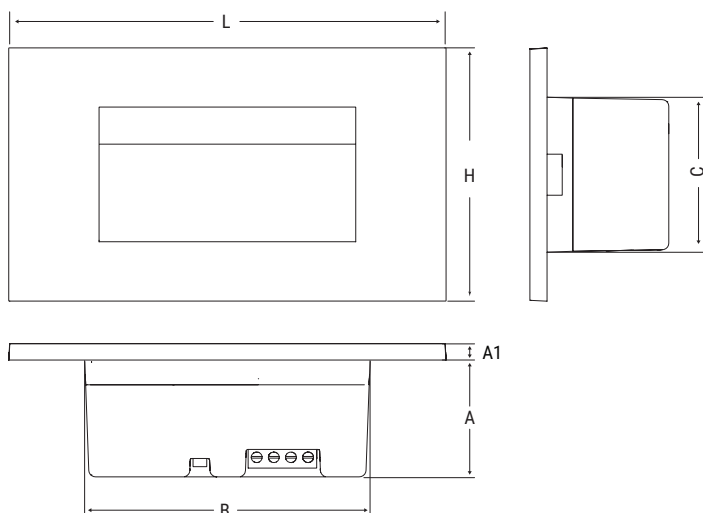

Versione Version	Dimensioni Dimensions mm					
	L	H	B	A	A1	C
LINEA 503	118	76	78	36	5	49
LINEA 506	209	76	164	35	5	47

LINEA 503

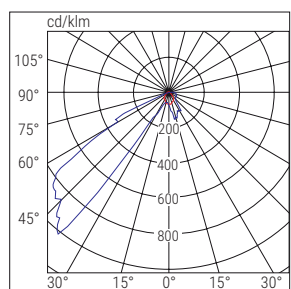

■ C90-C270 ■ C0-C180

LINEA506

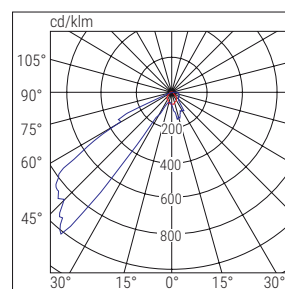

■ C90-C270 ■ C0-C180

	Cod.	Descrizione Description	Versione Version	Autonomia Autonomy h	Flusso Flux SE lm	Flusso Flux SA lm	Assorbimento Absorbed Power	
							DC	AC
TR	LINEA 503							
	4611	LINEA 503 LED SE 2h	SE	2	60			0.8W
TR	LINEA 506							
	4612	LINEA 506 LED SE 1h	SE	1	40			0.8W

ACCESSORI - in dotazione / ACCESSORIES - included

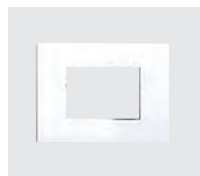

PLACCA COPRIFORO
HOLE COVER PLATE



Placca Brain Classic Emergenza

emergenza / emergency



Caratteristiche

Installazioni Su scatola 503

Corpo Policarbonato, bianco RAL 9003

Diffusore In PMMA

Conformità EN 60598-1, EN 60598-2-22

Applicazioni

Civile, terziario, hotel di lusso, show room, ristoranti di design

Characteristics

Mounting On box 503

Housing Polycarbonate, white RAL 9003

Diffuser PMMA

Compliance EN 60598-1, EN 60598-2-22

Applications

Residential, service sectors, luxury hotels, showrooms, designer restaurants



IP20

IK05

850°



15 Colori RGB impostabili



+40°C
0°C

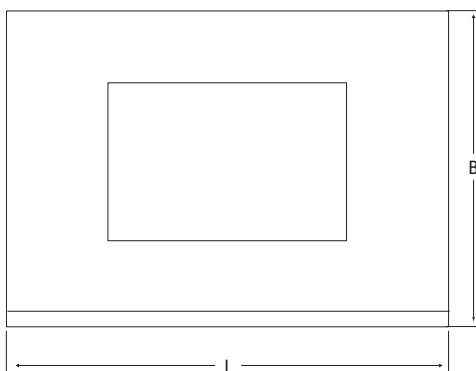

PLACCA PER SCATOLA 503 / PLACCA PER SCATOLA 503

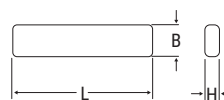

BATTERIA PER ILLUMINAZIONE DI EMERGENZA
BATTERY FOR EMERGENCY LIGHTING

	Dimensioni Dimensions mm		
	L	B	H
PLACCA / PLATE	126	90	12
BATTERIA / BATTERY	45	9	6

LUCE NOTTURNA / NIGHT LIGHT

Sensore di luce con modalità di colore e intensità a scelta, differenziate fra giorno e notte. / Light sensor with selectable colour and intensity modes, differentiated for day and night.



COMPATIBILITÀ CON LE SERIE CIVILI PIÙ DIFFUSE

COMPATIBILITY WITH THE MOST POPULAR RESIDENTIAL SERIES

BTicino Axolute - Axolute Air - Light - Living Light - Living Light AIR - Living International - **Vimar** Plana - Arkè Eikon - EVO - **Gewiss** Chorus - **AVE** Sistema 44 - **ABB** Chiara - Mylos.

I marchi sono registrati dai rispettivi titolari. Le serie citate, dispongono delle rispettive placche originali.

The trademarks mentioned in the table are registered trademarks of their respective owners. The luminaire series mentioned, have their own original plates.

	Cod.	Descrizione Description	Versione Version	Autonomia Autonomy h	Flusso Flux SE lm	Flusso Flux SA lm	Assorbimento Absorbed Power	
							DC	AC
TR	81143	PLACCA BRAIN CLASSIC EM 3F BIANCA	SE/SA	1				1.5W

ACCESSORI - in dotazione / ACCESSORIES - included



BATTERIA CLASSIC
CLASSIC BATTERY

Cod. 81296E

TR

TR



SERIE DI ADATTATORI
ADAPTER SERIES

Per installazioni in tutte le serie civili più diffuse
For mounting in all common residential series

ACCESSORI - da ordinare separatamente / ACCESSORIES - to be ordered separately



ADATTATORI SPECIALI/ SPECIAL ADAPTERS

Per serie BTicino Matix, Living 1a serie, Vimar Idea
For BTicino Matix series, Living 1st series, Vimar Idea

Cod. 81236 (bianco / white)
Cod. 81237 (nero / black)



Ironflag IP65

emergenza / emergency



Caratteristiche

Installazioni Parete, plafone, sopraporta

Corpo Alluminio non verniciato

Schermo Policarbonato trasparente

Conformità EN 60598-1, EN 60598-2-2, EN 60598-2-22, UNI EN 1838, UNI 11222, EN 62034

Applicazioni

Industriale, terziario, hotel, ospedali, scuole, uffici, attività commerciali

Characteristics

Mounting Wall, ceiling, overhead

Housing Unpainted aluminium

Screen Clear polycarbonate

Compliance EN 60598-1, EN 60598-2-2, EN 60598-2-22, UNI EN 1838, UNI 11222, EN 62034

Applications

Industry, service sectors, hotels, hospitals, schools, office, commercial activities

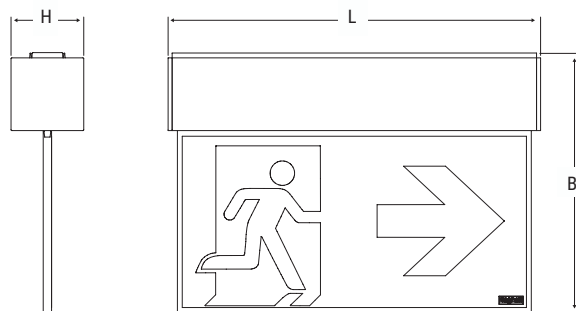

Dimensioni Dimensions mm			Distanza di visibilità Distance of visibility (DV)
L	B	H	
353	223	60	30 m

	Cod.	Descrizione Description	Versione Version	Autonomia Autonomy h	Distanza visibilità Distance of visibility DV	Assorbimento Absorbed Power		Note
						DC	AC	
TR	4383	IRONFLAG IP65 30M SA RM	SE/SA	1/2/3	30m		3W	
AT	19818	IRONFLAG IP65 AT 30M SA	SE/SA/PS	1/1.5/2/3/8	30m		5W	
CT	4384	IRONFLAG IP65 CT 30M SA	SE/SA/PS	1/1.5/2/3/8	30m		5W	
<p>Gli apparecchi CT possono integrare dispositivi opzionali per l'espansione ad altri sistemi: Modulo LG cod.15036 - Modulo LGFM Cod.15037 - Modulo DALI cod.15038 The CT luminaires can integrate optional devices for expansion to other systems: LG Module cod.15036 - LGFM Module cod.15037 - DALI Module cod.15038</p>								
LG230								
CTS	17924	IRONFLAG IP65 LG230 30M	SE/SA		30m	4.1W	8.3VA	
	LG24							
	17925	IRONFLAG IP65 LG24 30M	SE/SA		30m	3.7W		
LG EPS								
	31322	IRON FLAG IP65 LG EPS DALI	SE/SA		30m		8.3VA	
HT230								
HT	17926	IRONFLAG IP65 HT 30M	HT		30m	4.7W	9.5VA	

ACCESSORI - in dotazione / ACCESSORIES - included



**SCHERMI SX/DX/BASSO
LH/RH/DOWN SCREENS**
Serigrafia su policarbonato opale
Screen print on opal polycarbonate

Cod. **4269**

ACCESSORI - da ordinare separatamente / ACCESSORIES - to be ordered separately



MODULO / MODULE LG - LGFM - DALI
Solo per apparecchi CT / CT version only

LG - Cod. **15036**
LGFM IP65 - Cod. **15049**
DALI - Cod. **15038**

LG

LGFM

DALI



**TELECOMANDO INIBIT RM
RM INIBIT REMOTE CONTROL**

Solo apparecchi TR e AT equipaggiati di modulo RM
Only TR and AT devices equipped with RM module

Cod. **2730**

RM



MODULO RM / RM MODULE
Rest Mode RM solo per apparecchi AT
Rest Mode RM only for AT devices

Cod. **15048**

AT



SCHERMI ALTO / UP SCREENS
Serigrafia su policarbonato opale
Screen print on opal polycarbonate

30m - Cod. **4665**

AT

Ironflag

emergenza / emergency



Caratteristiche

Installazioni Parete, plafone, incasso, sospensione e sopraporta

Corpo Alluminio non verniciato

Schermo Policarbonato trasparente

Conformità EN 60598-1, EN 60598-2-2, EN 60598-2-22, UNI EN 1838, UNI 11222, EN 62034

Applicazioni

Terziario, hotel, ospedali, scuole, uffici, attività commerciali

Characteristics

Mounting Wall, ceiling, recessed, suspended and above door

Housing Unpainted aluminium

Screen Clear polycarbonate

Compliance EN 60598-1, EN 60598-2-2, EN 60598-2-22, UNI EN 1838, UNI 11222, EN 62034

Applications

Service sectors, hotels, hospitals, schools, offices, commercial activities

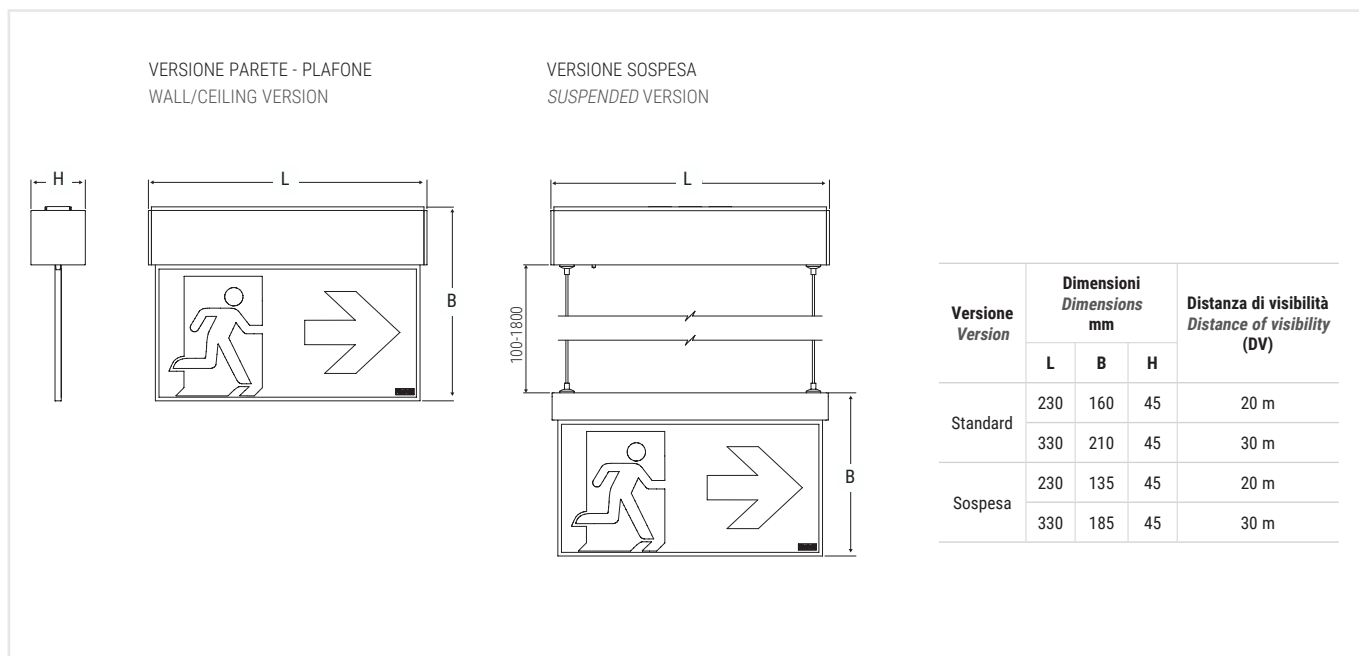

	Installazione Version	Cod.	Descrizione Description	Versione Version	Autonomia Autonomy h	Distanza visibilità Distance of visibility DV	Assorbimento Absorbed Power		Note Notes
							DC	AC	
TR	Parete - plafone Wall - ceiling	19800	IRONFLAG 20M SA RM	SE/SA	1/2/3	20m		3W	
	Parete - plafone Wall - ceiling	19801	IRONFLAG 30M SA RM	SE/SA	1/2/3	30m		3W	
	Sospesa Suspended	19802	IRONFLAG PEND 20M SA RM	SE/SA	1/2/3	20m		3W	
	Sospesa Suspended	19803	IRONFLAG PEND 30M SA RM	SE/SA	1/2/3	30m		3W	
AT	Parete - plafone Wall - ceiling	19814	IRONFLAG AT 20M SA	SE/SA/PS	1/1.5/2/3/8	20m		5W	
	Parete - plafone Wall - ceiling	19815	IRONFLAG AT 30M SA	SE/SA/PS	1/1.5/2/3/8	30m		5W	
	Sospesa Suspended	19816	IRONFL PEND AT 20M SA	SE/SA/PS	1/1.5/2/3/8	20m		5W	
	Sospesa Suspended	19817	IRONFL PEND AT 30M SA	SE/SA/PS	1/1.5/2/3/8	30m		5W	
CT	Parete - plafone Wall - ceiling	19810	IRONFLAG CT 20M SA	SE/SA/PS	1/1.5/2/3/8	20m		5W	
	Parete - plafone Wall - ceiling	19811	IRONFLAG CT 30M SA	SE/SA/PS	1/1.5/2/3/8	30m		5W	
	Sospesa Suspended	19812	IRONFL PEND CT 20M SA	SE/SA/PS	1/1.5/2/3/8	20m		5W	
	Sospesa Suspended	19813	IRONFL PEND CT 30M SA	SE/SA/PS	1/1.5/2/3/8	30m		5W	
<p>Gli apparecchi CT possono integrare dispositivi opzionali per l'espansione ad altri sistemi: Modulo LG cod.15036 - Modulo LGFM Cod.15037 - Modulo DALI cod.15038 The CT luminaires can integrate optional devices for expansion to other systems: LG Module cod.15036 - LGFM Module cod.15037 - DALI Module cod.15038</p>									
LG230									
CTS	Parete - plafone Wall - ceiling	17890	IRONFLAG LG230 20M	SE/SA		20m	2.6W	6.1VA	
	Parete - plafone Wall - ceiling	17891	IRONFLAG IP65 LG24 30M	SE/SA		30m	4.1W	8.3VA	
	Sospesa Suspended	17892	IRONFLAG PEND LG230 20M	SE/SA		20m	2.6W	6.1VA	
	Sospesa Suspended	17893	IRONFLAG PEND LG230 30M	SE/SA		30m	4.1W	8.3VA	
LG24									
CTS	Parete - plafone Wall - ceiling	17894	IRONFLAG LG24 20M	SE/SA		20m	2.5W		
	Parete - plafone Wall - ceiling	17895	IRONFLAG LG24 30M	SE/SA		30m	3.7W		
	Sospesa Suspended	17896	IRONFLAG PEND LG24 20M	SE/SA		20m	2.5W		
	Sospesa Suspended	17897	IRONFLAG PEND LG24 30M	SE/SA		30m	3.7W		
LG EPS									
CTS	Parete - plafone Wall - ceiling	31318	IRONFLAG LG EPS DALI 20M	SE/SA		20m		6.1VA	
	Parete - plafone Wall - ceiling	31319	IRONFLAG LG EPS DALI 30M	SE/SA		30m		8.3VA	
	Sospesa Suspended	31320	IRONFLAG PEND LG EPS DALI 20M	SE/SA		20m		6.1VA	
	Sospesa Suspended	31321	IRONFLAG PEND LG EPS DALI 30M	SE/SA		30m		8.3VA	
HT230									
HT	Parete - plafone Wall - ceiling	17898	IRONFLAG HT 20M	HT		20m	3.1W	6.6VA	
	Parete - plafone Wall - ceiling	17899	IRONFLAG HT 30M	HT		30m	4.7W	9.5VA	
	Sospesa Suspended	17900	IRONFLAG PEND HT 20M	HT		20m	3.1W	6.6VA	
	Sospesa Suspended	17901	IRONFLAG PEND HT 30M	HT		30m	4.7W	9.5VA	

SEGUE / NEXT >

Ironflag

ACCESSORI - in dotazione / ACCESSORIES - included



CAVI DI SOSPENSIONE
SUSPENDED MOUNTING CABLES
Solo versione SOSPESA
SUSPENDED version only



SCHERMI SX/DX/BASSO
LH/RH/DOWN SCREENS
Serigrafia su policarbonato opale
Screen print on opal polycarbonate

ACCESSORI - da ordinare separatamente / ACCESSORIES - to be ordered separately



MODULO / MODULE LG - LGFM - DALI
Solo per apparecchi CT / *CT version only*

LG - Cod. **15036**
LGFM IP65 - Cod. **15049**
DALI - Cod. **15038**

LG
LGFM
DALI



TELECOMANDO INIBIT RM
RM INIBIT REMOTE CONTROL
Solo apparecchi TR e AT equipaggiati di modulo RM
Only TR and AT devices equipped with RM module

Cod. **2730**

RM



KIT INCASSO / RECESSED MOUNTING KIT

Plafone / Ceiling:
20m - Cod. **19880**, **30m** - Cod. **19881**
Sospensione / Suspended:
20m - Cod. **19885**, **30m** - Cod. **19886**



SCHERMI ALTO / UP SCREENS
Serigrafia su policarbonato opale
Screen print on opal polycarbonate

30m - Cod. **4665**

AT



131 segnaletica / exit sign



Caratteristiche

Installazioni parete, controsoffitto, soffitto con tiges e cavi, parete bandiera, soffitto bandiera, binario trifase

Corpo Policarbonato, bianco RAL 9003

Schermo Policarbonato trasparente

Conformità EN 60598-1, EN 60598-2-22, UNI EN 1838, UNI 11222, EN 62034

Applicazioni

Terziario, industriale

Characteristics

Mounting Wall, false ceiling, ceiling with rods and cables, edge mounting on wall, edge mounting on ceiling, three-phase track

Housing Polycarbonate, white RAL 9003

Screen Clear polycarbonate

Compliance EN 60598-1, EN 60598-2-22, UNI EN 1838, UNI 11222, EN 62034

Applications



Service sectors, industry

DV 20m

DV 30m

DV 60m

W	Dimensioni Dimensions mm			Distanza di visibilità Distance of visibility (DV)
	L	B	H	
2	299	155	30	20 m
3	314	194	30	30 m
6	629	355	30	60 m

	Cod.	W	Descrizione Description	Versione Version	Autonomia Autonomy h	Distanza visibilità Distance of visibility DV	Assorbimento Absorbed Power		Note Notes
							DC	AC	
TR	4320		EXIT DF20M SA 1/2/3H RM	SE/SA	1/2/3	20m		2.5 W	
	4321		EXIT DF30M SA 1/2/3H RM	SE/SA	1/2/3	30m		3.5 W	
	4322		EXIT DF60M SA 1/2/3H RM	SE/SA	1/2/3	60m		7W	
AT	4385		EXIT DF20M AT SA	SE/SA/PS	1/1.5/2/3/8	20m		5 W	
	4386		EXIT DF30M AT SA	SE/SA/PS	1/1.5/2/3/8	30m		5 W	
	4387		EXIT DF60M AT SA	SE/SA/PS	1/1.5/2/3/8	60m		5 W	
CT	4380		EXIT DF20M CT SA	SE/SA/PS	1/1.5/2/3/8	20m		5 W	
	4381		EXIT DF30M CT SA	SE/SA/PS	1/1.5/2/3/8	30m		5 W	
	4382		EXIT DF60M CT SA	SE/SA/PS	1/1.5/2/3/8	60m		5 W	
<p>Gli apparecchi CT possono integrare dispositivi opzionali per l'espansione ad altri sistemi: Modulo LG cod.15036 - Modulo LGFM Cod.15037 - Modulo DALI cod.15038 <i>The CT luminaires can integrate optional devices for expansion to other systems: LG Module cod.15036 - LGFM Module cod.15037 - DALI Module cod.15038</i></p>									
CTS	LG230								
	17911		EXIT LG230 DF20M	SE/SA		20m	2.6 W	6.1 VA	
	17912		EXIT LG230 DF30M	SE/SA		30m	4.1 W	8.3 VA	
	17913		EXIT LG230 DF60M	SE/SA		60m	4.1 W	8.3 VA	
	LG24								
	17914		EXIT LG24 DF20M	SE/SA		20m	2.5 W		
	17915		EXIT LG24 DF30M	SE/SA		30m	3.7 W		
	17916		EXIT LG24 DF60M	SE/SA		60m	3.7 W		
	LG EPS								
	31323		EXIT LG EPS DALI 20M	SE/SA		20m		6.1 VA	
	31324		EXIT LG EPS DALI 30M	SE/SA		30m		8.3 VA	
	31325		EXIT LG EPS DALI 60M	SE/SA		60m		8.3 VA	
HT	HT230								
	17917		EXIT HT DF20M	HT		20m	3.1 W	6.6 VA	
	17918		EXIT HT DF30M	HT		30m	4.7 W	9.5 VA	
17919		EXIT HT DF60M	HT		60m	4.7 W	9.5 VA		

ACCESSORI - in dotazione / ACCESSORIES - included



**SCHERMI SX/DX/BASSO
LH/RH/DOWN SCREENS**
 Serigrafia su policarbonato opale
 Screen print on opal polycarbonate



**STAFFA UNIVERSALE
UNIVERSAL BRACKET**

ACCESSORI - da ordinare separatamente / ACCESSORIES - to be ordered separately



MODULO / MODULE LG - LGFM - DALI

Solo per apparecchi CT / CT version only

LG - Cod. **15036**

LGFM - Cod. **15037**

DALI - Cod. **15038**

LG

LGFM

DALI



TELECOMANDO INIBIT RM RM INIBIT REMOTE CONTROL

Solo apparecchi TR e AT equipaggiati di modulo RM
Only TR and AT devices equipped with RM module

Cod. **2730**

RM



ACCESSORIO INCASSO SOFFITTO CEILING RECESSED MOUNTING ACCESSORY

Distanza di visibilità / Distance of visibility
(DV) 20-30 m

Cod. **4312** (20 m) - **4313** (30 m)



ACCESSORIO SOSPENSIONE CON CAVI SUSPENDED MOUNTING ACCESSORY WITH CABLES

Cod. **14771**



KIT BINARIO TRIFASE THREE-PHASE TRACK KIT

Cod. **4319**



STAFFA A PARETE PER BANDIERA EDGE MOUNTING WALL BRACKET

Solo per versioni 60m / 60m versions only

Cod. **19045**



SOSPENSIONE TIGES SUSPENDED MOUNTING RODS

250 - 500 - 1000 mm

Cod. **4315** (250mm) - **4316** (500mm)
4317 (1000mm)



135 segnaletica / exit sign

UpLED Bandiera IP65

emergenza / emergency



Caratteristiche

Installazioni parete, plafone, binario trifase

Corpo Policarbonato, bianco RAL 9003

Schermo Policarbonato opale

Conformità EN 60598-1, EN 60598-2-22, UNI EN 1838, UNI 11222, EN 62034

Applicazioni

Industriale, terziario, ospedali, scuole, retail dove è richiesta elevata distanza di visibilità

Characteristics

Mounting Wall, ceiling, three-phase track

Housing Polycarbonate, white RAL 9003

Screen Opal polycarbonate

Compliance EN 60598-1, EN 60598-2-22, UNI EN 1838, UNI 11222, EN 62034

Applications

Industry, service sectors, hospitals, schools, retail where a high visibility distance is required

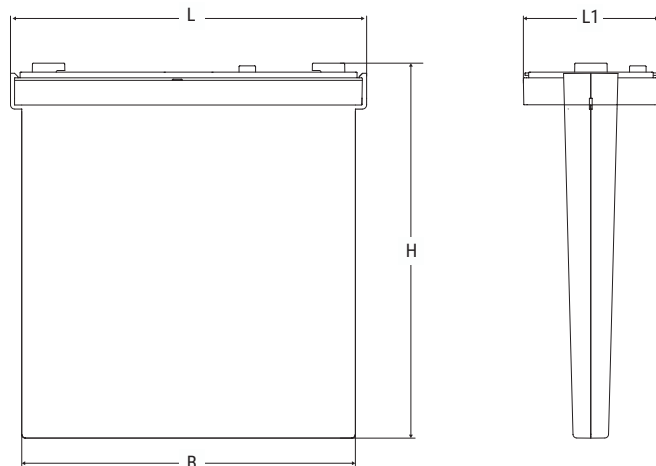

Dimensioni Dimensions mm				Distanza di visibilità Distance of visibility (DV)
B	H	L	L1	
205	230	218	83	40 m

	Cod. ord.	W	Descrizione Description	Versione Version	Autonomia Autonomy h	Distanza visibilità Distance of visibility DV	Assorbimento Absorbed Power		Note Notes
							DC	AC	
TR	824BA		UPLED BAND 824BA SA IP65 1.5	SE/SA	1.5	40m		2.3W	
AT	4376BA		UPLED BAND IP65 AT SA	SE/SA	1/1.5/2/3/8	40m		2.9W	
CT	4372BA		UPLED BAND IP65 CT SA	SE/SA	1/1.5/2/3/8	40m		2.9W	

Gli apparecchi CT possono integrare dispositivi opzionali per l'espansione ad altri sistemi: Modulo LG cod.15036 - Modulo LGFM Cod.15037 - Modulo DALI cod.15038
The CT luminaires can integrate optional devices for expansion to other systems: LG Module cod.15036 - LGFM Module cod.15037 - DALI Module cod.15038

ACCESSORI - in dotazione / ACCESSORIES - included

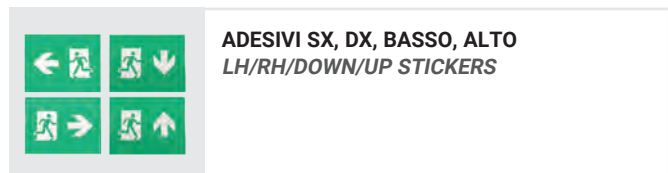

ACCESSORI - da ordinare separatamente / ACCESSORIES - to be ordered separately

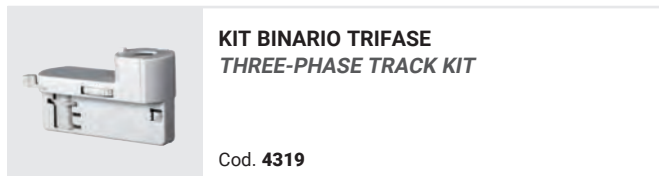
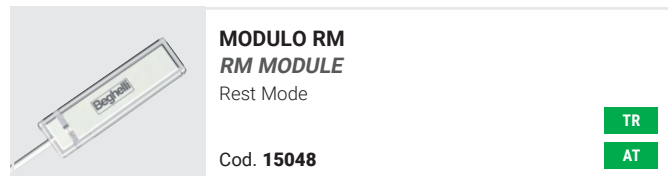



Caratteristiche

Installazioni parete

Corpo Acciaio verniciato alle polveri, bianco RAL 9010

Lente PMMA ad elevata trasparenza

Conformità EN 60598-1, EN 60598-2-22, EN 60598-2-2, EN 62034, UNI EN 1838, UNI 11222, EN 60598-2-22

Applicazioni

Industriale, terziario, ospedali, hotel

Characteristics

Mounting Wall

Housing Powder coated stainless steel, white RAL 9010

Lens Highly transparent PMMA

Compliance EN 60598-1, EN 60598-2-22, EN 60598-2-2, EN 62034, UNI EN 1838, UNI 11222, EN 60598-2-22

Applications

Industry, service sectors, hospitals, hotels

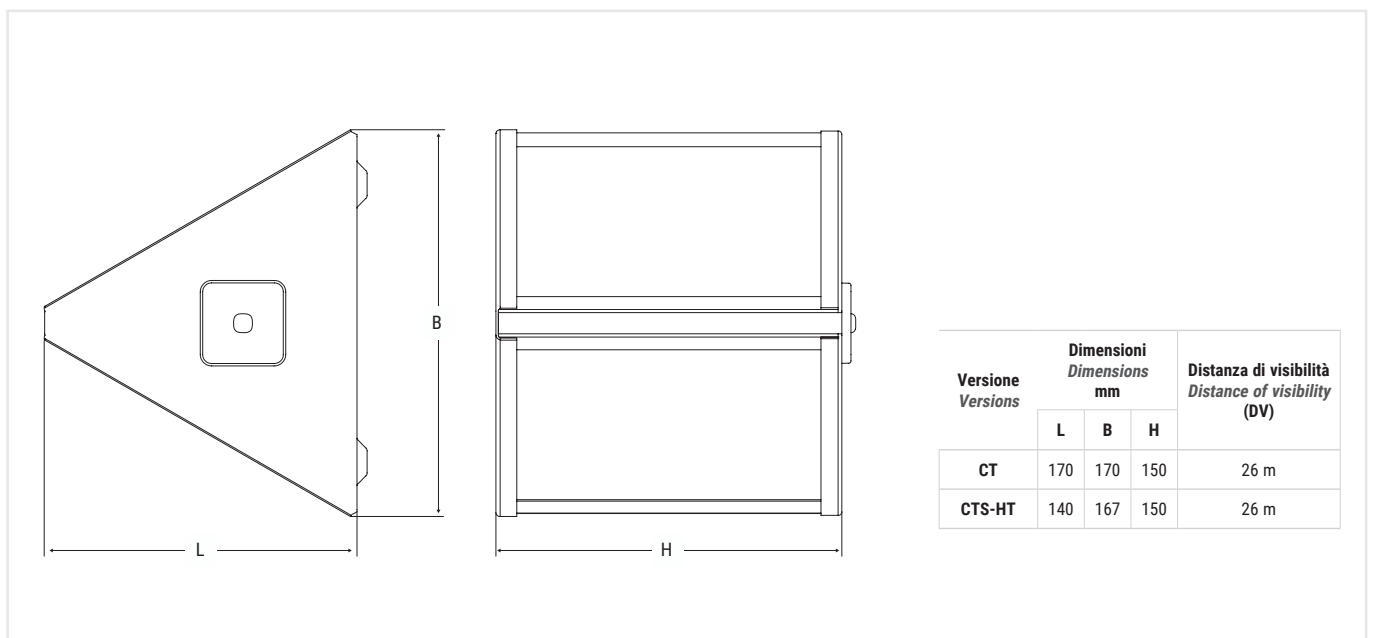

Versione Versions	Dimensioni Dimensions mm			Distanza di visibilità Distance of visibility (DV)
	L	B	H	
CT	170	170	150	26 m
CTS-HT	140	167	150	26 m

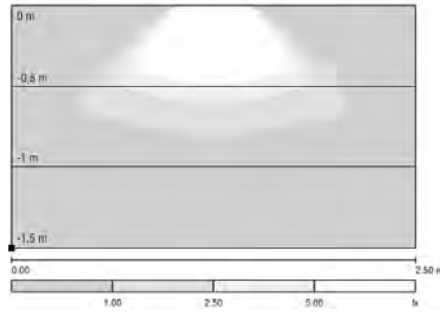

illuminazione dei dispositivi di sicurezza
Illumination of safety devices

SIGN LED 90%

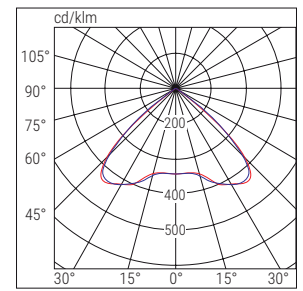

■ C0-C180 ■ C90-C270

	Cod.	Descrizione Description	Versione Version	Autonomia Autonomy h	Distanza visibilità Distance of visibility DV	Flusso Flux SE lm	Flusso Flux SA lm	Assorbimento Absorbed Power		Note Notes	
								DC	AC		
CT	37225	SIGNLED 26M CT	SE/SA/PS	1/1.5/2/3/8	26 m	380/380/304/220/50	243		10W		
CTS	LG230										
	31103	SIGNLED LG230	SE/SA		26 m	380	380	7.6W	15.7VA		
	LG24										
	32074	SIGNLED LG24	SE/SA		26 m	380	380	6.7W			
HT	LG EPS										
	31316	SIGNLED LG EPS DALI	SE/SA		26 m	380	380		15.7VA		
	31317	SIGNLED HT	HT		26 m	380	380	7.6W	15.7VA		

ACCESSORI - da ordinare separatamente / **ACCESSORIES** - to be ordered separately

SCHERMO ESTINTORE
FIRE EXTINGUISHER SCREEN

Cod. **E16914M**

SCHERMO PRONTO SOCCORSO
FIRST AID SCREEN

Cod. **E16910M**

SCHERMO PULSANTE DI EMERGENZA
EMERGENCY BUTTON SCREEN

Cod. **E16913M**

SCHERMO TELEFONO EMERGENZA
EMERGENCY TELEPHONE SCREEN

Cod. **E16912M**

SCHERMO MANICHETTA ANTINCENDIO
FIRE EXTINGUISHING HOSE SCREEN

Cod. **E16915M**

SCHERMO PUNTO DI RACCOLTA
ASSEMBLY POINT SCREEN

Cod. **E16911M**

Dispos evo

emergenza / emergency



IP40

IK05

850°

CTS - HT

+40°C
-20°C



+40°C
0°C

Caratteristiche

Installazioni parete, soffitto, bandiera, incasso, sospensione

Corpo Acciaio verniciato alle polveri di colore bianco RAL 9010

Schermo PMMA trasparente serigrafato

Lente PMMA ad elevata trasparenza

Conformità EN 60598-1, EN 60598-2-22, EN 60598-2-2, EN 62034, UNI EN 1838, UNI 11222, EN 60598-2-22

Applicazioni

Industriale, terziario, ospedali, hotel

Characteristics

Mounting Wall, ceiling, edge mounting, recessed, suspended

Housing Powder coated steel, white RAL 9010

Screen PMMA opal

Lens Highly transparent PMMA



Compliance EN 60598-1, EN 60598-2-22, EN 60598-2-2, EN 62034, UNI EN 1838, UNI 11222, EN 60598-2-22

Applications

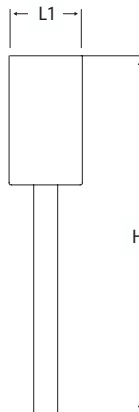
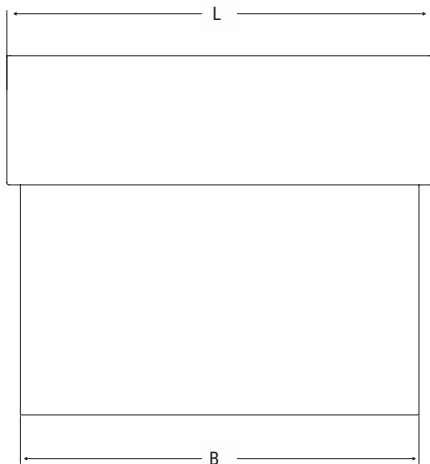
Industry, service sectors, hospitals, hotels



Dimensioni Dimensions mm				Distanza di visibilità Distance of visibility (DV)
B	H	L	L1	
250	233	267	46	22 m
325	274	342	46	30 m

	Cod.	Descrizione Description	Versione Version	Autonomia Autonomy h	Distanza visibilità Distance of visibility DV	Flusso Flux SE lm	Flusso Flux SA lm	Assorbimento Absorbed Power		Note Notes	
								DC	AC		
CT	37000	DISPOS EVO 22M CT WA/DA	SE/SA/PS	1/1.5/2/3/8	22 m				5W		
	37006	DISPOS EVO 30M CT WA/DA	SE/SA/PS	1/1.5/2/3/8	30 m				5W		
CTS	LG230										
	31000	DISPOS EVO 22M LG230 WA/DA	SE/SA		22 m			2.5W	5.8VA		
	31002	DISPOS EVO 30M LG230 WA/DA	SE/SA		30 m			4.7W	9.4VA		
	LG24										
	32000	DISPOS EVO 22M LG24 WA/DA	SE/SA		22 m			2.2W			
	32002	DISPOS EVO 30M LG24 WA/DA	SE/SA		30 m			4.3W			
	LG EPS										
	31336	DISPOSEVO 22M LG EPS DALI W/D	SE/SA		22 m				5.8VA		
	31337	DISPOSEVO 30M LG AC DALI W/D	SE/SA		30 m				9.4VA		
	HT	31338	DISPOSEVO 22M HT W/D	HT		22 m			2.5W	5.8VA	
31339		DISPOSEVO 30M HT W/D	HT		30 m			4.7W	9.4VA		

ACCESSORI - da ordinare separatamente / ACCESSORIES - to be ordered separately



**ADESIVI SX/DX
STICKERS LH/RH**

DV 22m Cod. E16261M
DV 30m Cod. E16129M



**ADESIVO BASSO
DOWN STICKER**

DV 22m Cod. E16260M
DV 30m Cod. E16128M



**ADESIVO ALTO
UP STICKERS**

DV 22m Cod. E16263M
DV 30m Cod. E16132M



KIT INCASSO / RECESSED MOUNTING KIT

DV 22m - Cod. F95947
DV 30m - Cod. F95948



**STAFFA A PARETE PER BANDIERA
EDGE MOUNTING WALL BRACKET**

DV 22m - Cod. F95949
DV 30m - Cod. F95950



IP42

IK03

850°

CTS - HT
+40°C
-20°C



+40°C
0°C

Caratteristiche

Installazioni soffitto, sospensione

Corpo Acciaio verniciato alle polveri, bianco RAL 9003

Schermo PMMA opale

Conformità EN 60598-1, EN 60598-2-22, EN 60598-2-2, EN 62034, UNI EN 1838, UNI 11222, EN 60598-2-22

Applicazioni

Industriale, terziario, ospedali, Hotel

Characteristics

Mounting Ceiling, suspended

Housing Powder coated steel, white RAL 9003

Screen PMMA opal

Compliance EN 60598-1, EN 60598-2-22, EN 60598-2-2, EN 62034, UNI EN 1838, UNI 11222, EN 60598-2-22

Applications

Industry, service sectors, hospitals, hotels

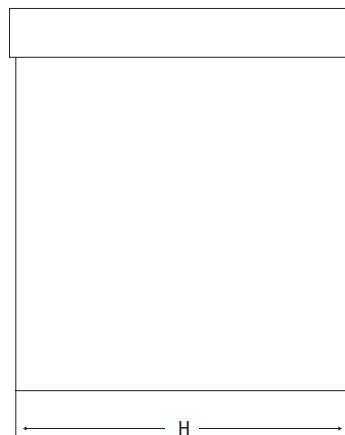
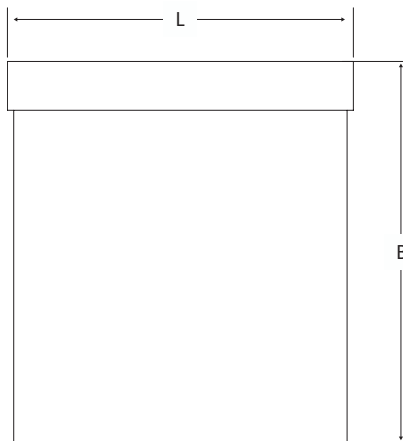

Dimensioni Dimensions mm			Distanza di visibilità Distance of visibility (DV)
L	H	B	
243	238	273	22 m - 44 m

	Cod.	Descrizione Description	Versione Version	Autonomia Autonomy h	Distanza visibilità Distance of visibility DV	Flusso Flux SE lm	Flusso Flux SA lm	Assorbimento Absorbed Power		Note Notes	
								DC	AC		
CT	37072	QUADER 44M CT	SE/SA/PS	1/1.5/2/3/8	22 - 44 m				5W		
CTS	LG230										
	31024	QUADER 44M LG230	SE/SA		22 - 44 m			4.7W	9.4VA		
	LG24										
	32024	QUADER 44M LG24	SE/SA		22 - 44 m			4.3W			
HT	LG EPS										
	31326	QUADER 44M LG EPS DALI	SE/SA		22 - 44 m				9.4VA		
	31327	QUADER 44M HT	HT		22 - 44 m			4.7W	9.4VA		

ACCESSORI - da ordinare separatamente / ACCESSORIES - to be ordered separately



ADESIVO BASSO
DOWN STICKERS

DV 22m Cod. F15330M
DV 44m Cod. F15325M



ADESIVO DX
RH STICKERS

DV 22m Cod. F15331M
DV 44m Cod. F15326M



ADESIVO ALTO
UP STICKERS

DV 22m Cod. F15329M
DV 44m Cod. F15328M



ADESIVO SX
SX STICKERS

DV 22m Cod. F15332M
DV 44m Cod. F15327M



GANCI PER SOSPENSIONE
SUSPENDED MOUNTING HOOKS

Cod. F95406

Piana

emergenza / emergency



Caratteristiche

Installazioni parete, soffitto, bandiera, incasso

Corpo ABS bianco RAL 9003

Schermo ABS bianco RAL 9003

Conformità EN 60598-1, EN 60598-2-22, EN 60598-2-2, EN 62034, UNI EN 1838, UNI 11222, EN 60598-2-22

Applicazioni

Terziario

Characteristics

Mounting Wall, ceiling, edge mounting, recessed,

Housing ABS, white RAL 9003

Screen ABS, white RAL 9003

Compliance EN 60598-1, EN 60598-2-22, EN 60598-2-2, EN 62034, UNI EN 1838, UNI 11222, EN 60598-2-22

Applications

Service sectors

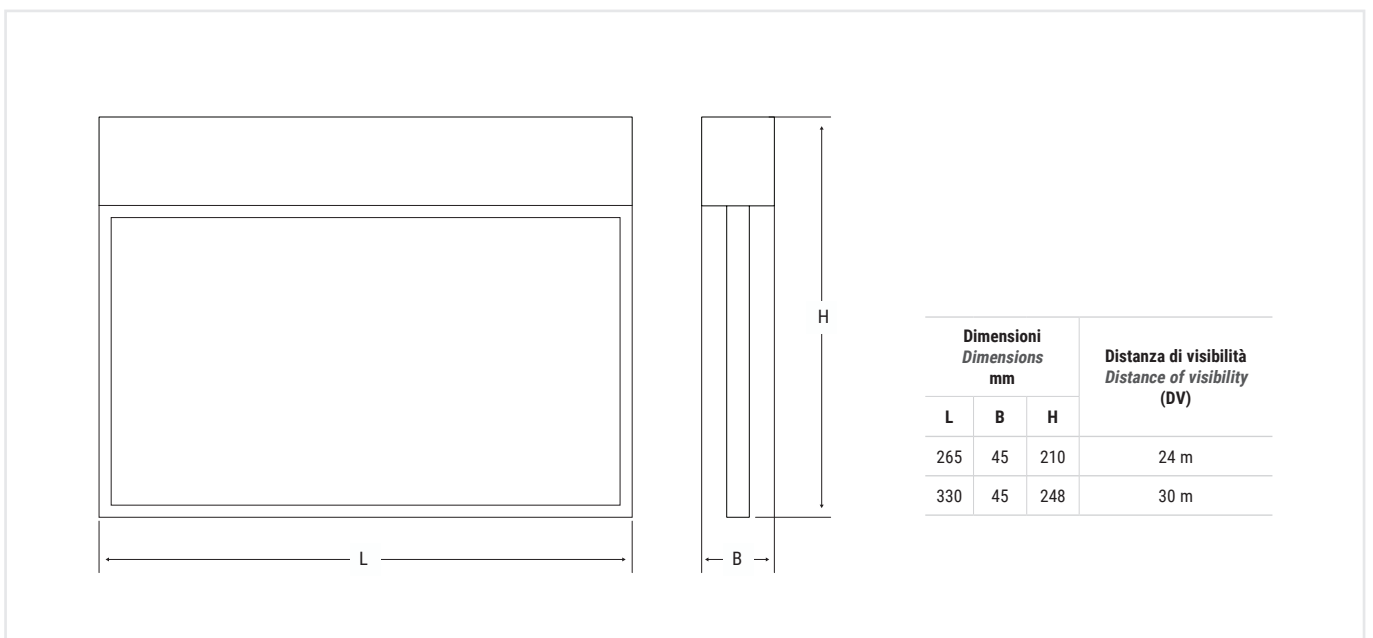

	Cod.	Descrizione Description	Versione Version	Autonomia Autonomy h	Distanza visibilità Distance of visibility DV	Flusso Flux SE Im	Flusso Flux SA Im	Assorbimento Absorbed Power		Note Notes	
								DC	AC		
CT	37168	PIANALED 24M CT WA/DA	SE/SA/PS	1/1.5/2/3/8	24 m				5W		
	37171	PIANALED 30M CT WA/DA	SE/SA/PS	1/1.5/2/3/8	30 m				5W		
	37174	PIANALED 24M CT SP	SE/SA/PS	1/1.5/2/3/8	24 m				5W		
	37177	PIANALED 30M CT SP	SE/SA/PS	1/1.5/2/3/8	30 m				5W		
CTS	LG230										
	31116	PIANALED 24M LG230 WA/DA	SE/SA		24 m			3.5W	7.4VA		
	31117	PIANALED 30M LG230 WA/DA	SE/SA		30 m			3.5W	7.4VA		
	31118	PIANALED 24M LG230 SP	SE/SA		24 m			3.5W	7.4VA		
	31119	PIANALED 30M LG230 SP	SE/SA		30 m			3.5W	7.4VA		
	LG24										
	32085	PIANALED 24M LG24 WA/DA	SE/SA		24 m			2.9W			
	32086	PIANALED 30M LG24 WA/DA	SE/SA		30 m			2.9W			
	32087	PIANALED 24M LG24 SP	SE/SA		24 m			2.9W			
	32088	PIANALED 30M LG24 SP	SE/SA		30 m			2.9W			
	LG EPS										
	31328	PIANALED 24M LG EPS DALI W/C	SE/SA		24 m				7.4VA		
31329	PIANALED 30M LG EPS DALI W/C	SE/SA		30 m				7.4VA			
31330	PIANALED 24M LG EPS DALI SP	SE/SA		24 m				7.4VA			
31331	PIANALED 30M LG EPS DALI SP	SE/SA		30 m				7.4VA			
HT	31332	PIANALED 24M HT W/C	HT		24 m			3.5W	7.4VA		
	31333	PIANALED 30M HT W/C	HT		30 m			3.5W	7.4VA		
	31334	PIANALED 24M HT SP	HT		24 m			3.5W	7.4VA		
	31335	PIANALED 30M HT SP	HT		30 m			3.5W	7.4VA		

ACCESSORI - da ordinare separatamente / ACCESSORIES - to be ordered separately



**ADESIVO ALTO
UP STICKERS**

DV 24m Cod. E16031M
DV 30m Cod. E16032M



**KIT ADESIVI 45°
45° STICKERS KIT**

DV 24m Cod. E16029M
DV 30m Cod. E16030M



KIT INCASSO / RECESSED MOUNTING KIT

DV 24m - Cod. F94002
DV 30m - Cod. F94001

Inverter Universale



WEB CATALOGUE

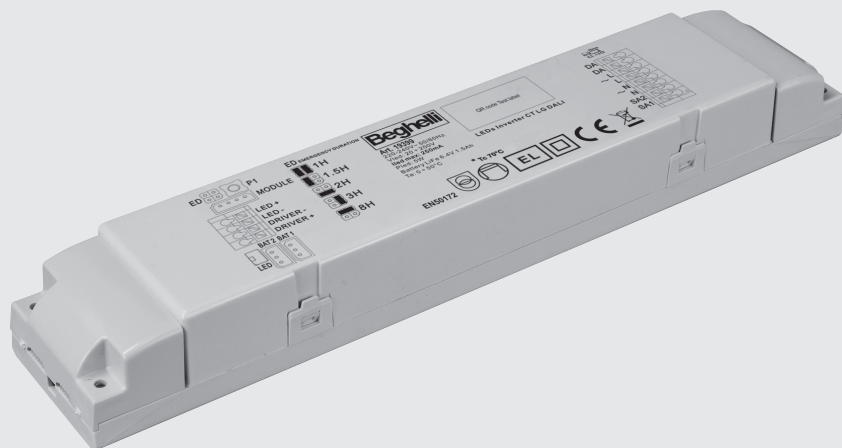

IP20

IK05

850°



+50°C
0°C



Caratteristiche

Alimentazione 230Vac, 50÷60Hz

Tensione di uscita 20V-240V

Corrente max di uscita 250mA

LED di stato Bi-color

Corpo Policarbonato

Conformità EN 61347-2-7, EN 61347-1, EN 60598-1

Applicazioni

Terziario, Industriale all'interno di apparecchi IP65

Characteristics

Power supply 230VAC, 50÷60Hz

Output voltage 20V-240V

Max. output current 250mA

Status LED Two colours

Housing Polycarbonate

Compliance EN 61347-2-7, EN 61347-1, EN 60598-1

Applications

Service sectors, industry, in high performance IP65 luminaires or with a IP65 enclosure installed.

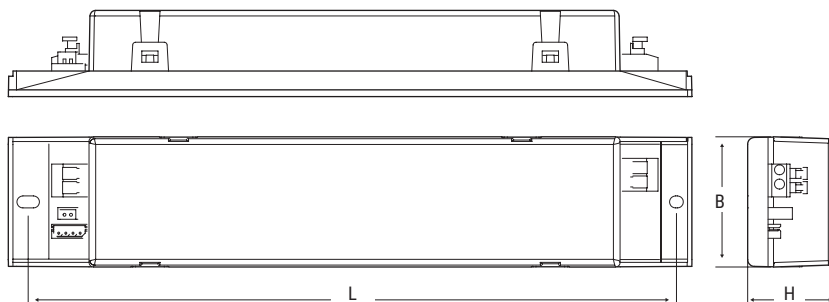

Versione Version	Dimensioni Dimensions mm					
	L	B	H	L1	B1	H1
9W	232	30	26	72	60	20
15W	232	30	26	132	37	19

ANDAMENTO DELLA POTENZA IN FUNZIONE DELLA TENSIONE DEI LED / POWER TREND ACCORDING TO LED VOLTAGE

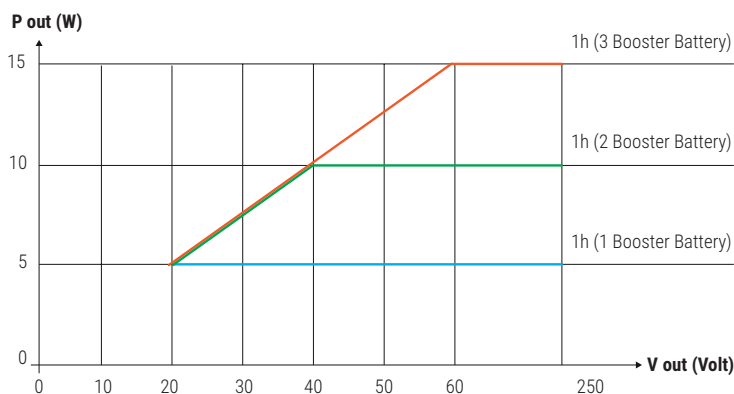

CALCOLO DEL FLUSSO INTEGRANDO L'INVERTER UNIVERSALE FLUX CALCULATION INTEGRATING UNIVERSAL INVERTER

L'Inverter universale è dotato di interfaccia idonea per il collegamento con qualsiasi apparecchio di illuminazione ordinaria. Una volta integrato l'Inverter, l'apparecchio è in grado di produrre le massime prestazioni illuminotecniche ottenibili. Nell'esempio il calcolo del Flusso nominale in emergenza di una BS UNO con Inverter Universale integrato.

The Universal inverter is equipped with an interface designed for connection with any ordinary lighting fixture. Connecting the Inverter to the luminaire it is able to produce the maximum lighting performance. Find below the calculation method and an example with universal inverter for determining the rated flux in emergency mode.

$$\text{Flusso / Flux em} = P_{inv} \times F_n / P_n$$

P_{inv} = Potenza Inverter / Inverter Power (versione / version 1h = 15W)

F_n = Flusso apparecchio / Rated flux (BS UNO = 12000lm)

P_n = Potenza LED / LED Power (BS UNO = 72W)

$$\text{Flusso / Flux em} = 15 \times 12000\text{lm} / 72 = \mathbf{2500\text{lm}}$$

	Cod.	Descrizione Description	Output Voltage V	Autonomia Autonomy h	P out W	BOOSTER BATTERY aumenta la potenza increases power	Assorbimento Absorbed Power AC	Note Notes
AT	19398	INV UNIV AT RM 5W 20-240V	20-240	1/1.5/2/3/8	5/3.3/2.5/1.7/0.7	10W - 1 Booster / 15W - 2 Booster	3.9W	IP40
CT	19399	INV UNIV CT 5W 20-240V	20-240	1/1.5/2/3/8	5/3.3/2.5/1.7/0.7	10W - 1 Booster / 15W - 2 Booster	3.9W	IP40

ACCESSORI - da ordinare separatamente / ACCESSORIES - to be ordered separately

MODULO / MODULE LG - LGFM - DALI
Solo per apparecchi CT / CT version only

LG - Cod. 15079
LGFM - Cod. 15037
DALI - Cod. 15080

BOOSTER BATTERY (AT - CT version)
1 Batteria - Raddoppia Potenza 10W e Flusso emergenza
2 Batterie - Triplica Potenza 15W e Flusso emergenza
1 Battery - Double Power 10W and emergency Flux
2 Battery - Triple Power 15W and emergency Flux

Cod. **RA13**

Inverter LED



Caratteristiche

- Alimentazione** 230Vac, 50÷60Hz
- Tensione** di uscita 5V - 55V
- P in max** driver 1500VA
- V in max** driver 250VAC
- Corrente** max di uscita 500mA
- LED** di stato Bi-color
- Corpo** Polycarbonato
- Conformità** EN 61347-2-7, EN 61347-2-13, EN 61347-1, EN 62034

Applicazioni

Terziario, Industriale all'interno di apparecchi IP65 ad elevate prestazioni o con Guscio IP65 installato.

Characteristics

- Power supply** 230VAC, 50÷60Hz
- Output voltage** 5V - 55V
- P in max** driver 1500VA
- V in max** driver 250VAC
- Max. output current** 500mA
- Status LED** Two colours
- Housing** Polycarbonate
- Compliance** EN 61347-2-7, EN 61347-2-13, EN 61347-1, EN 62034

Applications

service sectors, industry, in high performance IP65 luminaires or with a IP65 enclosure installed.

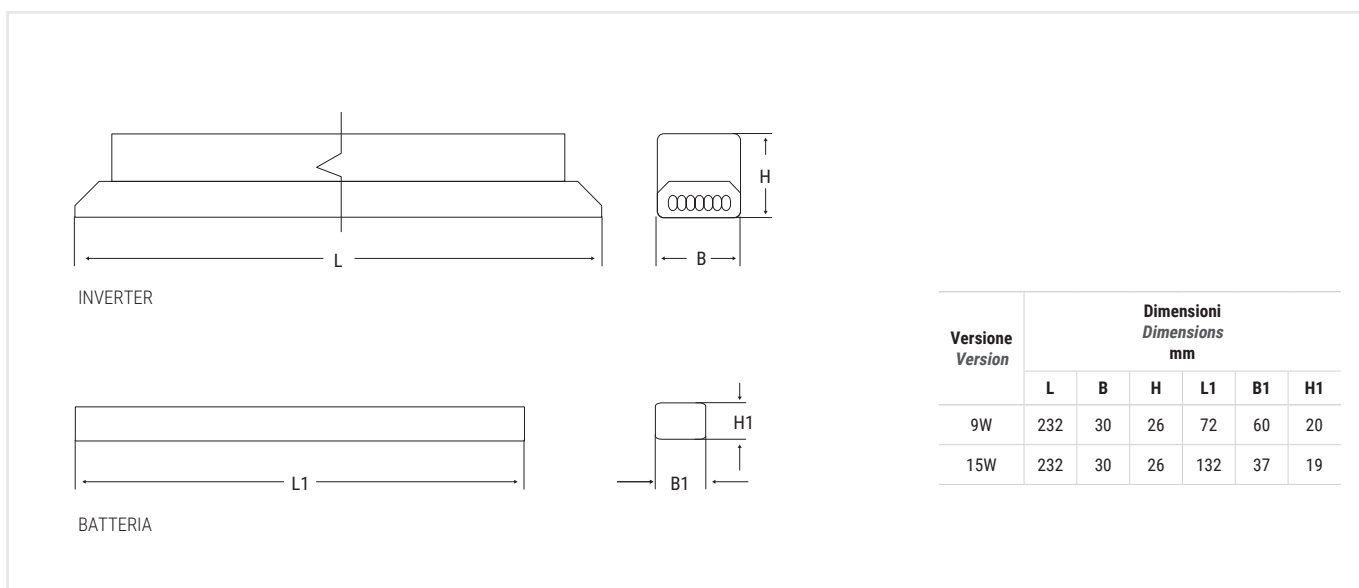

Versione Version	Dimensioni Dimensions mm					
	L	B	H	L1	B1	H1
9W	232	30	26	72	60	20
15W	232	30	26	132	37	19

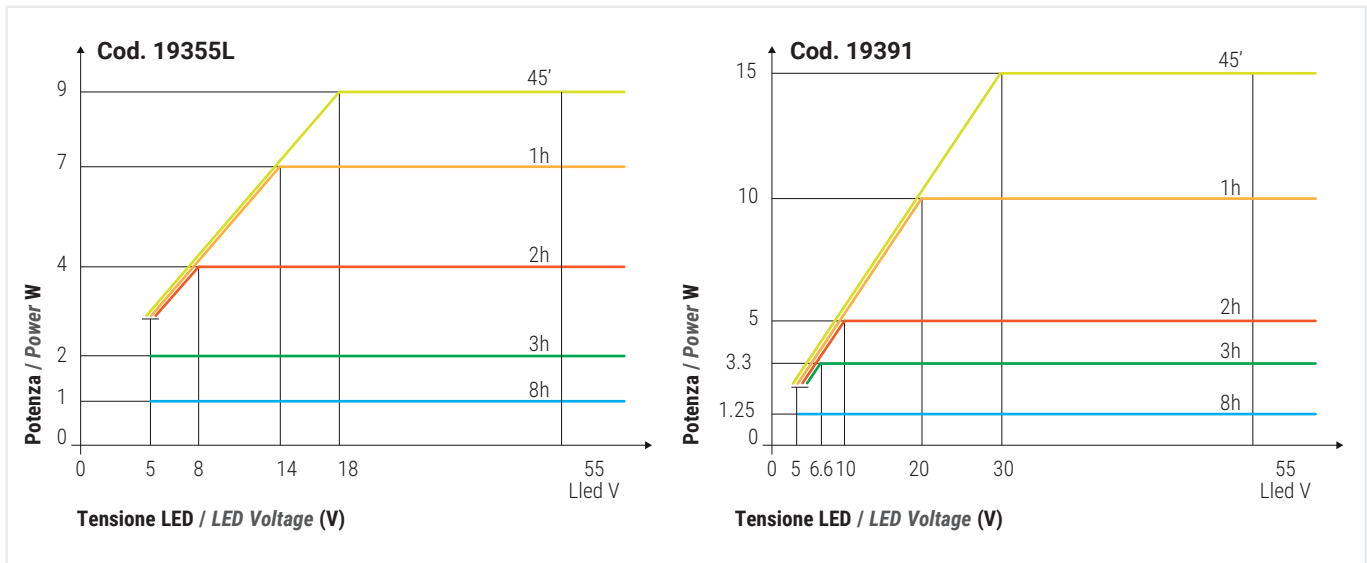

ANDAMENTO DELLA POTENZA IN FUNZIONE DELLA TENSIONE DEI LED / POWER TREND ACCORDING TO LED VOLTAGE

La potenza di uscita è subordinata alla corrente massima di uscita di 500mA. Per esempio l'inverter 1955L, settato a 1h di autonomia, garantisce i 7W di uscita solo se usato per alimentare un gruppo LED con Vled>14Volt, sotto a tale tensione la potenza si riduce come indicato nel grafico.

The output power is subordinated to the maximum output current of 500mA (e.g., with the inverter set to 1h of autonomy, it will guarantee a 7W output when only used to power an LED set with Vled>14Volt; below this voltage, the power is reduced as shown in the graph.



ESEMPIO DI CALCOLO DEL FLUSSO DI BS100 SD CON INVERTER LED CON 1H DI AUTONOMIA EXAMPLE OF FLUX CALCULATION FOR BS100 SD WITH LED INVERTER WITH 1h OF AUTONOMY (Cod. 19391)

L'Inverter LED è in grado di realizzare le massime prestazioni illuminotecniche ottenibili dall'apparecchio su cui è installato. Di seguito il metodo di calcolo e l'esempio per calcolare il dato di Flusso Nominale ottenibile in emergenza

The LED Inverter can achieve an excellent lighting performance of the luminaire on which it is installed. Please find below the calculation method and an example for determining the Rated Flux in emergency mode.

Flusso / Flux = P inverter x Fn / Pn dove / where:

- P= Potenza nominale Inverter/ Inverter rated power (1h = 10W)
- Fn= Flusso nominale apparecchio/ Rated luminaire flux (BS100 LED = 8350lm)
- Pn= Potenza nominale / Rated power (BS100 LED = 64W)

Flusso / Flux = 10 x 8350 lm / 64 = 1304lm

Autonomia 1h - Flusso 1304lm
1h Autonomy - 1304 lm Flux

Il calcolo non tiene conto della miglior efficienza che l'apparecchio ha se pilotato con potenze molto ridotte rispetto ai valori nominali, in questo caso i flussi risultano essere sottostimati / The calculation does not take into account the improved efficiency of the luminaire when driven with very low power compared to the nominal values, in which case the fluxes are underestimated.

Inverter LED

emergenza / emergency

	Cod.	Descrizione <i>Description</i>	Output Voltage V	Autonomia <i>Autonomy</i> h	P out W	BOOSTER BATTERY raddoppia l'Autonomia increases autonomy	Assorbimento <i>Absorbed Power</i> AC	Note <i>Notes</i>
CT	LG							
	19355L	INVERTER LED AT/LG AR 9W 55V	5-55	0.75/1/2/3/8	9/7/4/2/1	1.5/2/4/6/16	2.8W	
	19391*	INVERTER GL AT/LG AR 15W 55V	5-55	0.75/1/2/3/8	15/10/5/3.3/1.25	1.5/2/4/6/16	3.7W	

Gli Inverter CentralTest sono disponibili in versione LG, possono integrare il dispositivo opzionale per l'espansione al sistema radio LGFM: Modulo LGFM cod.15037
 The CentralTest Inverters are available in the LG version, they can integrate the optional device for expansion to the LGFM radio system: LGFM Module cod. 15037

* Garanzia 5 anni / 5 years guarantee

ACCESSORI - da ordinare separatamente / ACCESSORIES - to be ordered separately

	<p>BOOSTER BATTERY Compatibile con / <i>Compatible with</i> Cod. 19355L</p> <p>Cod. RA06 - LiFe 9,6V 1,5Ah</p>		<p>COVER INVERTER IP65 Dimensioni / <i>Dimensions</i> 301x139x55mm</p> <p>Cod. 19376</p>
	<p>BOOSTER BATTERY Compatibile con / <i>Compatible with</i> Cod. 19391</p> <p>Cod. Ord. RA08 - LiFe 12,8V 1,5Ah</p>		<p>MODULO LGFM LGFM MODULE</p> <p>Cod. 19375 (LGFM)</p> <p style="text-align: right;">LGFM</p>

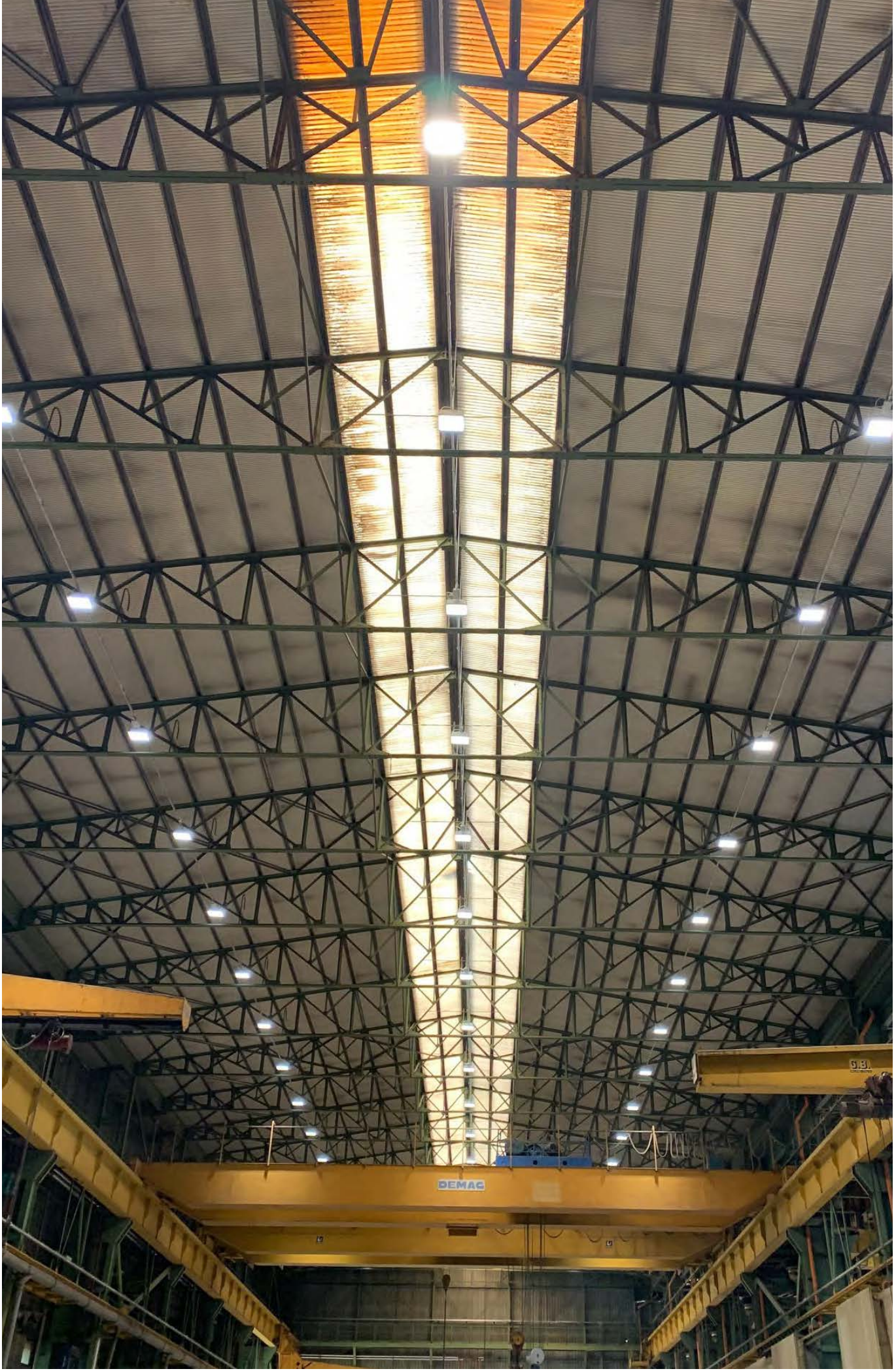

151 kit di conversione in emergenza / emergency conversion kit

Inverter LED Plug&Light

emergenza / emergency



Caratteristiche

- Alimentazione** 230Vac, 50÷60Hz
- Tensione di uscita** 20 - 60 Vdc (Cod. 19358, 19359), 60 - 180Vdc (Cod. 19367)
- Corrente max di uscita** 160 mA
- LED di stato** Bi-color con guidaluce in PC (BCS)
- Corpo** Polycarbonato
- Conformità** EN 61347-2-7, EN 61347-1, EN 60598-1

Applicazioni

Terziario, Industriale all'interno di apparecchi IP65

Characteristics

- Power supply** 230VAC \pm 10%, 50÷60Hz
- Output voltage** 20 - 60 VDC (Order Code 19358, 19359), 60 - 180VDC (Order Code 19367)
- Max. output current** 160 mA
- Status LED** Two colours with PC light guide (BCS)
- Housing** Polycarbonate
- Compliance** EN 61347-2-7, EN 61347-1, EN 60598-1

Applications

Service sectors, industry, inside IP65 luminaires

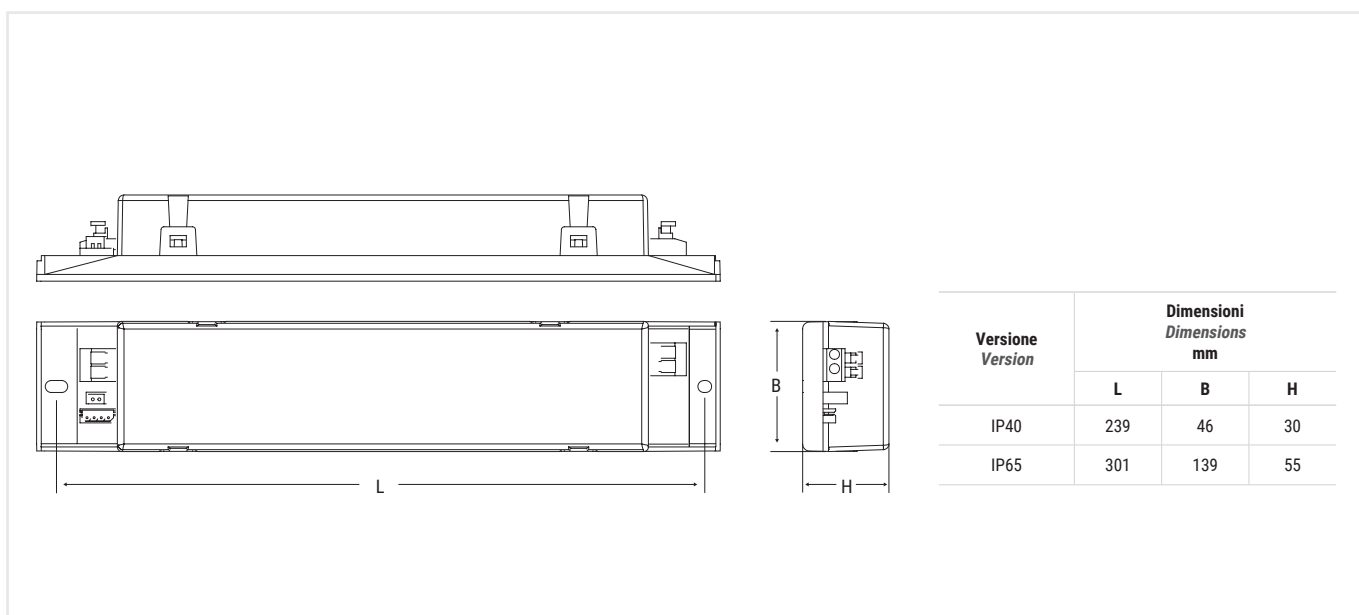



Autonomia / Autonomy 1h
Flusso / Flux 417lm

CALCOLO DEL FLUSSO DI BS 100 LED (SMART DRIVER) CON INVERTER LED CON 1h DI AUTONOMIA (Cod. 19358) EXAMPLE OF FLUX CALCULATION FOR BS 100 LED (SMART DRIVER) WITH LED INVERTER WITH 1h OF AUTONOMY (Order 19358)

L'Inverter LED è in grado di realizzare le massime prestazioni illuminotecniche ottenibili dall'apparecchio su cui è installato. Di seguito il metodo di calcolo e l'esempio per calcolare il dato di Flusso Nominale ottenibile in emergenza

The LED Inverter can guarantee the maximum lighting performance that the luminaire on which it is installed can achieve. Please find below the calculation method and an example for determining the Rated Flux in emergency mode

Flusso / Flux = P inverter x Fn / Pn dove / where:

P= Potenza nominale Inverter/ Inverter rated power (1h = 3,2W)

Fn= Flusso nominale apparecchio/ Rated luminaire flux (BS100 LED = 8350lm)

Pn= Potenza nominale / Rated power (BS100 LED = 64W)

Flusso / Flux = 3,2 x 8350 lm / 64 = 417lm

	Cod.	Descrizione Description	Output Voltage V	Autonomia Autonomy h	P out W	Assorbimento Absorbed Power AC	Note Notes
TR	19358	INV PLUG&LIGHT LED SE/SA 1H 20-60V	20-60	1	3.2	1W	IP40
	19359	INV PLUG&LIGHT LED SE/SA 3H 20-60V	20-60	3	3	1W	IP40
	19367	INV PLUG&LIGHT LED SE/SA 1H 60-180V	60-180	1	3.2	1W	IP40
	19371	INV PLUG&LIGHT LED SE/SA 3H 60-180V	60-180	3	3	1W	IP40
	19368	INV PLUG&LIGHT LED SE/SA 3H 20-60V IP65	20-60	3	3	1W	IP65
	19373	INV PLUG&LIGHT LED SE/SA 3H 60-180V IP65	60-180	3	3	1W	IP65

ACCESSORI - in dotazione / ACCESSORIES - included





Caratteristiche

Alimentazione 230Vac $\pm 10\%$, 50÷60Hz

Installazione su barra DIN 4 moduli

Dotazioni batteria tampone

Apparecchi gestiti fino a 32 dispositivi di impianti CBL

Interfaccia di collegamento

WiFi - modalità AccesPoint (AP) e modalità Client (STA), Bluetooth (non attivata)

Software di gestione

App B.connect, NuBe, App Cablecom

Conformità EN62034, EN50172, EN60950-12014/53/UE

Applicazioni

Industriale, terziario

Characteristics

Power supply 230VAC $\pm 10\%$, 50÷60Hz

Mounting 4 DIN rail modules

Equipment back-up battery

Managed luminaires up to 32 CBL system luminaires

Connection interface

WiFi - AccesPoint (AP) mode and Client (STA) mode, Bluetooth (not enabled)

Management software

B.connect App, NuBe, Cablecom App

Compliance EN62034, EN50172, EN60950-12014/53/EU

Applications

Industry, service sectors

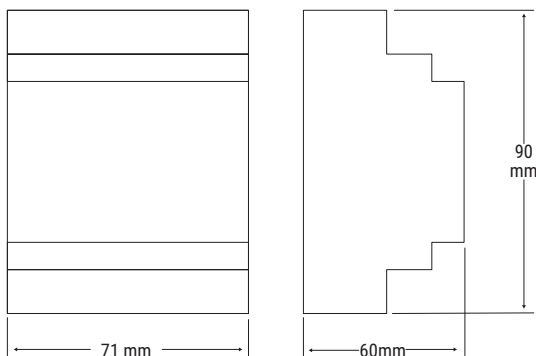

Connect

FUNZIONI

- Sistema modulare
- Apparecchi funzionanti sia in modalità AutoTest che Centraltest CBL
- Autonomia programmabile (1-1,5 -2-3-8h)
- Esecuzione del test posticipabile per una parte dell'impianto (pari / dispari)
- Rotary switch per programmazione manuale
- Possibilità di controllo remoto mediante APP B.connect
- Possibilità di controllo remoto mediante PC con portale NuBe (oltre all'interfacciamento GSM, Ethernet, USB, RS232)
- Possibilità di integrazione con Building Automation
- Operazioni di configurazione centralizzate
- Attivazione funzione Rest Mode
- Attivazione funzione Infinity Mode
- Scaricamento automatico del LogBook impianto in formato PDF, come richiesto dalla Normativa EN UNI 11222

FUNCTIONS

- Modular system
- Luminaires operating in both AutoTest and Centraltest CBL modes.
- Programmable autonomy (1-1.5 -2-3-8hrs)
- Postponable testing for part of the system (even/odd)
- Rotary switch for manual programming
- Possibility of remote control via B.connect APP
- Possibility of remote control via PC with the NuBe portal (in addition to GSM, Ethernet, USB, RS232 interfaces)
- Possibility of integration with Building Automation
- Centralised configuration operations
- Activation of Rest Mode function
- Activation of Infinity Mode function
- Automatic download of the system LogBook in PDF format, as required by the EN UNI 11222 Standard

	Cod.	Descrizione Description	Numero apparecchi Number of luminaires	Numero moduli in barra DIN Number of DIN rail modules
CT	20151	CENTRALE CABLECOM CONNECT	32	4

ACCESSORI - da ordinare separatamente / ACCESSORIES - to be ordered separately



MODULO GSM / GSM MODULE
 Con ingresso LAN Ethernet e alimentatore (1+1 DIN)
 With Ethernet LAN input and power supply (1+1 DIN)
 Slot per SIM (inclusa) / SIM card slot (included)
 Cod. **20157**

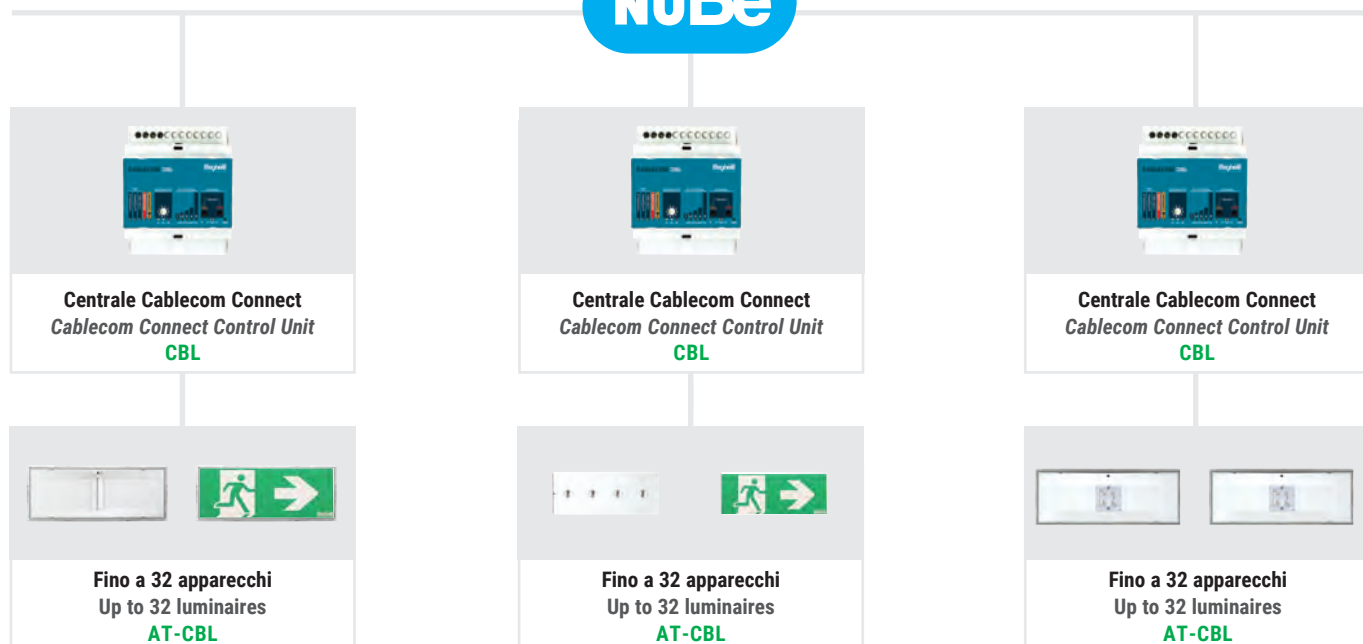

155 centrali per apparecchi autoalimentati / control units for self-contained luminaires



Caratteristiche

Alimentazione 230Vac $\pm 10\%$, 50÷60Hz

Installazione su barra DIN 4 moduli

Dotazioni uscita relè e batteria tampone

Apparecchi gestiti fino a 128 dispositivi ogni centrale LG, integrando la Centrale di supervisione è possibile collegare 31 centrali per un totale di 3968 apparecchi gestibili da un unico punto. In caso di impianti misti è possibile controllare fino a 64 dispositivi DALI + 32 dispositivi LG

Interfaccia di collegamento

WiFi - modalità AccesPoint (AP) e modalità Client (STA), Ethernet, Bluetooth (non attivata), RS485, 4 ingressi puliti, 1 ingresso 230V

Software di gestione

App B.connect, NuBe

Conformità EN60950-1, EN62034, EN50172, 2014/53/UE

Applicazioni

Industriale, terziario

Characteristics

Power supply 230VAC $\pm 10\%$, 50÷60Hz

Mounting 4 DIN rail modules

Equipment Relay output and buffer battery

Managed luminaires up to 128 devices per each LG Control Unit; by integrating the Supervisor Control Unit, it is possible to connect 31 control units for a total of 3968 luminaires that can be managed from a single point. In mixed systems, up to 64 DALI devices + 32 LG devices can be controlled.

Connection interface

WiFi - AccesPoint (AP) mode and Client (STA) mode, Ethernet, Bluetooth (not activated), RS485, 4 x potential-free inputs, 1 x 230V input

Management software

B.connect App, NuBe

Compliance EN60950-1, EN62034, EN50172, 2014/53/EU

Applications

Industry, service sectors

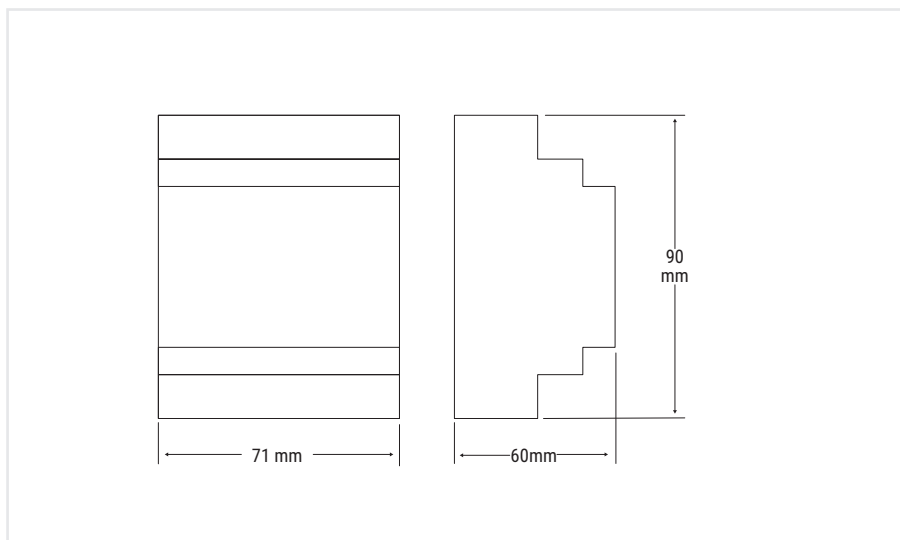

Connect LG

FUNZIONI

- Sistema modulare sia in modalità AT che CT (LG)
- Autonomia programmabile (1ora / 3ore)
- Programmazione dei test anche parziale (pari/dispari)
- Collegamenti cablati Bus Logica
- Bus DALI compatibile per illuminazione DALI (LOGICA)
- Controllo remoto da APP B.connect o PC con Cloud NuBe
- Possibilità di integrazione con Building Automation
- Operazioni di configurazione centralizzate
- 16 gruppi di apparecchi programmabili
- 16 scene di luminosità programmabili

FUNCTIONS

- Modular system operating both AT and CT (LG) modes.
- Programmable autonomy(1hour / 3hours)
- Programming of tests, including partial ones (even/odd))
- Bus Logica wired connections
- Bus DALI-compatible for DALI (LOGICA) luminaires
- Remote control via B.connect APP or PC with NuBe cloud
- Possibility of integration with Building Automation
- Centralized configuration operations
- 16 programmable luminaire groups
- 16 programmable brightness scenes

	Cod.	Descrizione Description	Numero apparecchi Number of luminaires	Numero moduli in barra DIN Number of DIN rail modules
CT	LG			
	12100C	CENTRALE LOGICA CONNECT LG	128	4

ACCESSORI - da ordinare separatamente



MODULO GSM / GSM MODULE
Con ingresso LAN Ethernet e alimentatore (1+1 DIN)
With Ethernet LAN input and power supply (1+1 DIN)
Slot per SIM (inclusa) / SIM card slot (included)

Cod. **20157**



CENTRALE DI SUPERVISIONE/ SUPERVISOR CONTROL UNIT
Fino a 31 Centrali LG per un totale di 3968 apparecchi comandati / Up to 31 LG control units for a total of 3968 controlled luminaires

Cod. **12131C**

SCHEMA DI INTEGRAZIONE IN NUBE DI IMPIANTI LG CONNECT CON IMPIANTI LG DI VECCHIA GENERAZIONE NUBE INTEGRATION SCHEME FOR LG CONNECT SYSTEMS WITH OLDER GENERATION LG SYSTEMS

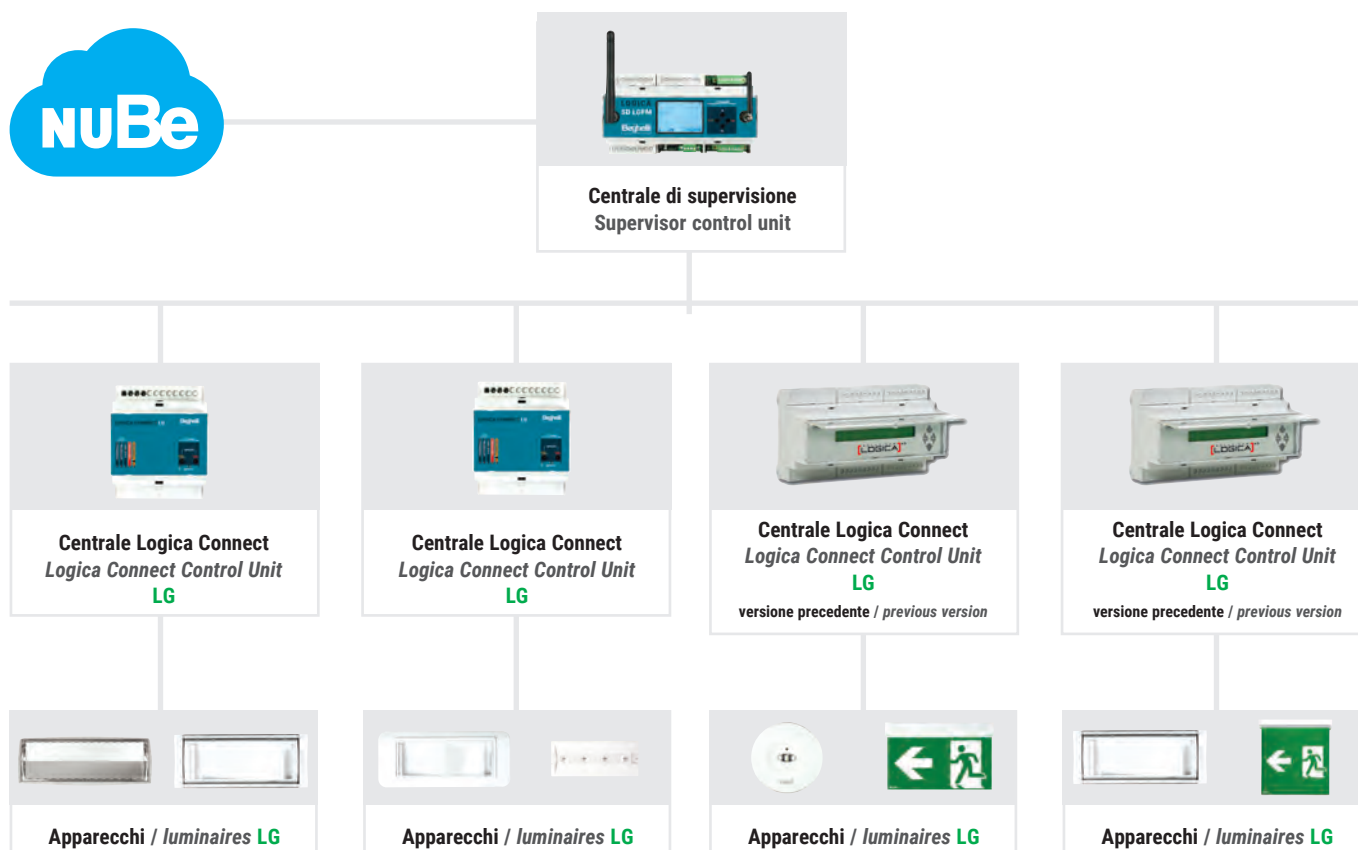



Caratteristiche

Alimentazione 230Vac $\pm 10\%$, 50÷60Hz

Installazioni su barra DIN 9 moduli

Apparecchi gestiti fino a 996 dispositivi radio gestibili tra lampade di illuminazione, di emergenza e dispositivi domotici.

Interfaccia di collegamento

Radio Spread Spectrum SFH DSSS su 16 canali, UMTS 4G slot mini SD (SIM inclusa), WiFi - modalità AccesPoint (AP) e modalità Client (STA), Ethernet, USB (2 porte), Bluetooth, RS485, RS232, 4 porte IN e 2 porte OUT

Software di gestione

App B.connect, NuBe, SD Manager, Logica visual

Scheda di memoria

SD Card (non inclusa)

Conformità EN60950-1, EN62034, EN50172, 2014/53/UE

Applicazioni

Industriale, terziario

Characteristics

Power supply 230VAC $\pm 10\%$, 50÷60Hz

Mounting 9 DIN rail modules

Managed luminaires up to 996 manageable radio devices including lighting lamps, emergency lamps and home automation devices.

Connection interface

SFH DSSS Radio Spread Spectrum on 16 channels, UMTS 4G slot mini SD (SIM included), WiFi - AccesPoint (AP) mode and Client (STA) mode, Ethernet, USB (2 ports), Bluetooth, RS485, RS232, 4 x IN ports and 2 x OUT ports

Management software

B.connect App, NuBe, SD Manager, Logica visual

Memory card

SD Card (not included)

Compliance EN60950-1, EN62034, EN50172, 2014/53/EU

Applications

Industry, service sectors

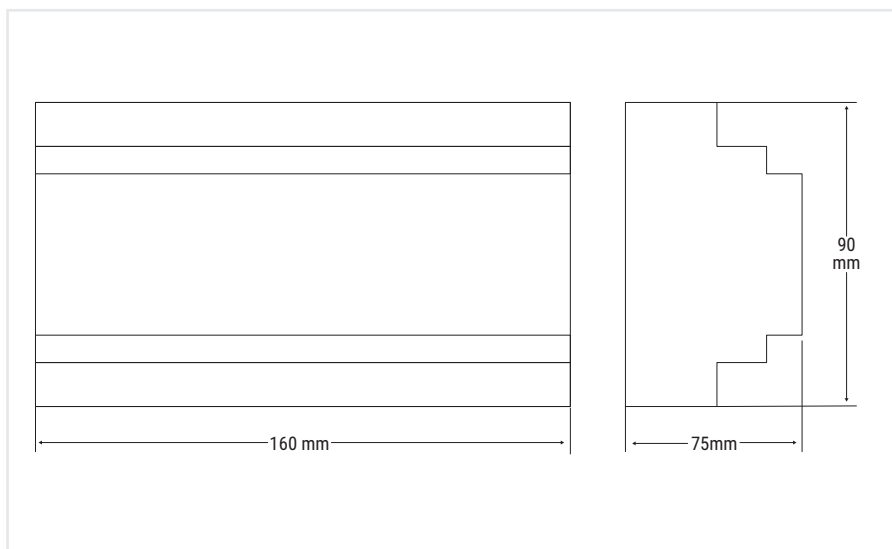

SD LGFM

FUNZIONI

- Gestione e diagnostica di tutte le funzioni di emergenza
- Sincronizzazione e temporizzazione delle funzioni di test
- Test alternati (pari/dispari) garantendo il 50% dell'impianto attivo
- Gestione dettagliata degli errori
- Inibizione/abilitazione dell'emergenza
- Configurazione dell'impianto di illuminazione e creazione di scenari luminosi, accensione spegnimento programmati
- Impostazione del livello di dimmer e della luminosità
- Misurazione dell'energia consumata e risparmiata

COMUNICAZIONE RADIO SFH DSS A PORTATA RADIO ILLIMITATA

Le onde radio utilizzate dal sistema LGFM sono a bassissima potenza per evitare interferenza e inquinamento elettromagnetico (secondo Raccomandazione europea ERC/REC 70-03). Il segnale trasmesso dalla Centrale viene ricevuto dal primo apparecchio che, essendo dotato di ricetrasmittitore e amplificatore radio, trasmette il segnale all'apparecchio che lo segue creando una **rete magliata con una portata radio pressochè illimitata.**

FUNCTIONS

- Management and diagnostics of all emergency functions
- Synchronization and timing of test functions
- Alternate tests (even/odd) guaranteeing 50% of the active system
- Detailed error handling
- Emergency inhibition/enabling
- Configuration of the lighting system and creation of light scenarios, programmed switching on and off
- Setting the dimmer level and brightness
- Measurement of energy consumed and saved

SFH DSS RADIO COMMUNICATIONS WITH UNLIMITED RADIO RANGE

The radio waves Logica FM system are very low power to avoid interference and electromagnetic pollution (according to European Recommendation ERC/REC 70-03). The signal transmitted by the control unit is received by the near luminaires which, being equipped with a transceiver and radio amplifier, transmits the signal to the next luminaires, creating a **mesh network with an almost unlimited radio range.**

	Cod.	Descrizione Description	Numero apparecchi Number of luminaires	Numero moduli in barra DIN Number of DIN rail modules
CT	SD LGFM			
	21102	CENTRALE LOGICA SD LGFM (SIM inclusa)	996	9

Moduli di sistema / System modules



MODULO LG / LG MODULE

Permette l'espansione dell'apparecchio per il dialogo, tramite BUS Logica, con la Centrale di controllo Logica LG
It allows the expansion of the device for dialogue, via the Logica BUS, with the Logica LG Control Unit.

MODULO LGFM / LGFM MODULE

Modulo ricetrasmittente per il collegamento radio fra apparecchi e Centrali di controllo Logica SD LGFM e Logica Connect LGFM
Transceiver module for the radio connection between devices and Logica SD LGFM and Logica Connect LGFM control units

MODULO DALI / DALI MODULE

Permette l'espansione dell'apparecchio per il dialogo, tramite BUS DALI, con centrali dotate di trasmissione dati DALI
It allows luminaire expansion for dialogue via DALI BUS with various control units equipped with DALI data transmission.

	Cod.	Descrizione Description	Grado di protezione IP IP protection rating
CT	LG		
	15036	MODULO LG	IP20
	LGFM		
	15037	MODULO LGFM	IP20
	15049	MODULO LGFM IP65	IP65
	19375**	MODULO LGFM INVERTER	IP20
DALI			
	15038	MODULO DALI	IP20

** Da abbinare ad INVERTER / To be combined with INVERTER (19355L, 19391)

CT

CTS

Centrale supervisione / Co

emergenza / emergency

WEB
CATALOGUE

LG

LG EPS

31
Centrali

IP20

GSM

WiFi

GPRS

+40°C
-20°C**Caratteristiche****Alimentazione** 230Vac $\pm 10\%$, 50÷60Hz**Installazioni** su barra DIN 9 moduli**Centrali gestite** Comanda e supervisiona via bus RS485 fino a 31 Centrali LG o LG EPS)**Interfaccia di collegamento**

UMTS 4G slot mini SD, WiFi - modalità AccesPoint (AP) e modalità Client (STA), Ethernet, USB (2 porte), Bluetooth, RS485, RS232, 4 porte IN e 2 porte OUT

Software di gestione

NuBe, Logica visual

Scheda di memoria

SD Card (non inclusa)

Conformità EN60950-1, EN62034, EN50172, 2014/53/UE**Applicazioni**

Industriale, terziario

Characteristics**Power supply** 230VAC $\pm 10\%$, 50÷60Hz**Mounting** 9 DIN rail modules**Managed Control unit** Commands and supervises via RS485 bus up to 31 LG control units (Cod. 12100C) or LG EPS LOG control units (Cod. 16322),**Connection interface**

UMTS 4G slot mini SD, WiFi - AccesPoint (AP) mode and Client (STA) mode, Ethernet, USB (2 ports), Bluetooth, RS485, RS232, 4 x IN ports and 2 x OUT ports

Management software

NuBe, Logica visual

Memory card

SD Card (not included)

Compliance EN60950-1, EN62034, EN50172, 2014/53/EU**Applications**

Industry, service sectors

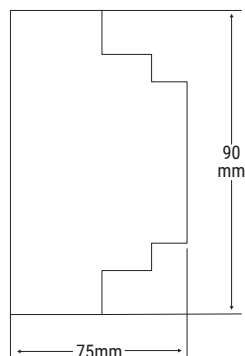
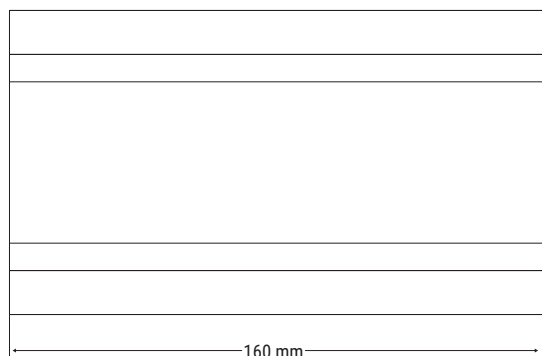

Control Unit Logica LG - LG EPS

FUNZIONI LG EPS

- Comando e supervisione fino a 31 centrali LG EPS via bus RS485 (Cod. 16322)
- Gestione e diagnostica di tutte le funzioni di emergenza
- Sincronizzazione e temporizzazione delle funzioni di test

LG EPS FUNCTIONS

- Commands and supervises via RS485 bus up to 31 LG EPS control units (Cod. 16322)
- Management and diagnostics of all emergency functions
- Synchronization and timing of test functions

FUNZIONI LG

- Comando e supervisione fino a 31 centrali LG via bus RS485 (Cod. 12100)
- Integrazione su Cloud NuBe di Centrali LG di vecchia generazione per la creazione di un unico impianto

LG FUNCTIONS

- Commands and supervises via RS485 bus up to 31 LG control units (Cod. 12100C)
- Integration with previous generation LG control units on NuBe Cloud for the creation of a only system

	Cod.	Descrizione Description	Numero centrali Control Unit Number	Numero apparecchi Luminaires number	Numero moduli in barra DIN Number of DIN rail modules
CT	LG				
	12131C	CENTRALE SUPERVISIONE	31 (LG)	1984	9
CTS	LG EPS				
	12131C	CENTRALE SUPERVISIONE	31 (LG EPS ECO / EPS PRO)	1984	9

SCHEMA DI INTEGRAZIONE IN NUBE DI IMPIANTI LG CONNECT CON IMPIANTI LG DI VECCHIA GENERAZIONE NUBE INTEGRATION SCHEME FOR LG CONNECT SYSTEMS WITH PREVIOUS GENERATION LG SYSTEMS

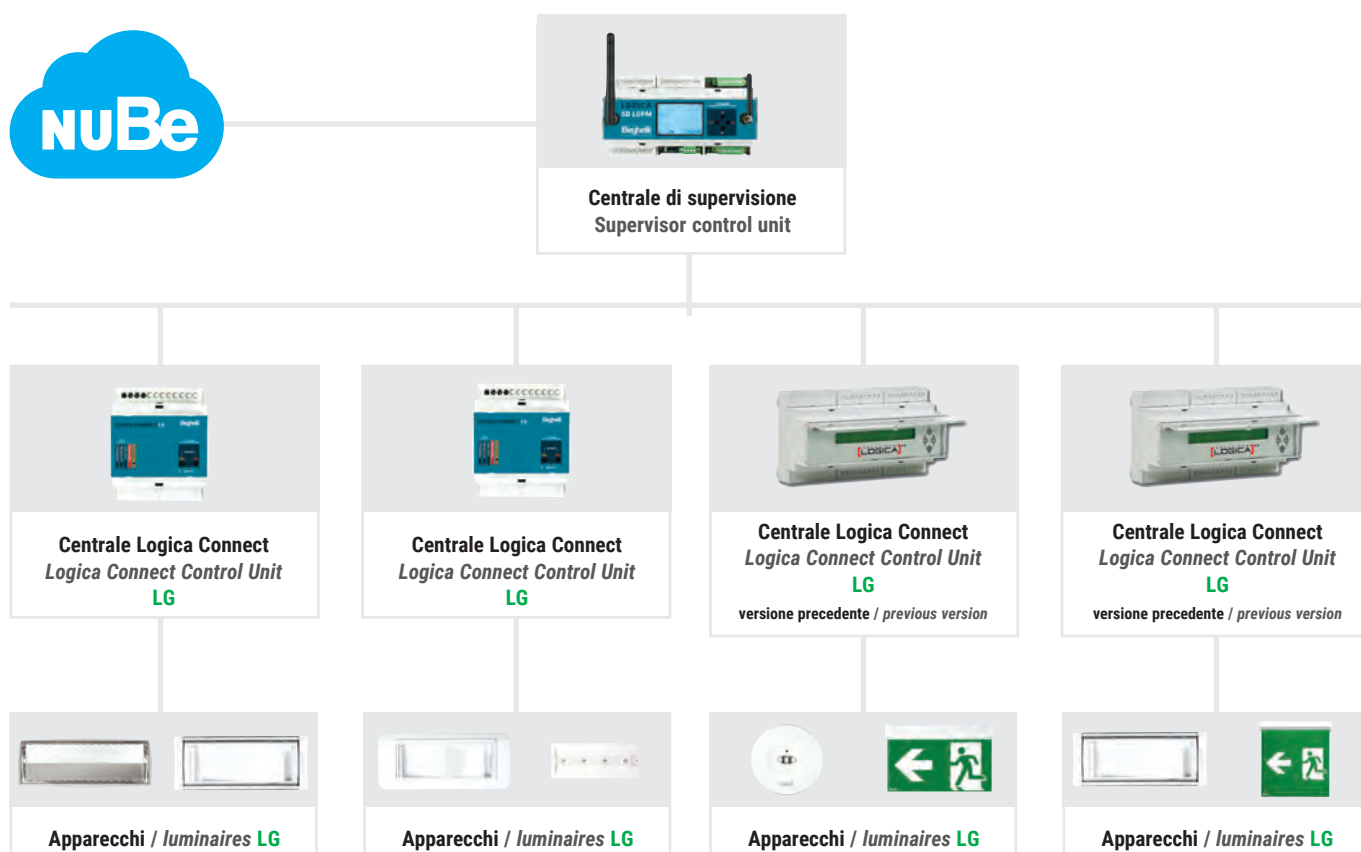

Telecomando Inibit / Inibit remote

emergenza / emergency



WEB
CATALOGUE



TR-AT

LG

Versione RM
100
DISPOSITIVI

Versione LG
128
DISPOSITIVI

IP20

+40°C
-20°C

Caratteristiche

Alimentazione 230Vac $\pm 10\%$, 50÷60Hz

Installazione su barra DIN 4/6 moduli

Dotazioni batteria anti blackout

Apparecchi gestiti fino a 128 dispositivi nella versione LG, fino a 100 dispositivi nella versione RM (suddivisi su 2 linee 50+50)

Interfaccia di collegamento

WiFi - modalità AccesPoint (AP) e modalità Client (STA) (solo versione LG)

Software di gestione

App B.connect, NuBe (solo versione LG)

Conformità EN60950-1, EN62034, EN50172, 2014/53/UE

Applicazioni

Industriale, terziario

Characteristics

Power supply 230VAC $\pm 10\%$, 50÷60Hz

Mounting 4/6 DIN rail modules

Equipment anti-blackout battery

Managed luminaires up to 128 devices in the LG version, up to 100 devices in the RM version (split over 2 lines 50+50)

Connection interface

WiFi - AccesPoint (AP) mode and Client (STA) mode, Bluetooth (not enabled)

Management software

B.connect App, NuBe (LG version only)

Compliance EN60950-1, EN62034, EN50172, 2014/53/EU

Applications

Industry, service sectors

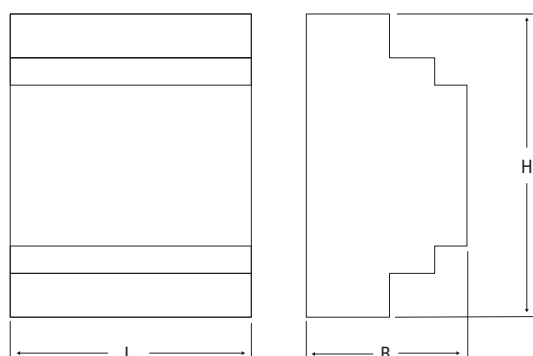

Versione Version	Dimensioni Dimensions mm		
	L	B	H
TR-AT	150	70	90
LG	71	60	90

control



TELECOMANDO INIBIT RM / RM INIBIT REMOTE CONTROL



TELECOMANDO INIBIT LG / LG INIBIT REMOTE CONTROL

	Cod.	Descrizione Description	Numero apparecchi Number of luminaires	Autonomia	Installazione
TR-AT	2730	INIBIT 973 COMANDO R.MODE	100	500 attivazioni	Guida DIN
CT	12101	TELECOMANDO LOGICA LG	128	500 attivazioni	Guida DIN



Sistema di alimentazione centralizzata per illuminazione di emergenza con funzioni di diagnosi e test automatici di funzionamento e di autonomia. Ogni apparecchio esegue la diagnostica secondo la Norma UNI 11222 e dialoga in modalità criptata, con la Centrale utilizzando le linee di alimentazione per lo scambio delle informazioni. Il sistema permette un impianto misto LG230 e LG24. Inoltre è possibile collegare apparecchi, già utilizzati per l'illuminazione ordinaria, in emergenza con l'inserimento del Modulo lampada.

Centralized power supply for emergency lighting with diagnosis functions and automatic operation and autonomy tests. Each luminaire communicates in encrypted mode with the control unit using the power lines to exchange information. The system allows a mixed LG230 and LG24 system. Furthermore, it is possible to connect devices already used for ordinary lighting in an emergency by inserting the specific lamp module.

Conformità / Compliance

2014/35/EU, EN50171, EN62485-2, EN62034, EN62040-1, EN50172, UNI11222

CENTRALI E SOTTOCENTRALI DI CONTROLLO / MAIN-STATION AND SUBSTATION

La Centrale di controllo LG230 è disponibile in molte configurazioni che variano dalla versione più piccola ST5, alla più grande ST24. Inoltre, si possono effettuare composizioni personalizzate seguendo una specifica codifica modulare che consente di realizzare il proprio sistema su misura. Ogni Centrale è integrata in un armadio in metallo che contiene tutti i componenti e, in caso di impianti complessi, è possibile effettuare un frazionamento per mezzo delle apposite Sottocentrali.

The LG230 Main-station is available in many configurations ranging from the smallest ST5 version to the largest ST24. Furthermore, customized compositions can be made following a specific modular coding that allows you to create your own tailor-made system. Each Main-station is integrated into a metal cabinet which contains all the components and, in the case of complex systems, it is possible to carry out a subdivision using the appropriate Substation.

CENTRALI LG230 / MAIN STATION LG230

SOTTOCENTRALI LG230 / SUBSTATION LG230

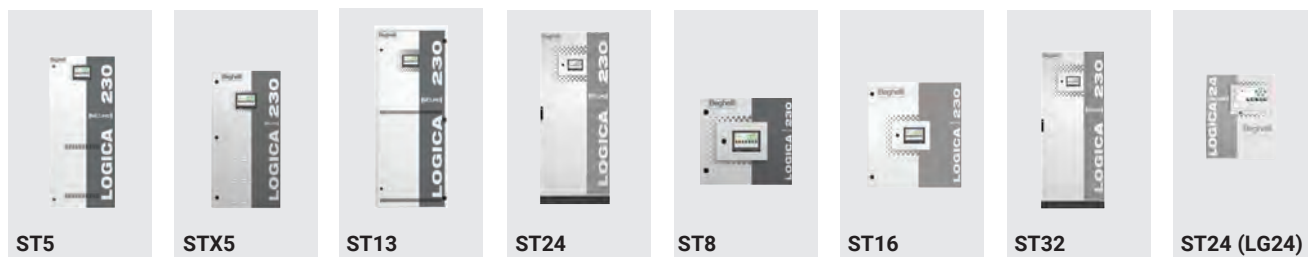

FUNZIONI

- Controllo e monitoraggio di apparecchi di emergenza sulla stessa linea ma con differente modo di funzionamento.
- Modalità SE con switch da comando esterno in modalità SA
- Moduli di monitoraggio per l'attivazione selettiva dell'emergenza
- Ingressi ausiliari per l'attivazione selettiva delle varie funzioni
- Riconoscimento automatico linee e moduli di controllo lampada
- Monitoraggio individuale di 32 apparecchi per linea
- Esecuzione automatica dei test funzionali e di autonomia
- Report automatico dei test eseguiti
- Memorizzazione degli eventi per due anni (LOG-BOOK)

MODULARITÀ E SICUREZZA

Ogni Centrale LG230, dispone di un numero di linee variabile in grado di controllare fino a 32 apparecchi. Possibilità di suddividere l'alimentazione dell'illuminazione di emergenza su più uscite, tutte protette singolarmente, per un nuovo concetto di sicurezza nel pieno rispetto delle normative del settore.

FUNCTIONS

- Control and monitoring of emergency luminaires on the same line but with different operating modes.
- SE mode with switch from external command to SA mode
- Monitoring modules for selective emergency activation
- Auxiliary inputs for selective activation of the various functions
- Automatic recognition of lines and lamp control modules
- Individual monitoring of 32 luminaires per line
- Automatic execution of functional and autonomy tests
- Automatic report of tests performed.
- Recording of events for two years (LOG-BOOK)

MODULARITY AND SAFETY

Each LG230 control unit has a variable number of lines capable of controlling up to 32 devices. Possibility of dividing the emergency lighting power supply onto multiple outputs, all individually protected, for a new safety concept in full compliance with sector regulations.

SUPER SICUREZZA CON IL MODULO DRM / HIGH SECURITY WITH THE DRM MODULE

DRM

AUTORIPARA

Modulo opzionale dotato di batteria locale per apparecchi LG230: in caso di interruzione delle linee che alimentano gli apparecchi di emergenza, DRM interviene garantendo l'illuminazione di emergenza in qualsiasi caso. / *Optional module equipped with local battery for LG230 luminaires: in the event of an interruption in the lines that power the emergency luminaires, DRM intervenes, guaranteeing emergency lighting in any case.*

ALIMENTAZIONE di rete
POWER SUPPLY
230V-50Hz

BLACKOUT
alimentazione
di rete / power supply
mains

EVENTO DISASTROSO
DISASTER EVENT
con interruzione delle
linee di alimentazione
del soccorritore / with
the cut out of the supply
lines of the emergency
power supply unit

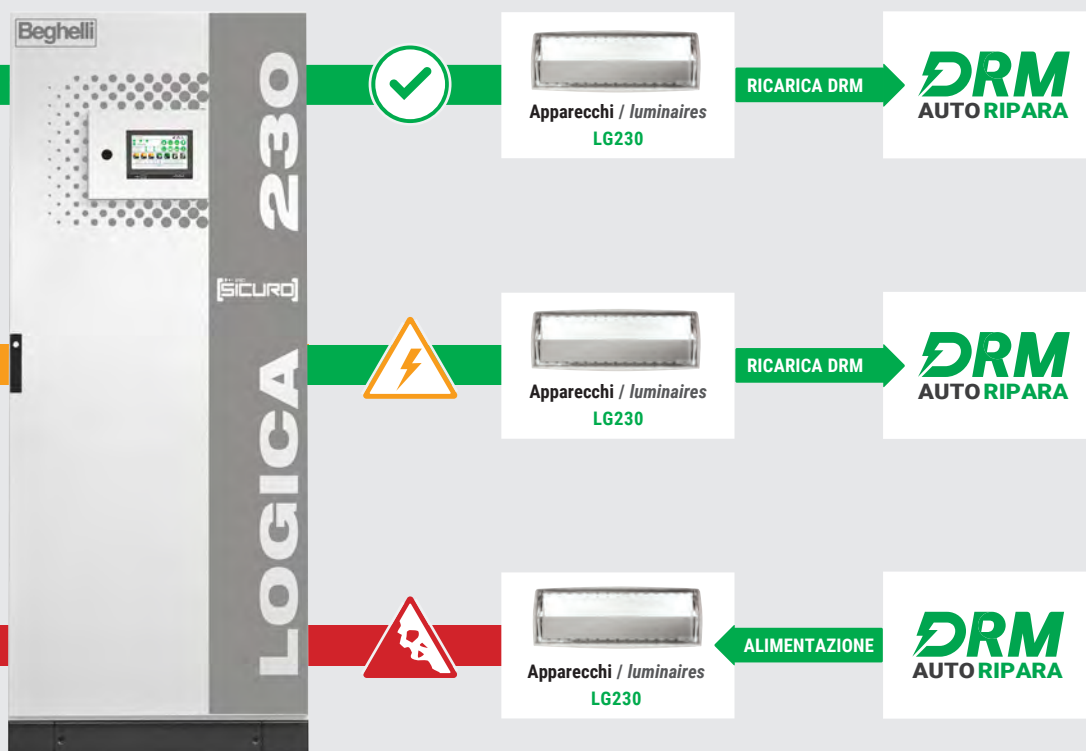

SEGUE / NEXT >

LG230 - LG24: ESPRESSIONE DI PURA FUNZIONALITÀ

LOGICA 230/24 si integra facilmente in sistemi BMS (Building Management System) e assicura grande versatilità del sistema in quanto permette la composizione di un impianto misto composto da moduli a 230V (LG230) e moduli a 24V (LG24), anche in modalità dinamica e lampare per l'illuminazione ordinaria, con l'inserimento del Modulo lampada. Ogni apparecchio è in grado di dialogare individualmente con la centrale utilizzando le linee di alimentazione per lo scambio delle informazioni per mezzo di tecnologia digitale ad onde convogliate. Con questa tecnologia si limitano le connessioni e i cavi di installazione con evidente risparmio di materiale e manodopera.

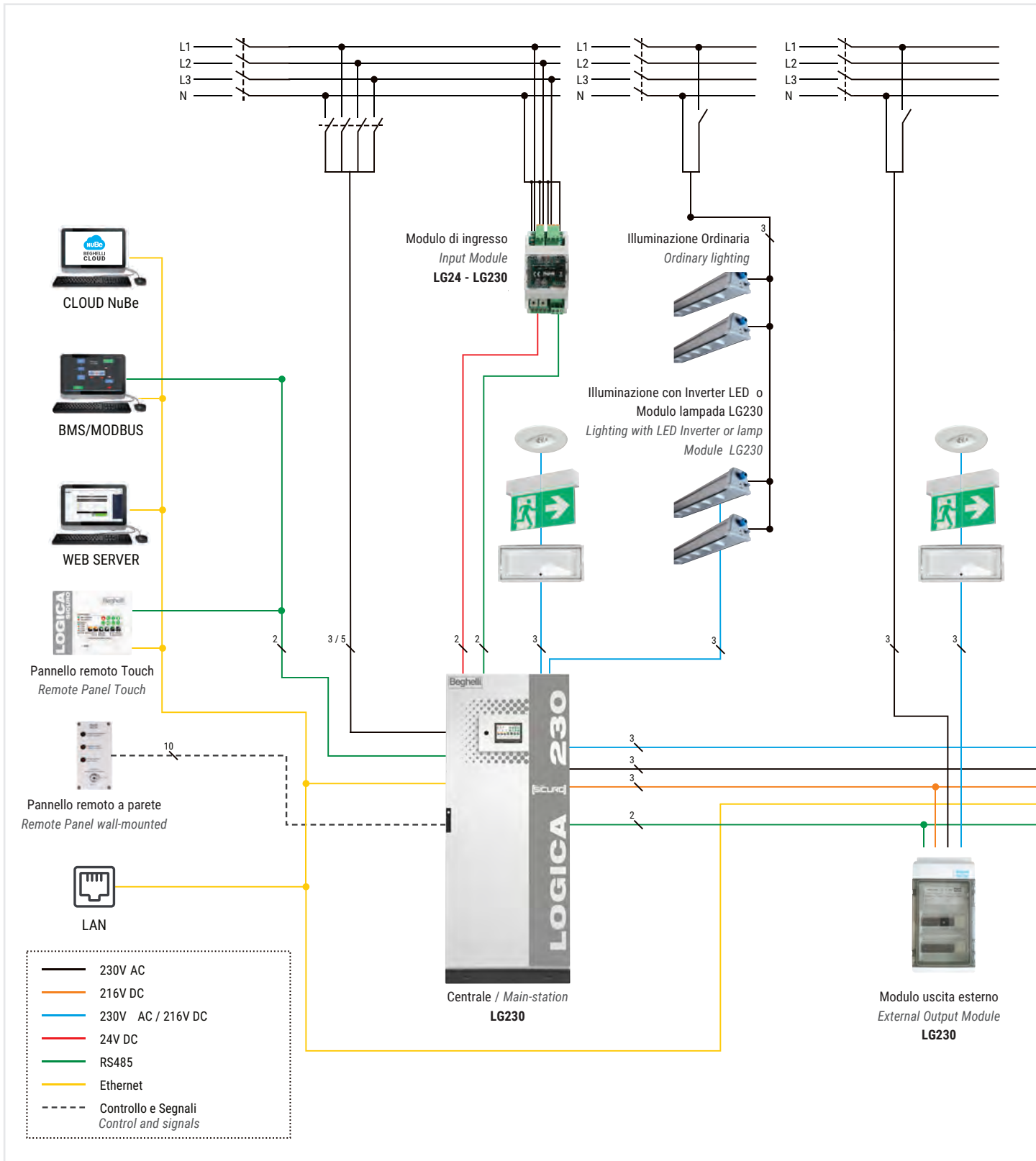

LG230 - LG24: PURE FUNCTIONALITY EXPRESSION

LOGICA 230/24 can be easily integrated into BMS (Building Management System) systems and ensures great versatility of the system as it allows the composition of a mixed system made up of 230V modules (LG230) and 24V modules (LG24) and lamp for ordinary lighting, with the insertion of the lamp module. Each device is able to communicate individually with the control unit using the power lines to exchange information by means of digital power line technology. With this technology, connections and installation cables are limited with evident savings in material and labor.

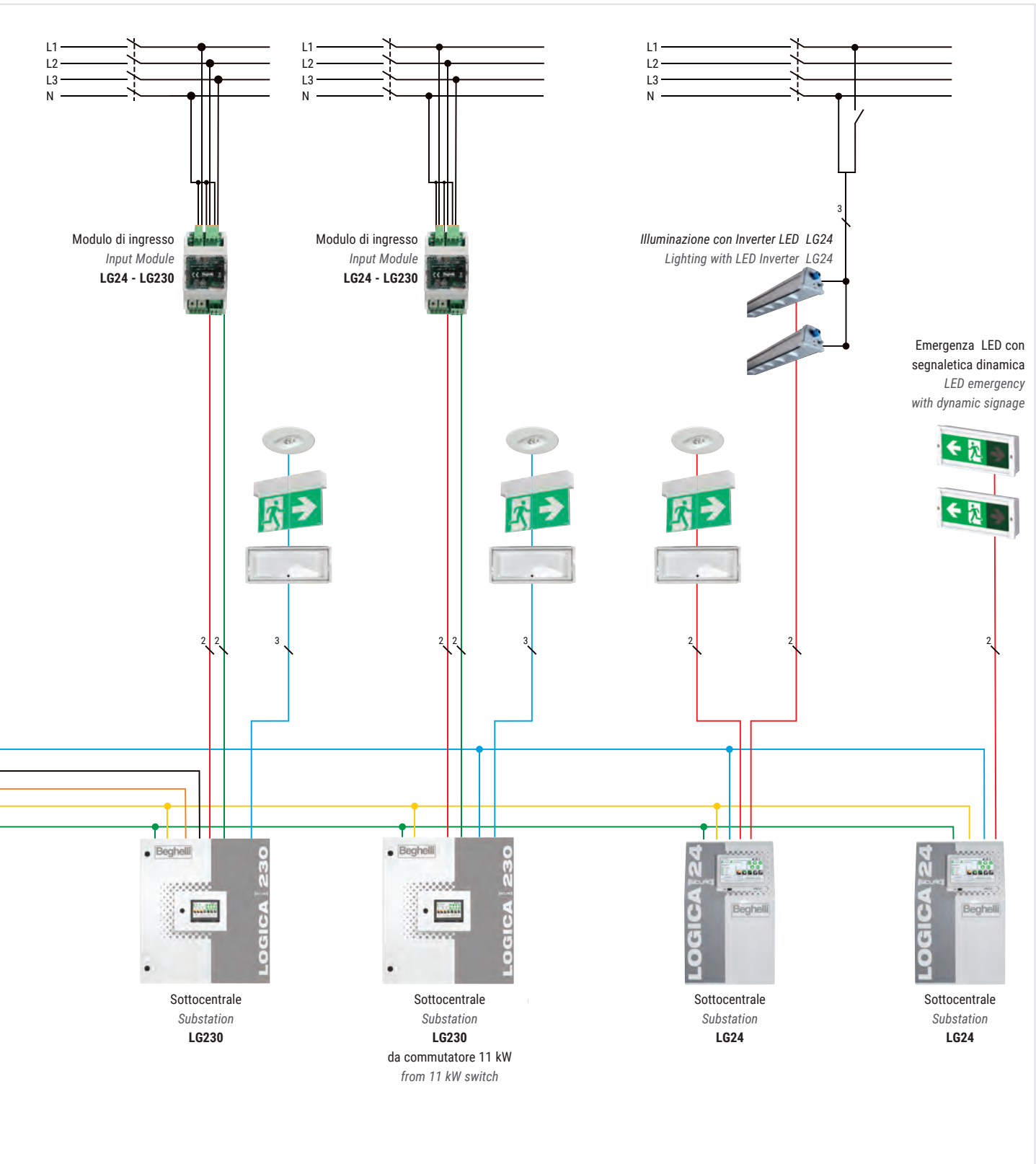

SCELTA E CODIFICA DELLA CENTRALE / CHOICE AND CODING OF THE MAIN - STATION

Tutte le composizioni fuori standard hanno una codifica componibile che si basa sul Cod. per identificare tutti i moduli aggiuntivi:
 All special compositions have a modular coding which is based on the Order Code. to identify all additional modules:



Codifica estesa della Centrale

- codice della Centrale LG230 da integrare con i dispositivi necessari per l'impianto
- numero di Moduli di uscita da 1, 2 o 4 circuiti
- numero di Moduli di ingresso 230V o per contatti puliti
- numero di Sottocentrali o Moduli di uscita esterni derivati dalla Centrale principale

Main - station extended coding

- code of the LG230 control unit to be integrated with the devices necessary for the system
- number of output modules with 1, 2 or 4 circuits
- number of 230V input modules or for dry contacts
- number of sub-panels or external output modules derived from the main control panel

Cod. Centrale
Main-station

17 ___

Numero totale
Total number

-1 / -2 / -4

U

Numero totale
Total number

I / IC

/ K

Numero totale
Total number

S

Numero totale
Total number

U = Moduli di uscita / *Output Modules:*

1U = 1X32 (Cod. 17233)

2U = 2X32 (Cod. 17232)

4U = 4X32 (Cod. 17234)

I = Moduli di Ingresso / *Input Modules:*

I = 230V (Cod.17230)

IC = 24V (Cod.17231)

K = Moduli di uscita esterni / *External Output Modules (AK)*

S = Uscite per sottostazioni / *Outputs for substation*



SCELTA E CODIFICA DELLA SOTTOCENTRALE / CHOICE AND CODING OF SUBSTATION UNIT

Tutte le composizioni fuori standard hanno una codifica componibile che si basa sul Cod. per identificare tutti i moduli aggiuntivi:
All special compositions have a modular coding which is based on the Order Code. to identify all additional modules:



Codifica estesa della Sottocentrale

- codice della Sottocentrale LG230 da integrare con i dispositivi necessari per l'impianto
- numero di Moduli di uscita da 1, 2 o 4 circuiti
- numero di Moduli di ingresso 230V

Substation extended coding

- code of the LG230 Substation to be integrated with the devices necessary for the system
- number of output modules with 1, 2 or 4 circuits
- number of 230V input modules

Cod. Sottocentrale Substation	Numero totale Total number		Numero totale Total number		Numero totale Total number
17 ---	-1 / -2 / -4	U	---	I / IC	---
				/ K	---

U = Moduli di uscita / *Output Modules*:
1U = 1X32 (Cod. 17233)
2U = 2X32 (Cod. 17232)
4U = 4X32 (Cod. 17234)

I = Moduli di Ingresso / *Input Modules*:
I = 230V (Cod.17230)
IC = 24V (Cod.17231)

K = Moduli di uscita esterni / *External Output Modules (AK)*

CENTRALE ST5 LG230 / MAIN - STATION ST5 LG230



Centrale di controllo LOGICA 230 ST5 (5 slot) è integrata all'interno di un armadio in metallo che contiene tutti i componenti del sistema e i gruppi batterie. Ogni centrale dispone di un numero di Moduli, in uscita e in ingresso, variabile a seconda del modello. Ogni modulo di uscita è suddiviso su 1, 2 o 4 linee, ciascuna in grado di controllare fino a 32 apparecchi per un massimo di 1380W per versione 1x, 690W per versione 2x, 345W per versione 4x ogni linea. La Centrale LOGICA 230 ST5 dispone di un display touch grafico 7" montato a bordo porta e moduli di uscita con cestelli a 19", le batterie sono alloggiare direttamente nella parte inferiore dell'armadio della Centrale.

The LOGICA 230 ST5 Main - station (5 slots) is integrated into a metal cabinet that contains all system components and battery packs. Each Main - station has a variable number of Output and Input Modules, depending on the model. Each output module is divided into 1, 2 or 4 lines, each capable of controlling up to 32 luminaires for a maximum of 1380W for 1x version, 690W for 2x version, 345W for 4x version each line. The LOGICA 230 ST5 Main - station has a 7" graphic touch screen display mounted on the door and output modules with 19" housings, the batteries are housed directly in the lower part of the Main - station cabinet.

	Cod.	Descrizione Description	Autonomia Autonomy h	Moduli Modules OUT*	Moduli Modules IN**	Batteria Battery	Potenza W Power W		Peso Weight Kg	
							Nominale*** Nominal***	Max EN50171		
CTS	LG230									
	17601	CENTRALE ST5 S230 7Ah 1P	1h	0	0	18 x (12 V 7 Ah)	942	707	109	
	17602	CENTRALE ST5 S230 7Ah 2P	2h	0	0	18 x (12 V 7 Ah)	534	401	109	
	17603	CENTRALE ST5 S230 7Ah 3P	3h	0	0	18 x (12 V 7 Ah)	372	279	109	
	17604	CENTRALE ST5 S230 12Ah 1P	1h	0	0	18 x (12 V 12 Ah)	1614	1211	135	
	17605	CENTRALE ST5 S230 12Ah 2P	2h	0	0	18 x (12 V 12 Ah)	916	687	135	
	17606	CENTRALE ST5 S230 12Ah 3P	3h	0	0	18 x (12 V 12 Ah)	637	478	135	

* Moduli espandibili fino a 5 slot - ** Moduli IN integrati espandibili fino a 2 - Moduli IN esterni espandibili fino a 96 - *** 20° ambiente

* Modules expandable up to 5 slots - ** Built-in IN modules expandable up to 2 / External IN modules expandable up to 96 - *** 20° environment

CENTRALE STX5 LG230 / MAIN - STATION STX5 LG230



Centrale di controllo LOGICA 230 STX5 (5 slot) è integrata all'interno di un armadio in metallo che contiene tutti i componenti del sistema e i gruppi batterie. Ogni centrale dispone di un numero di Moduli, in uscita e in ingresso, variabile a seconda delle esigenze di impianto, max 5 slot. Ogni modulo di uscita è suddiviso su 1, 2 o 4 linee, ciascuna in grado di controllare fino a 32 apparecchi per un massimo di 1380W per versione 1x, 690W per versione 2x, 345W per versione 4x ogni linea. La Centrale LOGICA 230 Mini dispone di un display touch grafico 7" montato a bordo porta e moduli di uscita con cestelli a 19", le batterie sono alloggiare direttamente nella parte inferiore dell'armadio della Centrale.

The LOGICA 230 ST5 Main-station (5 slots) is integrated into a metal cabinet that contains all system components and battery packs. Each Main-station has a variable number of Output and Input Modules, depending on system requirements, max. 5 slots. Each output module is divided into 1, 2 or 4 lines, each capable of controlling up to 32 luminaires for a maximum of 1380W for 1x version, 690W for 2x version, 345W for 4x version each line. The LOGICA 230 Mini Main-station has a 7" graphic touch screen display mounted on the door and output modules with 19" housings, the batteries are housed directly in the lower part of the Main-station cabinet.

Cod.	Descrizione Description	Autonomia Autonomy h	Moduli Modules OUT*	Moduli Modules IN**	Batteria Battery	Potenza W Power W		Peso Weight Kg
						Nominale*** Nominal***	Max EN50171	
LG230								
17610	CENTRALE STX5 S230 12Ah 1P	1h	0	0	18 x (12 V 12 Ah)	1614	1211	158
17611	CENTRALE STX5 S230 12Ah 2P	2h	0	0	18 x (12 V 12 Ah)	916	687	158
17612	CENTRALE STX5 S230 12Ah 3P	3h	0	0	18 x (12 V 12 Ah)	637	478	158
17613	CENTRALE STX5 S230 20Ah 1P	1h	0	0	18 x (12 V 20 Ah)	2635	1976	189
17614	CENTRALE STX5 S230 20Ah 2P	2h	0	0	18 x (12 V 20 Ah)	1501	1126	189
17615	CENTRALE STX5 S230 20Ah 3P	3h	0	0	18 x (12 V 20 Ah)	1043	782	189
17616	CENTRALE STX5 S230 28Ah 1P	1h	0	0	18 x (12 V 28 Ah)	3607	2705	243
17617	CENTRALE STX5 S230 28Ah 2P	2h	0	0	18 x (12 V 28 Ah)	2069	1552	243
17618	CENTRALE STX5 S230 28Ah 3P	3h	0	0	18 x (12 V 28 Ah)	1441	1081	243

* Moduli espandibili fino a 5 slot - ** Moduli IN integrati espandibili fino a 2 - Moduli IN esterni espandibili fino a 96 - *** 20° ambiente

* Modules expandable up to 5 slots - ** Built-in IN modules expandable up to 2 / External IN modules expandable up to 96 - *** 20° environment

CENTRALE ST13 LG230 / ST13 LG230 MAIN - STATION



Centrale di controllo LOGICA 230 ST13 (13 slot) è integrata all'interno di un armadio in metallo che contiene tutti i componenti del sistema e i gruppi batterie. Ogni centrale dispone di un numero di Moduli, in uscita e in ingresso, variabile a seconda delle esigenze di impianto, max 13 slot. Ogni modulo di uscita è suddiviso su 1, 2 o 4 linee, ciascuna in grado di controllare fino a 32 apparecchi per un massimo di 1380W per versione 1x, 690W per versione 2x, 345W per versione 4x ogni linea. La Centrale LOGICA 230 ST13 dispone di un display touch grafico 7" montato a bordo porta e moduli di uscita con cestelli a 19", le batterie sono alloggiare direttamente nella parte inferiore dell'armadio della Centrale.

The LOGICA 230 ST13 Main - station (13 slots) is integrated into a metal cabinet that contains all system components and battery packs. Each Main-station has a variable number of Output and Input Modules, depending on system requirements, max. 13 slots. Each output module is divided into 1, 2 or 4 lines, each capable of controlling up to 32 luminaires for a maximum of 1380W for 1x version, 690W for 2x version, 345W for 4x version each line. The LOGICA 230 ST13 Main-station has a 7" graphic touch screen display mounted on the door and output modules with 19" housings, the batteries are housed directly in the lower part of the Main - station cabinet.

Cod.	Descrizione Description	Autonomia Autonomy h	Moduli Modules OUT*	Moduli Modules IN**	Batteria Battery	Potenza W Power W		Peso Weight Kg
						Nominale*** Nominal***	Max EN50171	
LG230								
17620	CENTRALE S230 20Ah 1P	1h	0	0	18 x (12 V 20 Ah)	2635	1976	255
17621	CENTRALE S230 20Ah 2P	2h	0	0	18 x (12 V 20 Ah)	1501	1126	255
17622	CENTRALE S230 20Ah 3P	3h	0	0	18 x (12 V 20 Ah)	1043	782	255
17623	CENTRALE S230 28Ah 1P	1h	0	0	18 x (12 V 28 Ah)	3607	2705	309
17624	CENTRALE S230 28Ah 2P	2h	0	0	18 x (12 V 28 Ah)	2069	1552	309
17625	CENTRALE S230 28Ah 3P	3h	0	0	18 x (12 V 28 Ah)	1441	1081	309
17626	CENTRALE S230 33Ah 1P	1h	0	0	18 x (12 V 33 Ah)	4706	3530	358
17627	CENTRALE S230 33Ah 2P	2h	0	0	18 x (12 V 33 Ah)	2462	1847	358
17628	CENTRALE S230 33Ah 3P	3h	0	0	18 x (12 V 33 Ah)	1771	1328	358
17629	CENTRALE S230 45Ah 1P	1h	0	0	18 x (12 V 45 Ah)	5789	4342	408
17630	CENTRALE S230 45Ah 2P	2h	0	0	18 x (12 V 45 Ah)	3370	2528	408
17631	CENTRALE S230 45Ah 3P	3h	0	0	18 x (12 V 45 Ah)	2419	1814	408
17632	CENTRALE S230 55Ah 1P	1h	0	0	18 x (12 V 55 Ah)	7625	5719	462
17633	CENTRALE S230 55Ah 2P	2h	0	0	18 x (12 V 55 Ah)	4104	3078	462
17634	CENTRALE S230 55Ah 3P	3h	0	0	18 x (12 V 55 Ah)	2959	2219	462
17635	CENTRALE S230 70Ah 1P	1h	0	0	18 x (12 V 70 Ah)	10174	7631	606
17636	CENTRALE S230 70Ah 2P	2h	0	0	18 x (12 V 70 Ah)	5594	4196	606
17637	CENTRALE S230 70Ah 3P	3h	0	0	18 x (12 V 70 Ah)	4039	3029	606
17638	CENTRALE S230 90Ah 1P	1h	0	0	18 x (12 V 90 Ah)	10822	8117	637
17639	CENTRALE S230 90Ah 2P	2h	0	0	18 x (12 V 90 Ah)	6718	5039	637
17640	CENTRALE S230 90Ah 3P	3h	0	0	18 x (12 V 90 Ah)	4860	3645	637
17641	CENTRALE S230 100Ah 1P	1h	0	0	18 x (12 V 100 Ah)	14148	10611	740
17642	CENTRALE S230 100Ah 2P	2h	0	0	18 x (12 V 100 Ah)	7841	5881	740
17643	CENTRALE S230 100Ah 3P	3h	0	0	18 x (12 V 100 Ah)	5659	4244	740

* Moduli espandibili fino a 13 slot - ** Moduli IN integrati espandibili fino a 4 / Moduli IN esterni espandibili fino a 96 - *** 20° ambiente

CTS

CENTRALE ST24 LG230 / ST24 LG230 MAIN - STATION



La Centrale di controllo ST24 (24 slot) è integrata all'interno di un armadio in metallo che contiene tutti i componenti del sistema. E' previsto un secondo armadio che contiene i gruppi batterie. Ogni Centrale, dispone di un numero di Moduli in uscita, e in entrata, variabile a seconda delle esigenze di impianto, max 24 slot. Ogni modulo di uscita è suddiviso su 1, 2 o 4 linee, ciascuna in grado di controllare fino a 32 apparecchi per un massimo di 1380W per versione 1x, 690W per versione 2x, 345W per versione 4x ogni linea.

La Centrale ST24 dispone di un display touch grafico 7" montato a bordo porta e moduli di uscita con cestelli a 19", le batterie sono alloggiare in armadio separato.

The ST24 Main-station (24 slots) is integrated into a metal cabinet that contains all system components. A second cabinet containing the battery pack is provided. Each Main-station has a variable number of Output and Input Modules, depending on system requirements, max. 24 slots. Each output module is divided into 1, 2 or 4 lines, each capable of controlling up to 32 luminaires for a maximum of 1380W for 1x version, 690W for 2x version, 345W for 4x version each line. The ST24 Main-station has a 7" graphic touch screen display mounted on the door and output modules with 19" housings, the batteries are housed in a separate cabinet.

 600x800x2000mm
Cent. e armadio batt.

Cod.	Descrizione Description	Autonomia Autonomy h	Moduli Modules OUT*	Moduli Modules IN**	N. armadi batteria N. of cabinets battery	Batteria Battery	Potenza W Power W		Peso Weight Kg
							Nominale*** Nominal***	Max EN50171	
LG230									
17650	CENTRALE ST24 S230 70Ah 1P	1	0	0	1	18 x (12 V 70 Ah)	10174	7631	788
17651	CENTRALE ST24 S230 70Ah 2P	2	0	0	1	18 x (12 V 70 Ah)	5594	4196	788
17652	CENTRALE ST24 S230 70Ah 3P	3	0	0	1	18 x (12 V 70 Ah)	4039	3029	788
17653	CENTRALE ST24 S230 90Ah 1P	1	0	0	1	18 x (12 V 90 Ah)	10822	8117	819
17654	CENTRALE ST24 S230 90Ah 2P	2	0	0	1	18 x (12 V 90 Ah)	6718	5039	819
17655	CENTRALE ST24 S230 90Ah 3P	3	0	0	1	18 x (12 V 90 Ah)	4860	3645	819
17656	CENTRALE ST24 S230 100Ah 1P	1	0	0	1	18 x (12 V 100 Ah)	14148	10611	921
17657	CENTRALE ST24 S230 100Ah 2P	2	0	0	1	18 x (12 V 100 Ah)	7841	5881	921
17658	CENTRALE ST24 S230 100Ah 3P	3	0	0	1	18 x (12 V 100 Ah)	5659	4244	921
17662	CENTRALE ST24 S230 120Ah 1P	1	0	0	1	18 x (12 V 120 Ah)	14774	11081	959
17663	CENTRALE ST24 S230 120Ah 2P	2	0	0	1	18 x (12 V 120 Ah)	9569	7177	959
17664	CENTRALE ST24 S230 120Ah 3P	3	0	0	1	18 x (12 V 120 Ah)	6653	4990	959
17668	CENTRALE ST24 S230 150Ah 1P	1	0	0	1	18 x (12 V 150 Ah)	18511	13883	1085
17669	CENTRALE ST24 S230 150Ah 2P	2	0	0	1	18 x (12 V 150 Ah)	11491	8618	1085
17670	CENTRALE ST24 S230 150Ah 3P	3	0	0	1	18 x (12 V 150 Ah)	8316	6237	1085
17671	CENTRALE ST24 S230 200Ah 1P	1	0	0	2	18 x (12 V 200 Ah)	24408	18306	1566
17672	CENTRALE ST24 S230 200Ah 2P	2	0	0	2	18 x (12 V 200 Ah)	15228	11421	1566
17673	CENTRALE ST24 S230 200Ah 3P	3	0	0	2	18 x (12 V 200 Ah)	11038	8279	1566
17674	CENTRALE ST24 S230 250Ah 1P	1	0	0	2	18 x (12 V 250 Ah)	30672	23004	1800
17675	CENTRALE ST24 S230 250Ah 2P	2	0	0	2	18 x (12 V 250 Ah)	19030	14273	1800
17676	CENTRALE ST24 S230 250Ah 3P	3	0	0	2	18 x (12 V 250 Ah)	13781	10336	1800

* Moduli espandibili fino a 24 slot - ** Moduli IN integrati espandibili fino a 8 / * Modules expandable up to 24 slots - ** Built-in IN modules expandable up to 8

CTS

SOTTOCENTRALI / SUB-UNITS



LG230

IP54



350x600x570mm

SOTTOCENTRALE ST8 LG230 / ST8 LG230 SUBSTATION

Display 7" integrato, Modulo OUT su 1, 2 o 4 linee, ciascuna controlla fino a 32 apparecchi: 1x 1380W max, 2x 690W max, 4x 345W max ogni linea.

Display, 7" integrated, OUT module on 1, 2 or 4 lines, each controls up to 32 luminaires: 1x 1380Wmax, 2x 690W max, 4x 345W max each line.

Cod.	Descrizione Description	Moduli / Modules OUT*	Moduli / Modules IN**	Peso / Weight Kg
17680	SOTTOCENTRALE ST8 S230	0	0	35

* Moduli espandibili fino a 8 slot - ** Moduli IN integrati espandibili fino a 2 / Moduli IN esterni espandibili fino a 96
* Modules expandable up to 8 slots - ** Built-in IN modules expandable up to 2 / External IN modules expandable up to 96



LG230

IP54



400x800x890mm

SOTTOCENTRALE ST16 LG230 / ST16 LG230 SUBSTATION

Display 7" integrato, Modulo OUT su 1, 2 o 4 linee, ciascuna controlla fino a 32 apparecchi: 1x 1380W max, 2x 690W max, 4x 345W max ogni linea.

Display, 7" integrated, OUT module on 1, 2 or 4 lines, each controls up to 32 luminaires: 1x 1380Wmax, 2x 690W max, 4x 345W max each line.

Cod.	Descrizione Description	Moduli / Modules OUT*	Moduli / Modules IN**	Peso / Weight Kg
17681	SOTTOCENTRALE ST16 S230	0	0	66

* Moduli espandibili fino a 16 slot - ** Moduli IN integrati espandibili fino a 4 / Moduli IN esterni espandibili fino a 96
* Modules expandable up to 16 slots - ** Built-in IN modules expandable up to 4 / External IN modules expandable up to 96



LG230

IP54



600x800x2000mm

SOTTOCENTRALE ST32 LG230 / ST32 LG230 SUBSTATION

Display 7" integrato, Modulo OUT su 1, 2 o 4 linee, ciascuna controlla fino a 32 apparecchi: 1x 1380W max, 2x 690W max, 4x 345W max ogni linea.

Display, 7" integrated, OUT module on 1, 2 or 4 lines, each controls up to 32 luminaires: 1x 1380Wmax, 2x 690W max, 4x 345W max each line.

Cod.	Descrizione Description	Moduli / Modules OUT*	Moduli / Modules IN**	Peso / Weight Kg
17682	SOTTOCENTRALE ST32 S230	0	0	163

* Moduli espandibili fino a 32 slot - ** Moduli IN integrati espandibili fino a 8 / Moduli IN esterni espandibili fino a 96
* Modules expandable up to 32 slots - ** Built-in IN modules expandable up to 8 / External IN modules expandable up to 96



LG230

IP20



400x316x144mm

SOTTOCENTRALE LG24 / LG24 SUBSTATION

Sottocentrale con display 7" touch, collegabile ad una Centrale LG230. Ogni modulo OUT è suddiviso su 1, 2 o 4 linee per controllare fino a 32 apparecchi a LG24

Substation control with 7" touch display, can be connected to an LG230 Main-station. Each OUT module is divided into 1, 2 or 4 lines to control up to 32 LG24 devices.

Cod.	Descrizione Description	Moduli / Modules OUT*	Moduli / Modules IN**	Peso / Weight Kg
17064	SOTTOCENTRALE S24	1 (4x32)	-	16

* Moduli IN esterni espandibili fino a 96 / * External IN modules expandable up to 96

COMPONENTI DI IMPIANTO / SYSTEM COMPONENTS



MODULO DRM LG230 / LG230 DRM MODULE

Il modulo DRM ricarica una batteria locale quando il sistema è in funzionamento ordinario. In caso di interruzione dei cavi di alimentazione, la batteria attraverso il modulo DRM fornisce alla lampada l'energia per intervenire in emergenza.
The DRM module charges a local battery when the system is in normal operation. In the event of the power cables interruption, the battery, through the DRM module, supplies the lamp with energy turns on the lamp in emergency.

Logica 230 230V 50Hz 216Vcc

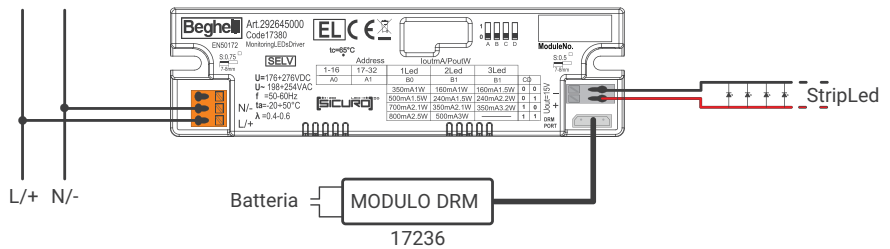

Cod.	Descrizione Description	Autonomia h Autonomy h	Tempo di ricarica h Recharging time h	Flusso lm*
17236	DRM LG230 + TEN YEARS BATTERY	1.5	7	110
RA09	BOOSTER BATTERY	3	14	-

* Flusso indicativo dipendente dal tipo di apparecchio / Flusso indicativo dipendente dal tipo di apparecchio

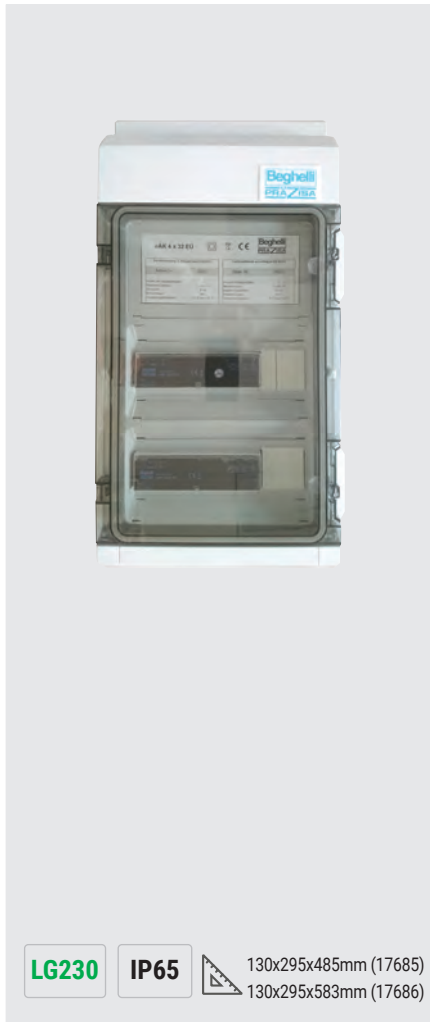

MODULO DI USCITA ESTERNO / EXTERNAL OUTPUT MODULE

Un quadro contiene tutti i componenti del sistema. Modulo OUT su 2 o 4 linee, max. 32 apparecchi per linea: max. 400W, tensione/ corrente per linea: 230 V / 1,75A.
A distributor panel contains all the system components. OUT module on 2 or 4 lines, max. 32 luminaires each line: max. 400W, voltage/current per circuit: 230 V/1.75A.

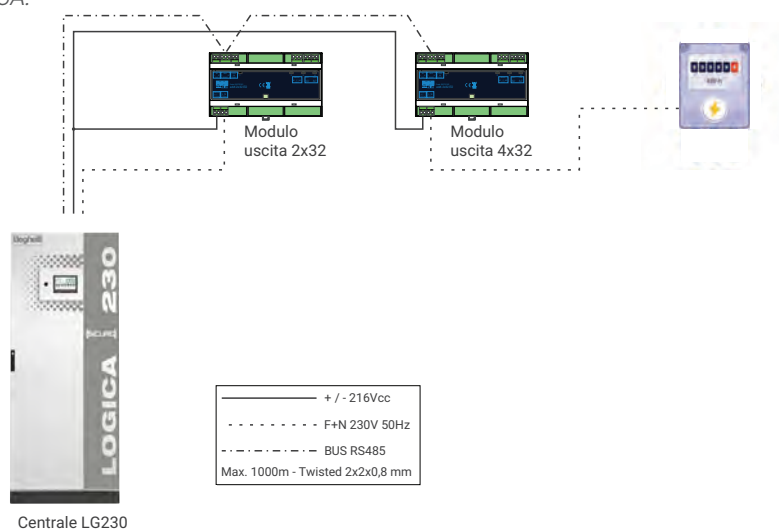

Cod.	W	Descrizione Description	Moduli / Modules OUT*	N. Apparecchi Collegabili	Peso Kg
17685	2x400	MOD DI USCITA EXT S230 2X32	1(2x32)	64	37
17686	4X400	MOD DI USCITA EXT S230 2+2X32	2 (2x32)	128	40

* Numero Moduli di uscita in dotazione 2x32 (max 400W per linea) / Number of output modules supplied 2x32 (300W max. for line)

177 sistemi a batteria centralizzata / centralised battery systems

COMPONENTI DI IMPIANTO / SYSTEM COMPONENTS



MODULO DI INGRESSO 230V / 230V INPUT MODULES

Monitor di rete per l'attivazione selettiva e programmabile dell'impianto. 8 ingressi - Uscita Relè - modulo DIN - Sensore trifase sugli ingressi 1,2,3 - $U < 85\%$ UNominal
Mains monitoring for selective and programmable activation of the system. 8 inputs - Relé output - Three-phase sensor on inputs 1,2,3 - $U < 85\%$ UNominal - DIN rail

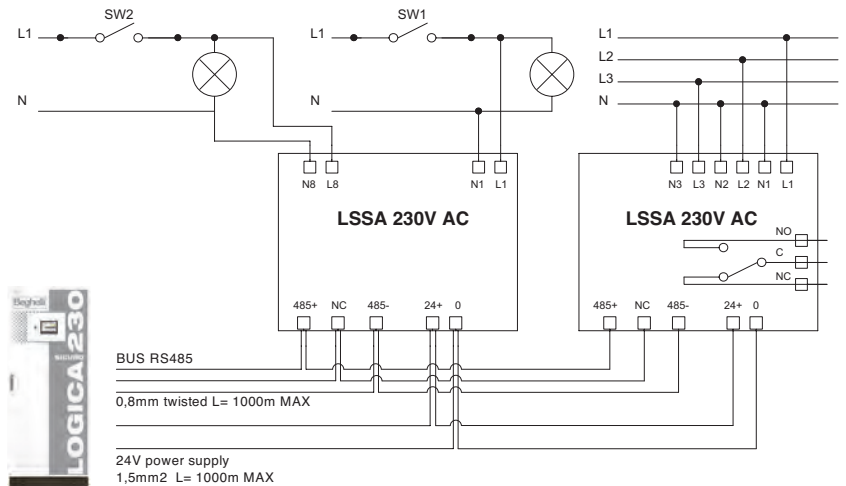

LG230

LG24



53x110x63mm

Cod.	Descrizione Description	Peso / Weight Kg
17230	MODULO INGRESSO LG 230V DIN	0.2



MODULO DI INGRESSO 24V / 24V INPUT MODULES

8 ingressi a contatti puliti (invertibili), comandabili da interruttori per illuminazione ordinaria. Controllo e assegnazione ad apparecchi di illuminazione o liberamente programmabili. / 8 control inputs with switch contacts (potential-free, invertible) to query the light switches for general lighting. Control inputs as well as assignment to luminaire circuits or luminaires free programmable.

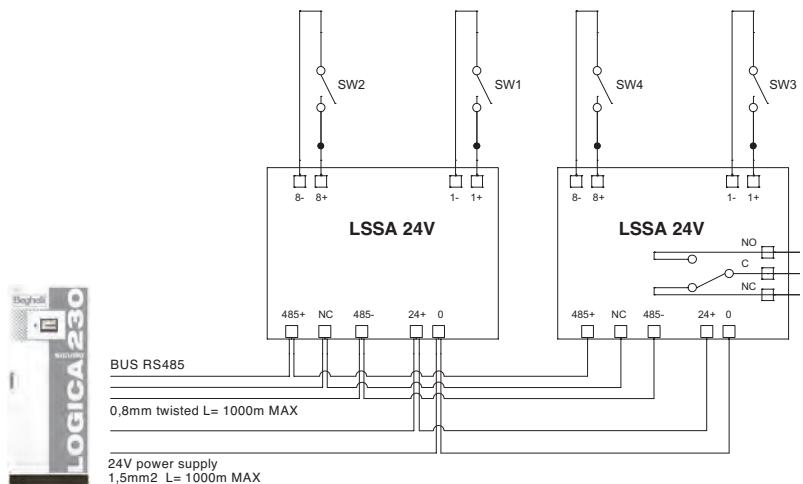

LG230

LG24



53x110x63mm

Cod.	Descrizione Description	Peso / Weight Kg
17231	MODULO INGRESSO LG 24V DIN	0.2

COMPONENTI DI IMPIANTO / SYSTEM COMPONENTS



INVERTER LED LG230 6-12W / LG230 6-12W LED INVERTER

Composto da Driver Led 12W e Commutatore a relè. - Tensione OUT Driver da 3 a 58Vdc con Potenza 6W o 12W (regolabile DA switch o da Centrale). / Composed of 12W LED Driver and relay Switch over Module. - OUT Driver voltage from 3 to 58Vdc with 6W or 12W power (adjustable via switch or control panel).

CALCOLO DEL FLUSSO LUMINOSO IN EMERGENZA (Flusso em)

Flusso em = 6W o 12W x Fn/Pn

Dove: Fn = Flusso nominale apparecchio

EMERGENCY LIGHT FLUX CALCULATION (em Flux)

Em flux = 6W or 12W x Fn/Pn

Where: Fn = Device nominal flux

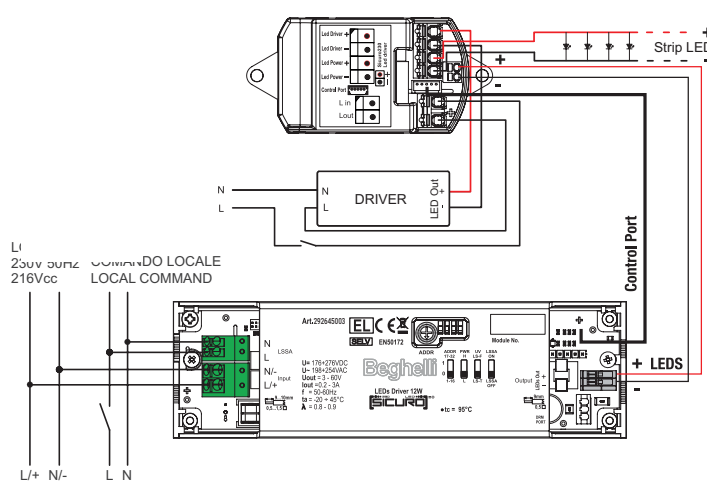

LG230 **IP20** 152x45x24mm Driver
22x51x31mm Relay

Cod.	Descrizione Description	Peso / Weight Kg
17381	INVERTER LG230 12W	0.3



MODULO LAMPADA 2,5-500W / 2,5-500W LAMP MODULE

Monitor e comando lampada, funzionamento sia SA che SE. Carico: 2,5W - 500W, Tensione di esercizio: 198 - 254Vca / 50Hz, Tensione da batteria: 176÷276Vcc
Monitor and lamp control, maintained (SA), non-maintained (SE) - Load: 2.5 W - 500 W, Operating voltage: 198 - 254Vca / 50Hz - Battery operating voltage: 176÷276VDC

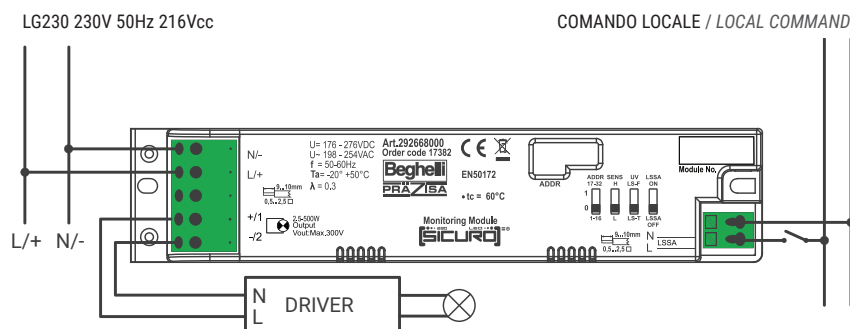

LG230 **IP20** 152x32x24mm

Cod. ord.	Descrizione Description	Peso / Weight Kg
17382	SWITCH 500W LG230	0.1

COMPONENTI DI IMPIANTO / SYSTEM COMPONENTS



MODULO LAMPADA DALI / DALI LAMP MODULE

Monitor e comando lampada DALI programmabile con Centrale, da LSSA locale o tramite Modulo ingresso, modalità SA o SE. Flusso luminoso in emergenza selezionabile da 1% a 100% - Carico da 4W a 400W.

Monitor and lamp control programmable by control unit, with local LSSA or via input Module, maintained non-maintained mode. Emergency luminous flux selectable from 1% to 100% - Load from 4W to 400W.

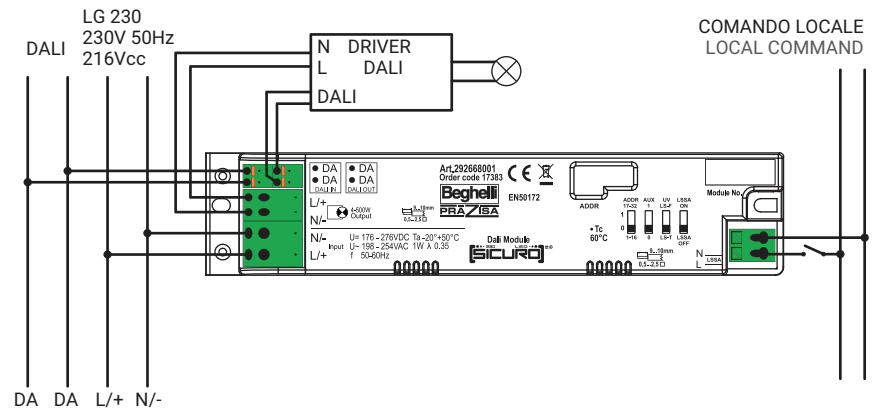

LG230 **IP20** 152x32x24mm

Cod.	Descrizione Description	Peso / Weight Kg
17383	SWITCH 500W LG230 DALI	0.1

ACCESSORI / ACCESSORY

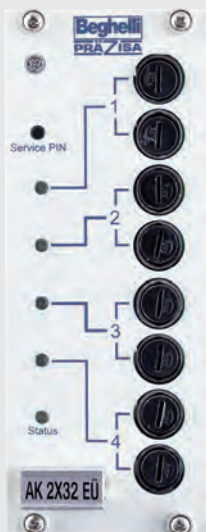

MODULO DI USCITA LG230 / LG230 OUTPUT MODULE

Gestione di 1, 2 o 4 linee, ciascuna controlla fino a 32 apparecchi: 1x 1380W max, 2x 690W max, 4x 345W max ogni linea. Modalità permanente (SA) e non permanente (SE) per ogni apparecchio sulla stessa linea. Monitoraggio individuale con rapporto di irregolarità selettivo sulla stessa linea, mediante comunicazione a onde convogliate con i moduli e apparecchi di emergenza - modalità permanente o modalità non permanente con attivazione selettiva della funzioni per linea / modulo. Montaggio su moduli 19" rack.

Management of 1, 2 or 4 lines, each controls up to 32 luminaires: 1x 1380W max, 2x 690W max, 4x 345W max each circuit. Maintained (SA) and non-maintained (SE) mode for each luminaire on the same line. Individual monitoring with selective irregularity report on the same line, by power line communication with the modules and emergency fittings - maintained and non-maintained mode with selective activation of functions per circuit / module. Mounting on 19" rack modules.

LG230 160x80x60mm

Cod.	Descrizione Description	Peso / Weight Kg
17232	MODULO DI USCITA LG230 2X32	0.2
17233	MODULO DI USCITA LG230 1X32	0.2
17234	MODULO DI USCITA LG230 4X32	0.2

ACCESSORI / ACCESSORY



SENSORE DI RETE / MAINS MONITORING MODULE

Modulo di monitoraggio dell'alimentazione di rete per illuminazione ordinaria, attivazione del controllo di uscita in caso di errori di mancanza rete: $U < 85\%$ $U_{Nominale}$. per barra DIN. Uscita di controllo: 2 scambi, contatti puliti, 230V / 3A
 Module for monitoring the mains supply of the general lighting in sub distributors. Activation of the control output during mains faults and mains failures with $U < 85\%$ $U_{Nominal}$. for DIN rail. Control output: 2 changeovers, potential-free, 230V / 3A

SENSORE MONOFASE / SINGLE PHASE SENSOR

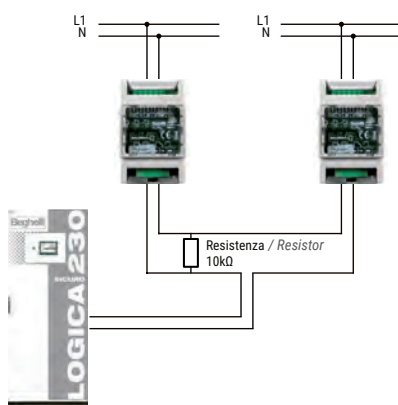

SENSORE TRIFASE / THREE-PHASE SENSOR

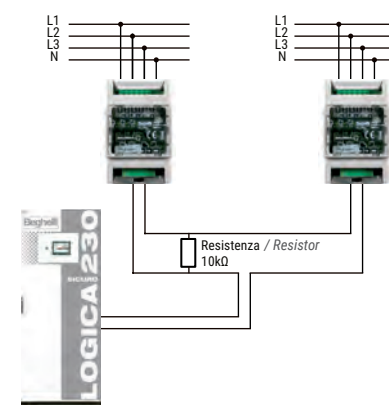

SENSORE TRIFASE / THREE-PHASE SENSOR

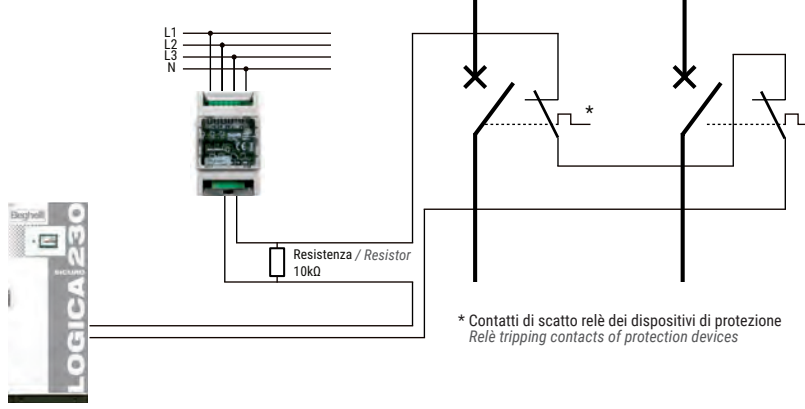

LG230

IP20

90x52x58mm

Cod.	Descrizione Description	Peso / Weight Kg
17385	DS3-UV 1-3 PHASE MONITORING	0.2



CONVERTITORE RS485-USB / RS485-USB CONVERTER

Interfaccia di collegamento da PC a centrali LG.
 Corpo: metallo - Classe di protezione: III - Installazione: su modulo DIN
 Connection interface from PC to LG control units
 Body: metal - Protection class: III - Installation: on DIN rail

LG230

IP20

151x75x26mm

Cod.	Descrizione Description	Peso / Weight Kg
12136	CONVERTITORE RS485 USB	0.5

ACCESSORI / ACCESSORY



CONTROLLER BATTERIE / BATTERY CONTROLLER

Monitor di tensione, temperatura e stabilizzazione/bilanciamento di tutti i pacchi batteria LG230. Connessione via bus (bus DALI) fra batterie e Centrale LG230.

Monitor voltage, temperature and stabilization/balancing of all LG230 battery packs. Connection via bus (DALI bus) between batteries and LG230 control unit.

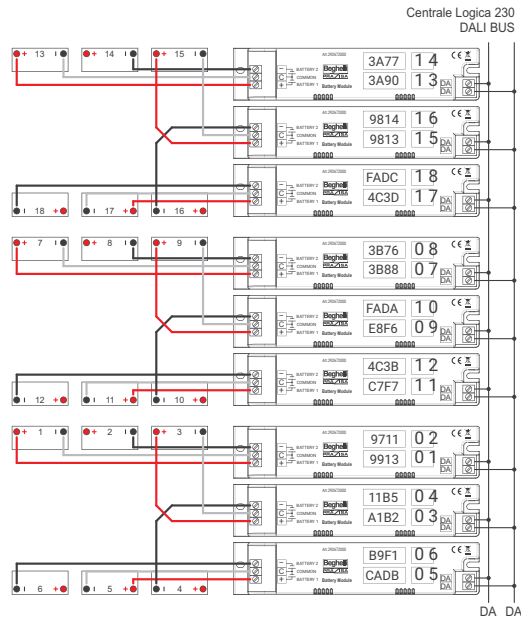

LG230

IP20

152x32x24mm

Cod.	Descrizione Description	Peso / Weight Kg
17384	KIT BATTERY MONITORING LG230	1



MODULO LS-UV / LS-UV MODULE

Accessorio integrabile negli apparecchi LG230 per verificare o attivare l'accensione da rete (LS) o verificare la presenza di rete a bordo lampada (UV).

Accessory integrabled into LG230 luminaires to verify or activate mains switch-on (LS) or verify the presence of mains on the lamp (UV).

LS= 230V - ON; 0V - OFF
UV= 0V - ON; 230V - OFF

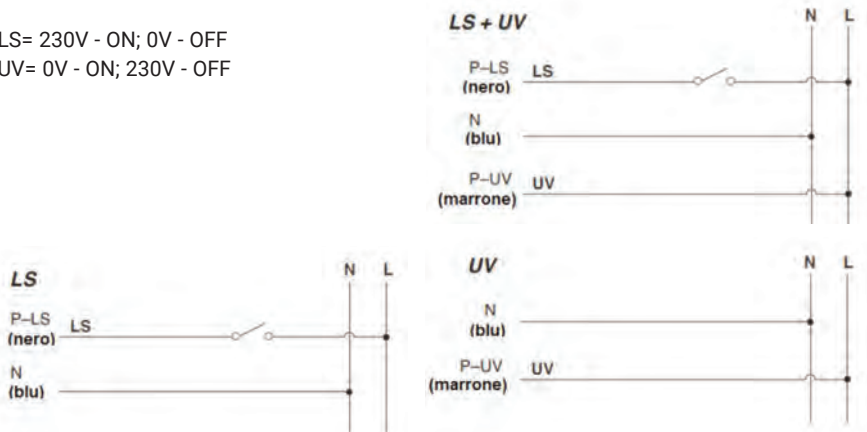

LG230

IP20

80x12x19mm

Cod.	Descrizione Description	Peso / Weight Kg
17237	MODULO LS-UV LG230	1

ACCESSORI / ACCESSORY



LG230

IP20

275x96x225mm

PANNELLO REMOTO TOUCH / REMOTE TOUCH SCREEN PANEL

Pannello remoto con touch color screen 7" per controllo/monitoraggio fino a 63 centrali. Classe di isolamento I

Esecuzione test, comandi e segnalazioni.

Contatti di segnalazione programmabili.

3 uscite tramite relè (programmabili) per segnalazioni.

Interfaccia RS485 e Ethernet.

Remote panel with 7" color touch screen for control/monitoring of up to 63 control units. Insulation class I

Execution of tests, commands and reports.

Programmable signaling contacts.

3 outputs via relay (programmable) for signaling.

RS485 and Ethernet interface.

Cod.	Descrizione Description	Peso / Weight Kg
17240	REMOTE PANEL 7" W LG24 LG230	3.5

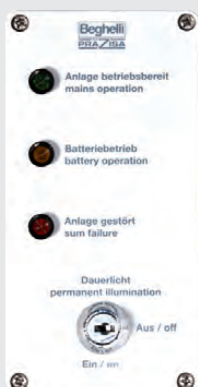

LG230

IP65

160x80x60mm

PANNELLO REMOTO A PARETE / WALL-MOUNTED REMOTE PANEL

Controllo della modalità di funzionamento sia per impianti LG230 che LG24. Corpo in plastica per montaggio a parete. Indicatore di inibizione della modalità Emergenza, stato di funzionamento, presenza di errori.

Controllo della modalità di funzionamento da SE a SA (con comando ON OFF) .

Operation mode control for both LG230 and LG24 systems.

Plastic body for wall mounting. Emergency inhibition indicator, operating status, presence of errors. Operating mode control from SE (non-maintained) to SA. (maintained) in ON/OFF mode.

Cod.	Descrizione Description	Peso / Weight Kg
17207	PANNELLO PARETE LG24 LG230	0.5



LG230

IP20

86x86x53mm

PANNELLO REMOTO A INCASSO / RECESSED REMOTE PANEL

Controllo della modalità di funzionamento sia per impianti LG230 che LG24. Indicatore di inibizione della modalità emergenza, stato di funzionamento, presenza di errori. Controllo modalità da SE a SA (con comando ON OFF).

Operation mode control for both LG230 and LG24 systems.

Emergency inhibition indicator, operating status, presence of errors. Operating mode control from SE (non-maintained) to SA. (maintained) in ON/OFF mode.

Cod.	Descrizione Description	Peso / Weight Kg
17208	PANNELLO INCASSO LG24 LG230	0.2

ESEMPIO DI CONFIGURAZIONE IMPIANTISTICA / EXAMPLE OF SYSTEM



MODULO DI USCITA LG230
LG230 OUTPUT MODULE



1 2

Selettività di intervento in emergenza
 e da eventuale guasto
*Selectivity of intervention in an emergency
 situation and for a possible failure*

CONFIGURATION

Tutte le configurazioni riportate nello schema, sono programmabili semplicemente da Centrale, senza alcuna modifica impiantistica, utilizzando la sola linea di alimentazione delle lampade e riconfigurabili a seconda delle mutate esigenze dell'impianto.

All the configurations shown in the diagram can be programmed simply from the control unit, without any changes to the system, using only the lamp power supply line, and can be reconfigured according to changing system requirements.

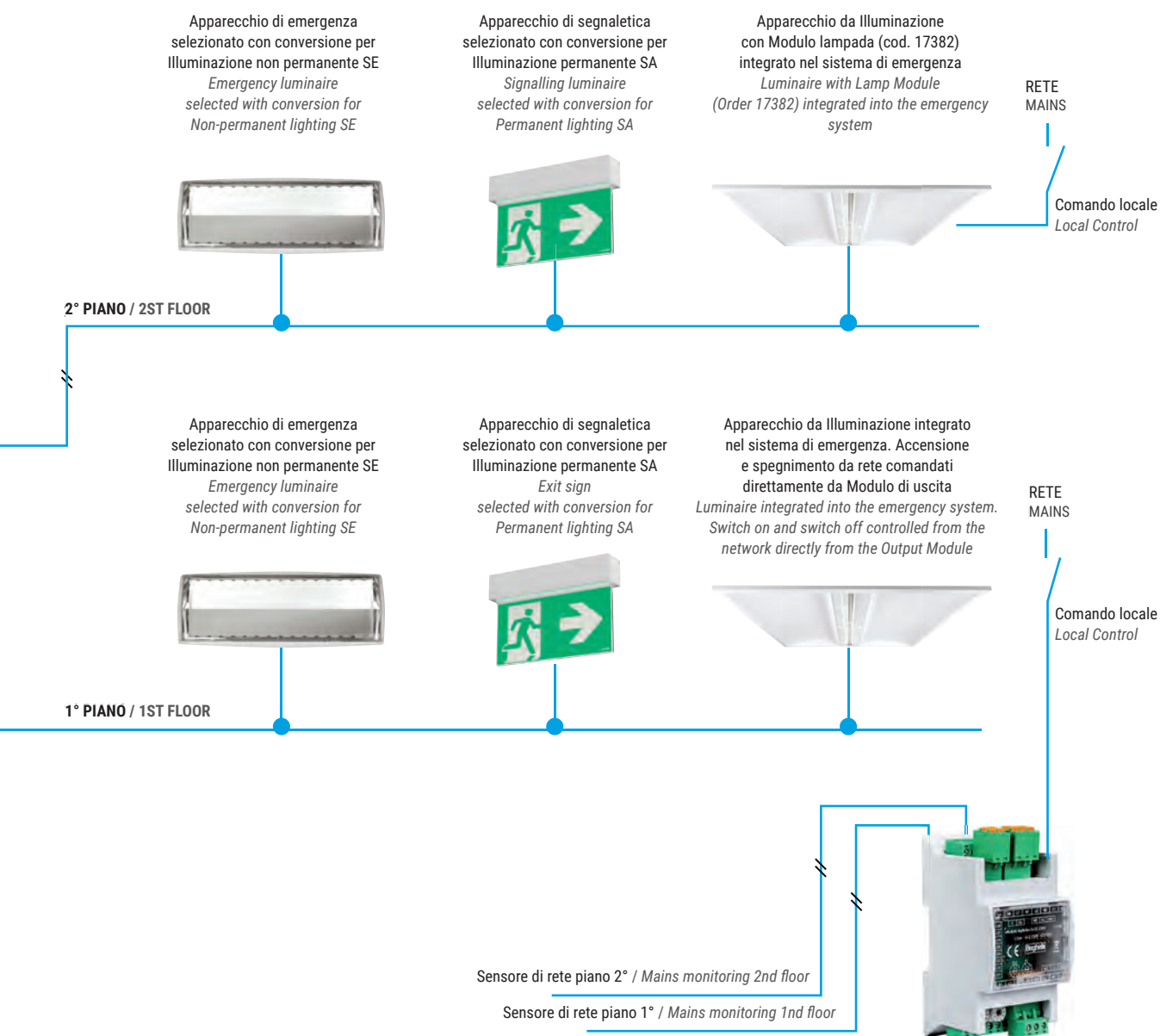



Sistema di alimentazione centralizzata per illuminazione di emergenza con funzioni di diagnosi e test automatici di funzionamento e di autonomia utilizzando una **bassissima tensione che permette riduzione dei costi e notevole aumento della sicurezza.**

Secondo le normative DIN EN 50172 il sistema si configura nella protezione di classe III. Durante il funzionamento in emergenza viene erogata una tensione continua a 24Vdc. Inverter LED per commutare gli apparecchi di illuminazione ordinaria nell'impianto di illuminazione di emergenza. BMS compatibile tramite appositi software.

*Centralized power supply for emergency lighting with diagnosis functions and automatic operation and autonomy tests. using a **extra-low voltage which allows cost reduction and increase in safety.** According to DIN EN 50172, the system is protection rating is class III. During emergency operation, a continuous 24VDC voltage is supplied. By inserting the specific LED inverter, ordinary luminaires can be integrated into the emergency lighting system BMS compatible by specific software.*

Conformità / Compliance

2014/35/EU, EN50171, EN62485-2, EN62034, EN62040-1, EN50172, UNI11222

CENTRALI DI CONTROLLO / CONTROL UNITS

La Centrale di controllo LG24 è disponibile in 2 configurazioni standard che variano in base al numero di linee (4 linee, 8 linee). Ogni Centrale dispone di autonomia da 1 a 3h a cui corrispondono potenze decrescenti.

The LG24 Control Unit is available in 2 standard configurations that vary according to the number of lines (4 lines, 8 lines). Each control unit is with an adjustable autonomy from 1 h to 3 hrs, with decreasing powers.

CENTRALI LG24 / LG24 CONTROL UNITS

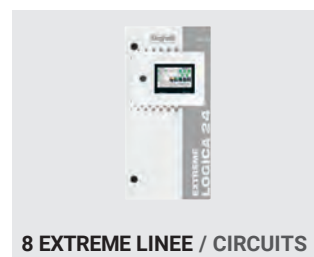
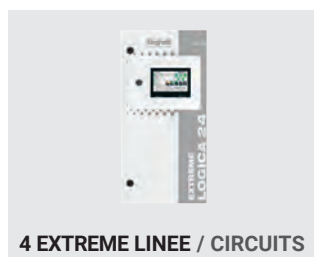
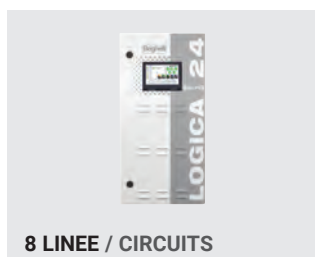

FUNZIONI

- Controllo e monitoraggio di apparecchi per emergenza:
 - linea comune, differente modo di funzionamento
 - Conversione degli apparecchi selezionati, in modalità permanente o non permanente (SE / SA)
 - Per gli apparecchi SA funzione dimmer 10-100%;
- Attivazione selettiva della modalità SE mediante moduli di ingresso esterni in caso di parziale mancanza di rete
- Riconoscimento automatico delle linee e dei moduli di controllo lampada installati
- Monitoraggio individuale di 32 lampade per linea
- Esecuzione automatica dei test funzionali e di autonomia
- Report automatico dei test eseguiti.
- Memorizzazione degli eventi per due anni (LOG-BOOK)

FUNCTIONS

- Control and monitoring of emergency equipment:
 - common cable, different working mode
 - Conversion of selected devices, in permanent or non-permanent mode (SE / SA)
 - For SA (permanent) luminaires, 10-100% dimmer function;
- Selective activation of SE mode via external input modules in case of partial power failure
- Automatic lines recognition and installed lamp control modules
- Individual monitoring of 32 lamps per line
- Automatic execution of functional and autonomy tests
- Automatic report of tests performed.
- Event logging for two years (LOG-BOOK)

FRAZIONAMENTO DELL'IMPIANTO

Il sistema LG24 è particolarmente indicato in situazioni dove il frazionamento dell'impianto di emergenza risulta vantaggioso. Ogni centrale viene collegata ad un PC per la supervisione che, a sua volta, può essere collegato in cloud con il portale web NuBe Beghelli.

SYSTEM SPLITTING

The LG24 system is particularly suitable for situations where splitting up the emergency system is advantageous. Each control unit is connected to a PC for supervision which, in turn, can be connected in the cloud with the NuBe Beghelli web portal.



ESEMPLIFICAZIONE DI IMPIANTO LG24 FRAZIONATO CON PIÙ CENTRALI / EXAMPLE OF A SPLIT LG24 SYSTEM WITH SEVERAL POWER STATIONS

SISTEMI CENTRALIZZATI A BASSA TENSIONE

LOGICA 230/24 permette la composizione di un impianto misto composto da moduli a 230V e moduli a 24V utilizzando LOGICA 230 e LOGICA 24 anche in modalità dinamica. Inoltre è possibile collegare in emergenza apparecchi già utilizzati per l'illuminazione ordinaria, con il semplice inserimento dello specifico Modulo lampada. È sempre possibile integrare LOGICA 230/24 in un sistema BMS (Building Management System). Ogni apparecchio è in grado di eseguire la diagnostica richiesta dalla Norma UNI 11222 dialogando individualmente con la centrale utilizzando le linee di alimentazione per lo scambio delle informazioni per mezzo di tecnologia ad onde convogliate: la Centrale invia sulle linee di alimentazione dedicate agli apparecchi, una trasmissione digitale codificata in modo da essere "ascoltata" solo dall'apparecchio a cui è indirizzata. Con questa tecnologia si limitano le connessioni e i cavi di installazione con evidente risparmio di materiale e manodopera.

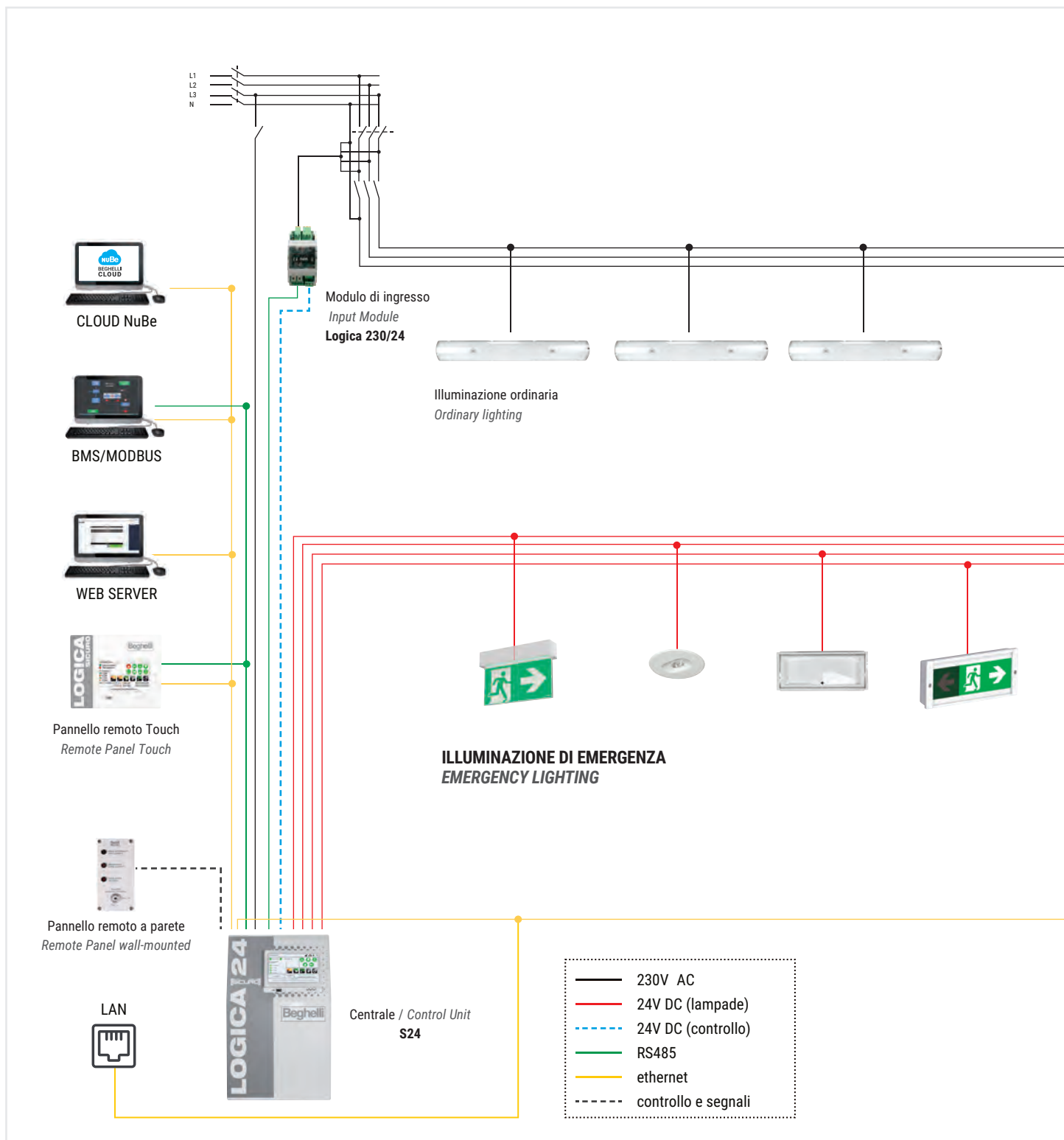

DECENTRALISED LOW-VOLTAGE SYSTEMS

LOGICA 230/24 allows composing a mixed system consisting of 230V modules and 24V modules using LOGICA 230 and LOGICA 24 also in dynamic mode. In addition, it is possible to connect luminaires already used for ordinary lighting as emergency luminaires, by simply inserting the specific Lamp Module, and it is always possible to integrate LOGICA 230/24 into a BMS system (Building Management System). Each luminaire can carry out the diagnostics required by the UNI 11222 standard, by communicating individually with the control unit using the power supply lines for information exchange by means of the power-line communication technology: the Control Unit sends an encoded digital transmission on the power supply lines dedicated to the luminaires, which transmission is only received by the luminaire to which it is addressed. This technology limits the number of connections and installation cables with obvious savings in material and labour.

MASSIMA LUNGHEZZA DEL CAVO PER LA CADUTA MAX DI TENSIONE DI 3,5V

MAXIMUM CABLE LENGTH FOR A MAXIMUM VOLTAGE DROP OF 3,5V

Carico / Load (A)	Sezione / Cross-section (mm ²)	Lunghezza / Length (m)
3	1,5	49
2	1,5	74
1	1,5	147
3	2,5	82
2	2,5	123
1	2,5	245

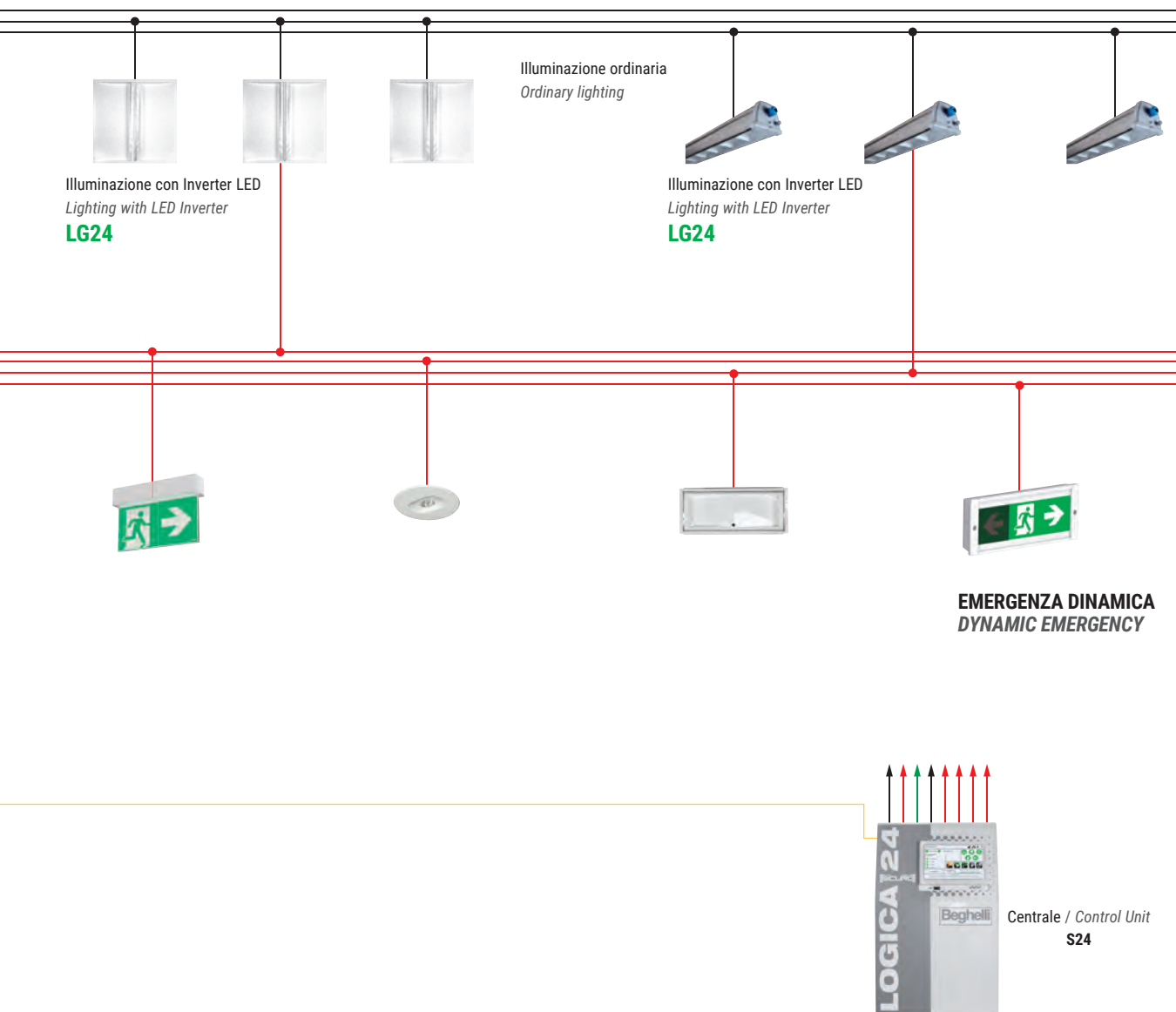

CENTRALE LG24 - 4 LINEE / LG24 CONTROL UNIT - 4 CIRCUITS



Centrale di controllo LOGICA 24 con 4 circuiti di uscita integrati all'interno di un armadio in metallo che contiene tutti i componenti del sistema e i gruppi batterie. Ogni circuito di uscita è in grado di controllare fino a 32 apparecchi.

Il monitoraggio degli apparecchi esegue un test funzionale del sistema ed un test di durata che serve a valutare l'autonomia in caso di emergenza. I risultati dei test vengono memorizzati all'interno della centrale e possono essere condivisi. Tutte le centrali LG24 integrano un display touch a colori 7" ", le batterie sono alloggiare direttamente nella parte inferiore dell'armadio della Centrale.

LOGICA 24 Control Unit with 4 output circuits integrated into a metal cabinet that contains all system components and battery packs. Each output circuit can control up to 32 luminaires. Luminaire monitoring performs a functional test of the system and an endurance test to assess autonomy in case of emergency. Test results are stored in the control unit and can be shared. All LG24 control units feature a 7" colour touch screen display, the batteries are housed directly in the lower part of the control unit cabinet.

	Cod.	Descrizione Description	Potenza / Autonomia Power / Autonomy			Batteria Battery		Circuiti di uscita Output circuits	Corrente massima Maximum current	Colore Colour RAL	Peso Weight Kg
			1h	2h	3h	Capacità totale Total capacity	Numero e Tipo Number and Type				
LG24	17060	LG24 4U 12Ah B	156W	88.8W	67.2W	12Ah	2x 12V 12Ah	4	3A	9003	15
	17061	LG24 4U 24Ah B	288W	180.8W	134.4W	24Ah	4x 12V 12Ah	4	3A	9003	25.7

Moduli IN esterni espandibili fino a 96 / External IN modules expandable up to 96

CENTRALE LG24 - 4 E 8 LINEE / LG24 CONTROL UNIT - 4 AND 8 CIRCUITS



Centrale di controllo LOGICA 24 con 4 e 8 circuiti di uscita integrati all'interno di un armadio in metallo che contiene tutti i componenti del sistema e i gruppi batterie. Ogni circuito di uscita è in grado di controllare fino a 32 apparecchi.

Il monitoraggio degli apparecchi esegue un test funzionale del sistema ed un test di durata che serve a valutare l'autonomia in caso di emergenza. I risultati dei test vengono memorizzati all'interno della centrale e possono essere condivisi. Tutte le centrali LG24 integrano un display touch a colori 7", le batterie sono alloggiare direttamente nella parte inferiore dell'armadio della Centrale.

LOGICA 24 Control Unit with 4 and 8 output circuits integrated into a metal cabinet that contains all system components and battery packs. Each output circuit can control up to 32 luminaires.

Luminaire monitoring performs a functional test of the system and an endurance test to assess autonomy in case of emergency. Test results are stored in the control unit and can be shared. All LG24 control units feature a 7" colour touch screen display, the batteries are housed directly in the lower part of the control unit cabinet.

	Cod.	Descrizione Description	Potenza / Autonomia Power / Autonomy			Batteria Battery		Circuiti di uscita Output circuits	Corrente massima Maximum current	Colore Colour RAL	Peso Weight Kg
			1h	2h	3h	Capacità totale Total capacity	Numero e Tipo Number and Type				
LG24	17065	LG24 8U 28Ah G	384W	233W	170W	28Ah	2x 12V 28Ah	8	3A	7035	39.5
	17066	LG24 8U 56Ah G	384W	384W	334W	56Ah	4x 12V 28Ah	8	3A	7035	58.5
	17062	LG24 4U 28Ah G	288W	232.8W	170W	28Ah	2x 12V 28Ah	4	3A	7035	37.5
	17063	LG24 4U 56Ah G	288W	288W	288W	56Ah	4x 12V 28Ah	4	3A	7035	56.5

Moduli IN esterni espandibili fino a 96 / External IN modules expandable up to 96

CENTRALE LG24 EXTREME-4 LINEE / LG24 EXTREME CONTROL UNIT-4 LINES



Centrale di controllo LOGICA 24 con 4 circuiti di uscita integrati all'interno di un armadio in metallo che contiene tutti i componenti del sistema e i gruppi batterie. Ogni circuito di uscita è in grado di controllare fino a 32 apparecchi.

Il monitoraggio degli apparecchi esegue un test funzionale del sistema ed un test di durata che serve a valutare l'autonomia in caso di emergenza. I risultati dei test vengono memorizzati all'interno della centrale e possono essere condivisi. Tutte le centrali LG24 integrano un display touch a colori 7" , le batterie sono alloggiare direttamente nella parte inferiore dell'armadio della Centrale. Le batterie LTO (Litio Titanio) garantiscono prestazioni e affidabilità elevatissime e possibilità di impiego a temperature estreme: -20°C +50°C.

LOGICA 24 Control Unit with 4 output circuits integrated into a metal cabinet that contains all system components and battery packs. Each output circuit can control up to 32 luminaires.

Luminaire monitoring performs a functional test of the system and an endurance test to assess autonomy in case of emergency. Test results are stored in the control unit and can be shared. All LG24 control units feature a 7" colour touch screen display, the batteries are housed directly in the lower part of the control unit cabinet. LTO (Lithium Titanium) batteries guarantee high performance and reliability and can be used in extreme temperatures: -20°C +50°C.

	Cod.	Descrizione Description	Potenza / Autonomia Power / Autonomy			Batteria Battery		Circuiti di uscita Output circuits	Corrente massima Maximum current	Colore Colour RAL	Peso Weight Kg
			1h	2h	3h	Capacità totale Total capacity	Numero e Tipo Number and Type				
LG24	17075	LG24 4U EXTREME 20Ah	288W	192W	108W	20Ah	1x 12V 20Ah	4	3A	7035	33
	17076	LG24 4U EXTREME 40Ah	288W	288W	216W	40Ah	2x 12V 20Ah	4	3A	7035	39

Moduli IN esterni espandibili fino a 96 / External IN modules expandable up to 96

CENTRALE LG24 EXTREME-8 LINEE / LG24 EXTREME CONTROL UNIT-8 LINES



Centrale di controllo LOGICA 24 con 8 circuiti di uscita integrati all'interno di un armadio in metallo che contiene tutti i componenti del sistema e i gruppi batterie. Ogni circuito di uscita è in grado di controllare fino a 32 apparecchi.

Il monitoraggio degli apparecchi esegue un test funzionale del sistema ed un test di durata che serve a valutare l'autonomia in caso di emergenza. I risultati dei test vengono memorizzati all'interno della centrale e possono essere condivisi. Tutte le centrali LG24 integrano un display touch a colori 7", le batterie sono alloggiare direttamente nella parte inferiore dell'armadio della Centrale. Le batterie LTO (Lito Titanio) garantiscono prestazioni e affidabilità elevatissime e possibilità di impiego a temperature estreme: -20°C +50°C.

LOGICA 24 Control Unit with 8 output circuits integrated into a metal cabinet that contains all system components and battery packs. Each output circuit can control up to 32 luminaires.

Luminaire monitoring performs a functional test of the system and an endurance test to assess autonomy in case of emergency. Test results are stored in the control unit and can be shared. All LG24 control units feature a 7" colour touch screen display, the batteries are housed directly in the lower part of the control unit cabinet. LTO (Lithium Titanium) batteries guarantee high performance and reliability and can be used in extreme temperatures: -20°C +50°C.

	Cod.	Descrizione Description	Potenza / Autonomia Power / Autonomy			Batteria Battery		Circuiti di uscita Output circuits	Corrente massima Maximum current	Colore Colour RAL	Peso Weight Kg
			1h	2h	3h	Capacità totale Total capacity	Numero e Tipo Number and Type				
LG24	17077	LG24 8U EXTREME 20Ah	384W	192W	108W	20Ah	1x 12V 20Ah	8	3A	7035	35
	17078	LG24 8U EXTREME 40Ah	384W	384W	216W	40Ah	2x 12V 20Ah	8	3A	7035	41

Moduli IN esterni espandibili fino a 96 / External IN modules expandable up to 96

COMPONENTI DI IMPIANTO / SYSTEM COMPONENTS



MODULO DI INGRESSO 230V / 230V INPUT MODULES

Monitor di rete per l'attivazione selettiva e programmabile dell'impianto. 8 ingressi
 - Uscita Relè - modulo DIN - Sensore trifase sugli ingressi 1,2,3 - $U < 85\%$ UNominal
Mains monitoring for selective and programmable activation of the system. 8 inputs
 - Relé output - Three-phase sensor on inputs 1,2,3 - $U < 85\%$ UNominal - DIN rail

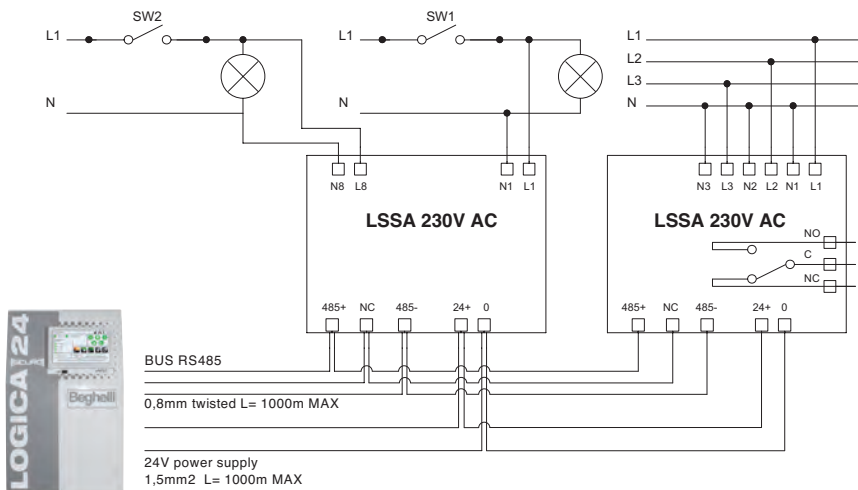

Cod.	Descrizione Description	Peso / Weight Kg
17230	MODULO INGRESSO LG 230V DIN	0.2

LG230

LG24



53x110x63mm



MODULO DI INGRESSO 24V / 24V INPUT MODULES

8 ingressi a contatti puliti (invertibili), comandabili da interruttori per illuminazione ordinaria. Controllo e assegnazione ad apparecchi di illuminazione o liberamente programmabili. / 8 control inputs with switch contacts (potential-free, invertible) to query the light switches for general lighting. Control inputs as well as assignment to luminaire circuits or luminaires free programmable.

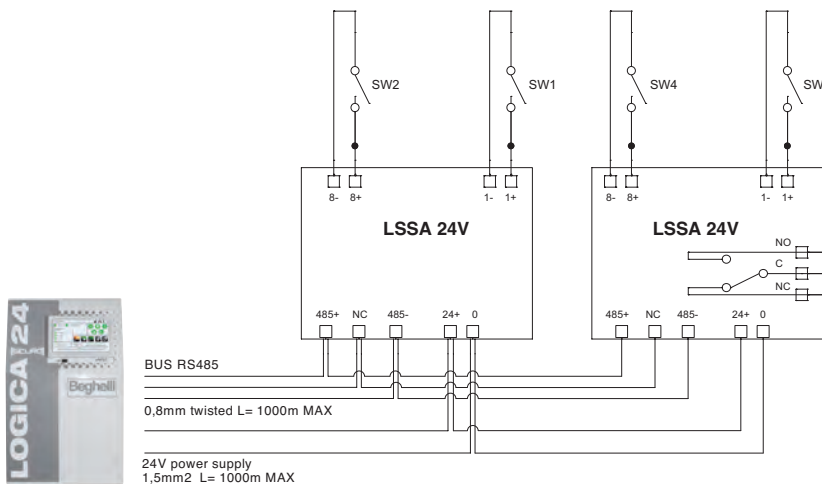

Cod.	Descrizione Description	Peso / Weight Kg
17231	MODULO INGRESSO LG 24V DIN	0.2

LG230

LG24



53x110x63mm

COMPONENTI DI IMPIANTO / SYSTEM COMPONENTS



INVERTER LED LG24 6-12W / LG24 6-12W LED INVERTER

Modulo di monitoraggio e controllo con driver LED integrato per emergenza e indirizzamento automatico di apparecchi di illuminazione a LED con tensione di uscita dal driver da 2 V a 55 V dc. Potenza driver 6W o 12W (programmabile da centrale S24).

Module with plastic housing for installation inside LED luminaires with the Driver output voltage from 2 to 55V. It allows the management of LED emergency luminaires.

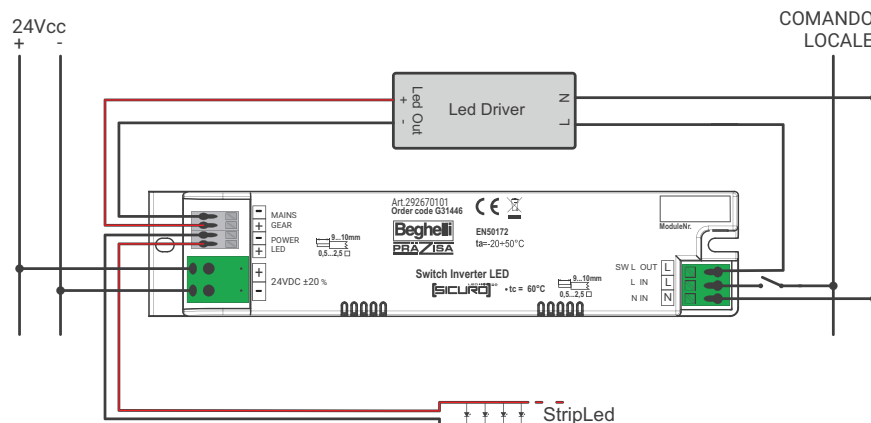

LG24



239x46x30mm (17220)
301x139x55mm (17210)

Cod.	Descrizione Description	Grado di protezione Protection rating	Peso / Weight Kg
17210	INV LED IP65 LOGICA 24V	IP65	0.8
17220	INV LED LG LOGICA 24V	IP40	0.1

ACCESSORI / ACCESSORY



PANNELLO REMOTO TOUCH / REMOTE TOUCH SCREEN PANEL

Pannello remoto con touch color screen 7" per controllo/monitoraggio fino a 63 centrali. Classe di isolamento I

Esecuzione test, comandi e segnalazioni.

Contatti di segnalazione programmabili.

3 uscite tramite relè (programmabili) per segnalazioni.

Interfaccia RS485 e Ethernet.

Remote panel with 7" color touch screen for control/monitoring of up to 63 control units. Insulation class I

Execution of tests, commands and reports.

Programmable signaling contacts.

3 outputs via relay (programmable) for signaling.

RS485 and Ethernet interface.

LG24

IP20



275x96x225mm

Cod.	Descrizione Description	Peso / Weight Kg
17240	REMOTE PANEL 7" W LG24 LG230	3.5

SEGUE / NEXT >

ACCESSORI / ACCESSORY



LG24

IP20

86x86x53mm

PANNELLO REMOTO A INCASSO / RECESSED REMOTE PANEL

Controllo della modalità di funzionamento sia per impianti LG230 che LG24. Indicatore di Inibizione della modalità emergenza, stato di funzionamento, presenza di errori. Controllo modalità da SE a SA (con comando ON OFF).

Operation mode control for both LG230 and LG24 systems.

Emergency inhibition indicator, operating status, presence of errors. Operating mode control from SE (non-maintained) to SA. (maintained) in ON/OFF mode.

Cod.	Descrizione Description	Peso / Weight Kg
17208	PANNELLO INCASSO LG24 LG230	0.2

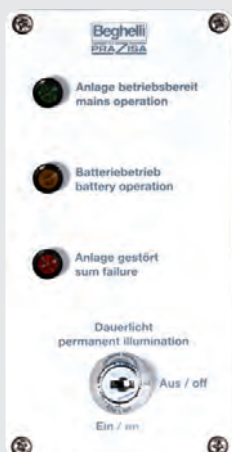

LG24

IP65

160x80x60mm

PANNELLO REMOTO A PARETE / WALL-MOUNTED REMOTE PANEL

Controllo della modalità di funzionamento sia per impianti LG230 che LG24. Corpo in plastica per montaggio a parete. Indicatore di Inibizione della modalità Emergenza, stato di funzionamento, presenza di errori.

Controllo della modalità di funzionamento da SE a SA (con comando ON OFF) .

Operation mode control for both LG230 and LG24 systems.

Plastic body for wall mounting. Emergency inhibition indicator, operating status, presence of errors. Operating mode control from SE (non-maintained) to SA. (maintained) in ON/OFF mode.

Cod.	Descrizione Description	Peso / Weight Kg
17207	PANNELLO PARETE LG24 LG230	0.5

ACCESSORI / ACCESSORY



SENSORE DI RETE / MAINS MONITORING MODULE

Modulo di monitoraggio dell'alimentazione di rete per illuminazione ordinaria, attivazione del controllo di uscita in caso di errori di mancanza rete: $U < 85\% U_{Nominale}$. per barra DIN. Uscita di controllo: 2 scambi, contatti puliti, 230V / 3A
 Module for monitoring the mains supply of the general lighting in sub distributors. Activation of the control output during mains faults and mains failures with $U < 85\% U_{Nominal}$. for DIN rail. Control output: 2 changeovers, potential-free, 230V / 3A

SENSORE MONOFASE SINGLE PHASE SENSOR

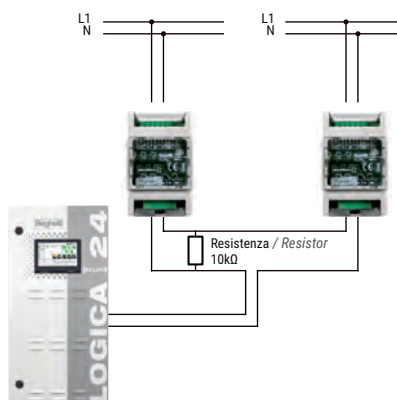

SENSORE TRIFASE THREE-PHASE SENSOR

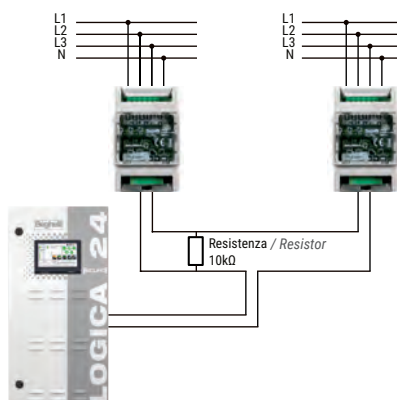

SENSORE TRIFASE THREE-PHASE SENSOR

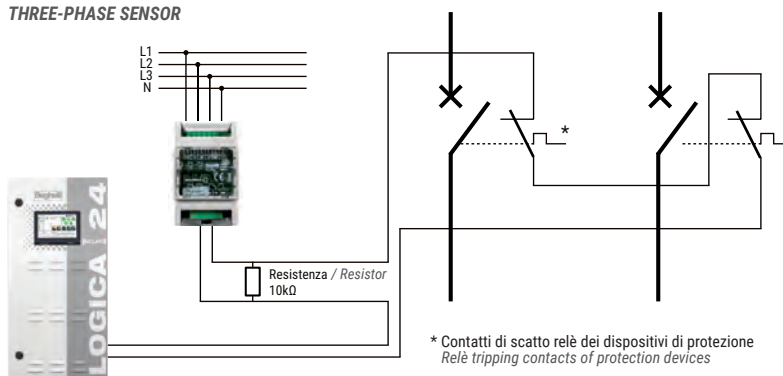

Cod.	Descrizione Description	Peso / Weight Kg
17385	DS3-UV 1-3 PHASE MONITORING	0.2

LG24

IP20

90x52x58mm



La segnaletica di salvataggio e di sicurezza è concepita per illuminare il luogo sicuro verso l'esterno del fabbricato o verso i Punti di raccolta, indicando il percorso più breve anche in caso di interruzioni di corrente. Un sistema di emergenza dinamico tiene conto di queste situazioni, bloccando visivamente le vie di fuga inutilizzabili e mostrando alternative sicure. Logica 24 Dynamic può essere integrato in qualsiasi impianto con centrali LG24 o LG24 Extreme, interfacciando il sistema, ad esempio, con l'impianto di antincendio.

Rescue and safety signs are designed to illuminate the safe place outside the building or towards the assembly points, indicating the shortest route even in the event of power failures. Only a dynamic emergency system can take into account these situations, visually blocking unusable escape routes and showing safe alternatives. The LG24 dynamic system can be integrated into any system with LG24 or LG24 Extreme control units, interfacing the system, for example, with the fire fighting system.

NORMATIVE DI SICUREZZA IN EVOLUZIONE / EVOLVING SAFETY REGULATIONS

I Sistemi dinamici di segnalazione di sicurezza si inseriscono in un quadro normativo che, a partire dalle segnalazioni di sicurezza nei luoghi di lavoro, vengono regolata in termini generali dal DLGS 81/08 e in termini particolari attraverso principi più moderni enunciati dal DM 03 Agosto 2015 (Approvazione di norme tecniche di prevenzione incendi).

Dynamic safety signalling systems are part of an regulatory framework which, starting from the cornerstones of safety signalling at the workplace, regulated in general terms by Legislative Decree 81/08 through the most modern principles set out in Ministerial Decree of 03 August 2015 (Approval of technical standards for fire prevention).

CENTRALI LG24 / LG24 CONTROL UNITS



4-8 LINEE / CIRCUITS



4 LINEE / CIRCUITS - 8 EXTREME

APPARECCHI / LUMINAIRES



SEGUI LED



SEGUI LED STEP



KUBUS DYNAMIC

SEGNALETICA DINAMICA, PER SCEGLIERE LE VIE DI FUGA IN SICUREZZA

Il Sistema LOGICA 24 permette di incrementare la sicurezza dei luoghi di lavoro in presenza di più vie d'esodo, gestendo le situazioni di conflitto, l'indisponibilità delle vie di esodo per situazioni di emergenza. Il sistema è inoltre idoneo nei luoghi affollati dove è stato sperimentalmente dimostrato come in caso di emergenza, le persone siano orientate ad uscire dal luogo ripercorrendo a ritroso la via utilizzata per arrivarvi. Il Sistema dinamica invece è in grado di evitare comportamenti istintivi, attirando maggiormente l'attenzione e fornendo con la sua dinamicità un'informazione specifica alla sola direzione di fuga più sicura.

DYNAMIC EMERGENCY SIGNS, TO CHOOSE ESCAPE ROUTES SAFELY

The LOGICA 24 system makes it possible to increase the safety of workplaces, in particular complex places with more than one escape route, by managing conflict situations, the unavailability of escape routes for emergency situations. The system is also particularly suitable in crowded places where bystanders are unfamiliar with the location. In these situations, it has been demonstrated that, in a situation of emergency, people are directed to leave the place by going back on the route they used to get there. On the other hand, the dynamic system is able to avoid instinctive behaviour, attracting more attention and providing with its dynamism specific information on the safest escape direction.

UN SISTEMA DINAMICO SI BASA SU DUE PRINCIPI FONDAMENTALI:

- 1 Impedire alle persone di intraprendere vie di esodo pericolose già sature di fumi
- 2 Consentire alle persone in aree già sature di fumo di intraprendere vie di esodo più sicure.

A DYNAMIC SYSTEM IS BASED ON TWO FUNDAMENTAL PRINCIPLES:

- 1 Prevent people from taking dangerous smoke-saturated escape routes
- 2 Enable people in areas already saturated with smoke to take safer escape routes.

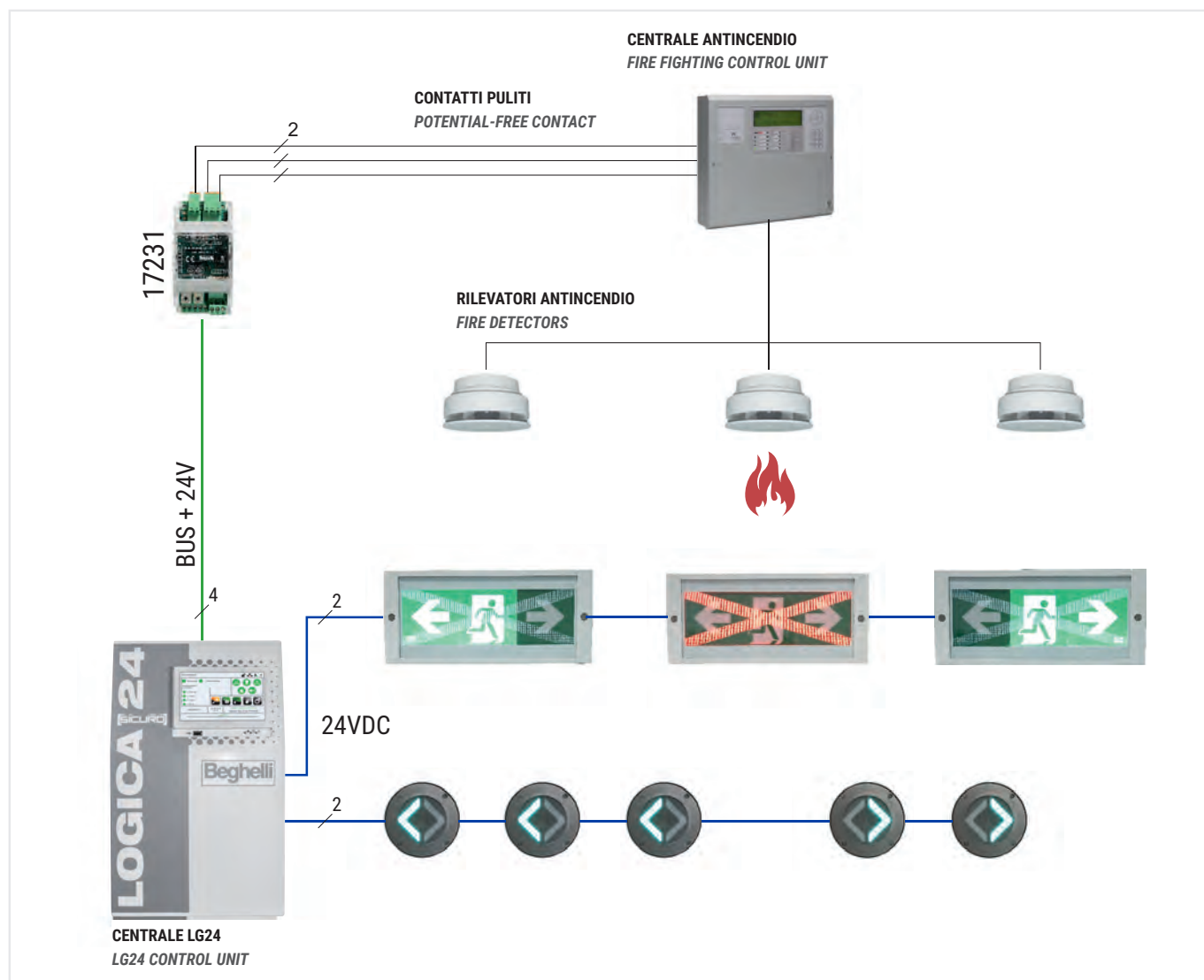

emergenza / emergency

IMPIANTO CON SISTEMA LG24 DYNAMIC IN MODALITÀ STATICA
SYSTEM WITH LG24 DYNAMIC SYSTEM IN STATIC MODE

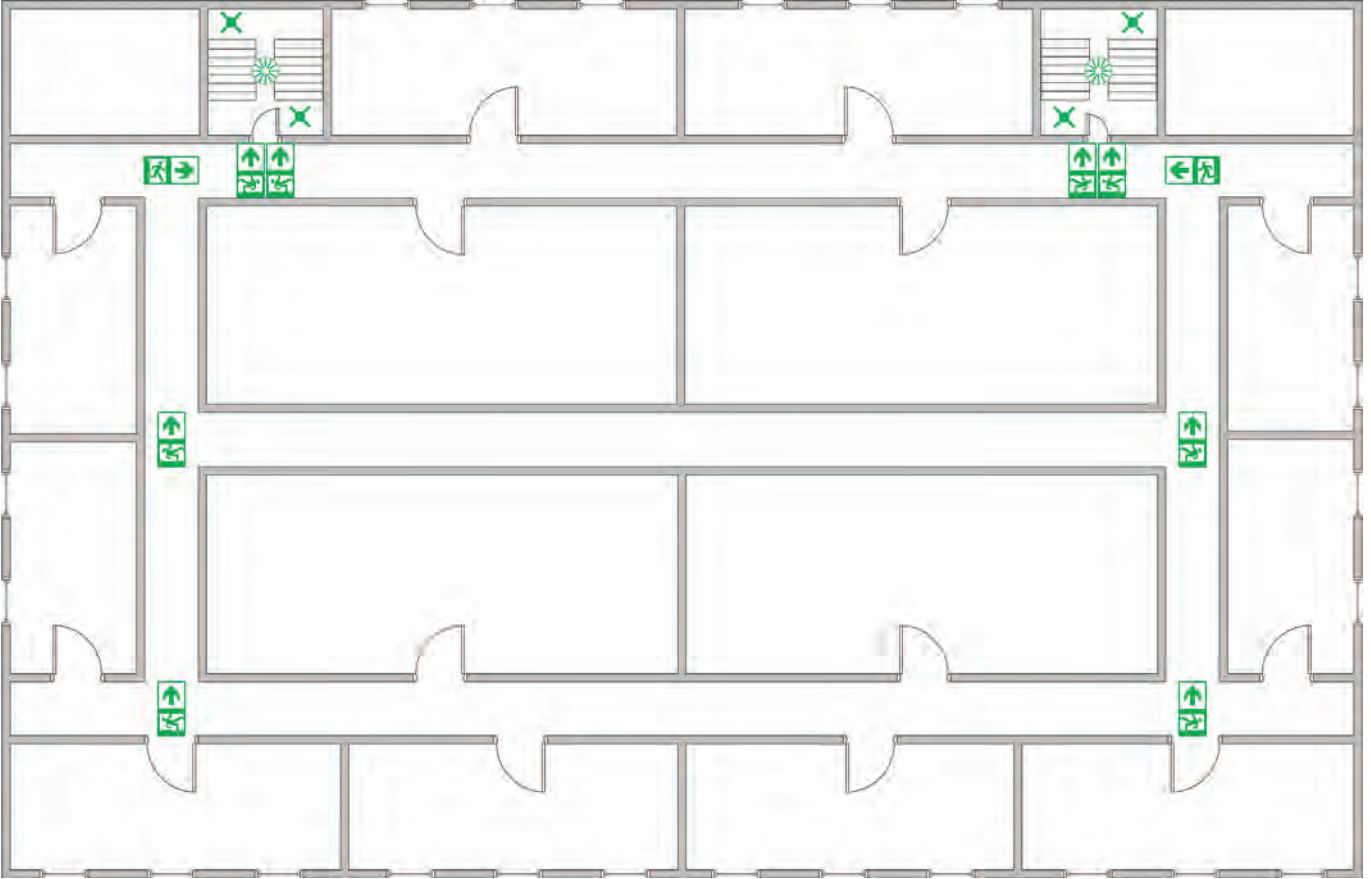

IMPIANTO CON SISTEMA LG24 DYNAMIC IN MODALITÀ DINAMICA
SYSTEM WITH LG24 DYNAMIC SYSTEM IN DYNAMIC MODE

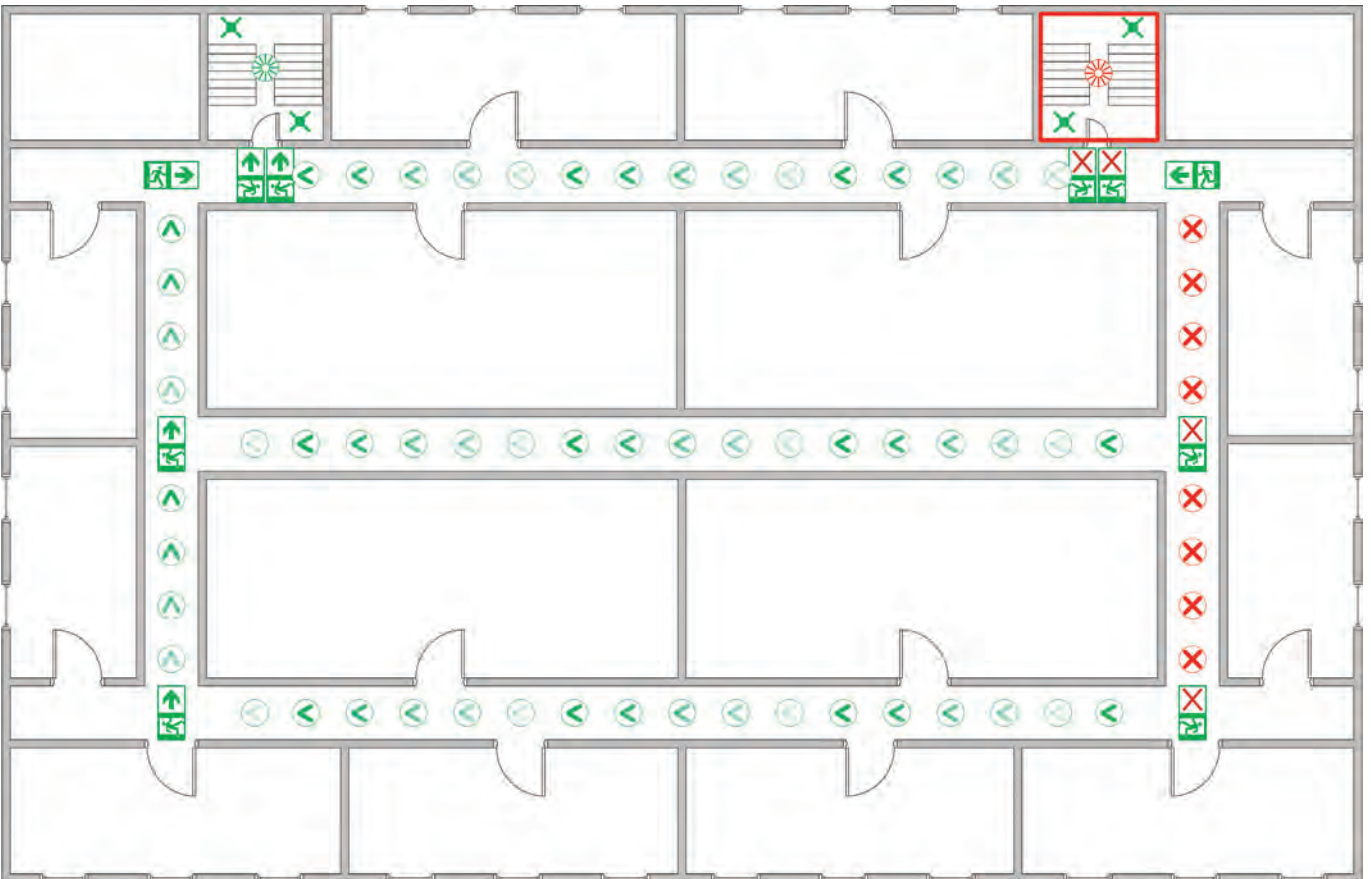

SEGUI LED / FIRE EXIT SIGN



LG24 IP54 III

Segnaletica dinamica idonea in zone ad alto rischio, tramite il collegamento fra la Centrale LG24 e i sensori dell'impianto antincendio, segnala la via di fuga a minor indice di rischio.

Dynamic sign for high-risk areas, through the connection between the Control unit and the fire detectors, show the escape route safer.

392x175x62mm



SITUAZIONE DI PERICOLO A DESTRA
DANGER SITUATION ON THE RIGHT



SITUAZIONE DI PERICOLO A SINISTRA
DANGEROUS SITUATION ON THE LEFT

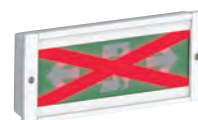

SITUAZIONE GRAVE DI PERICOLO
SERIOUS DANGER SITUATION

	Cod.	Descrizione Description	Assorbimento DC / DC power input W	Peso / Weight Kg
CTS	LG230			
	34000	SEGUI LED LG24 DYNAMIC	2.8	2.5

SEGUI LED STEP / FIRE EXIT STEP SIGN



LG24 IP66 III

Segnaletica dinamica in acciaio Inox per incasso a terra idoneo in zone ad alto rischio. Grazie al collegamento fra Centrale e Sensori antincendio, consente di stabilire la via di fuga a minor indice di rischio.

Inox Dynamic sign recessed floor for high-risk areas, through the connection between the Control unit and the fire detectors, show the escape route safer.

Ø131 x 77mm



	Cod.	Descrizione Description	Assorbimento DC / DC power input W	Peso / Weight Kg
CTS	LG230			
	34002	SEGUI LED STEP LG24 DYNAMIC	1.6	1.1

KUBUS DYNAMIC



LG24 IP40 III

Segnaletica dinamica idonea in zone ad alto rischio, tramite il collegamento fra la Centrale LG24 e i sensori dell'impianto antincendio, segnala la via di fuga a minor indice di rischio.

Dynamic sign for high-risk areas, through the connection between the Control unit and the fire detectors, show the escape route safer.

368x158x119mm
368x169x104mm

	Cod.	Descrizione Description	Assorbimento DC / DC power input W	Peso / Weight Kg
CTS	LG230			
	34006	KUBUS DYNAMIC LG24 PARETE	2.8	2.2
	34007	KUBUS DYNAMIC LG24 BANDIERA	2.8	1.8



LG EPS è un sistema di emergenza per apparecchi ad alimentazione centralizzata in impianti di medie o grandi dimensioni. Il progetto si focalizza sull'integrazione fra apparecchi di emergenza autoalimentata di tipo CT, con illuminazione ordinaria, e illuminazione di emergenza centralizzata CTS, HT, continuando a garantire l'esecuzione delle verifiche automatiche in conformità alla CEI EN 62034. La scelta del soccorritore va fatta in base al numero di apparecchi collegati, alle funzioni richieste e agli apparecchi di illuminazione ordinaria da alimentare, tramite Modulo LG EPS, per il funzionamento in modalità emergenza.

LG EPS is an emergency system for centrally powered appliances in medium or large-sized systems. The project focuses on the integration between CT type self-contained emergency luminaires, with ordinary lighting, and CTS, HT centralized emergency lighting, in order to guarantee the execution of automatic checks in compliance with CEI EN 62034. The choice of the LG EPS system, operating in emergency mode, it's given to the number of connected devices, the functions required and the ordinary lighting devices to be powered by the LG EPS Module.

- LG EPS
- 1984
DISPOSITIVI
- IP20
- +35°C
-5°C
- BATTERY
+20°C
EN50171

SOCCORRITORE EPS ECO STATIC INVERTER EPS ECO

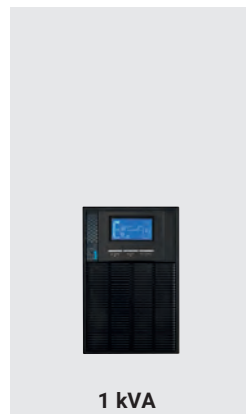
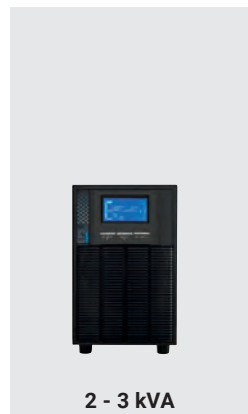

SOCCORRITORE EPS PRO STATIC INVERTER EPS PRO



GESTIONE SEMPLIFICATA E RIDUZIONE DEI TEMPI DI MANUTENZIONE

Una nuova linea di apparecchi di emergenza LG EPS è stata resa disponibile per soddisfare qualsiasi esigenza impiantistica, sia di emergenza che di segnaletica di sicurezza. Tutti i nuovi apparecchi possono essere collegati insieme agli apparecchi di illuminazione ordinaria cablati in emergenza, allo stesso bus di comunicazione LG EPS e vengono gestiti dal medesimo controllore. In caso di blackout, un sensore di fase, conforme al tempo di intervento e ai livelli di tensione, interrompe il BUS, in modo da assicurare il funzionamento istantaneo in emergenza di tutti gli apparecchi. I vantaggi sui costi di installazione e di cablaggio sono elevati, considerando che gli stessi apparecchi di illuminazione ordinaria funzionano anche in emergenza con un utilizzo dei cavi di comunicazione più ridotto e razionale. Anche la gestione dell'impianto è semplificata e razionalizzata con ulteriore risparmio di costi e di tempo, inoltre sia la gestione che il monitoraggio dell'impianto possono avvenire da remoto grazie al Cloud NuBe Beghelli con cui è possibile attivare anche la funzione di manutenzione predittiva per anticipare eventuali guasti e pianificare al meglio la manutenzione.

EASY MANAGEMENT AND REDUCTION OF MAINTENANCE TIMES

A new line of LG EPS emergency luminaires has been made available to satisfy any installation requirement, both emergency and safety sign. All the new luminaires can be connected together with the ordinary lighting luminaires wired in emergency, to the same LG EPS communication bus and are managed by the same controller. In the case of blackout, a phase sensor, compliant with the intervention time and voltage levels, interrupts the BUS, in order to the operation of all luminaires in emergency mode. High advantages on installation and wiring low costs, given that the same ordinary luminaires also work in emergencies with a more reduced and rational use of communication cables. The management of the system is also simplified and rationalized with further savings in costs and time, furthermore both the management and monitoring of the system can take place remotely thanks to the Beghelli NuBe Cloud with which it is also possible to activate the predictive maintenance function for anticipate any breakdowns and plan maintenance as best as possible.

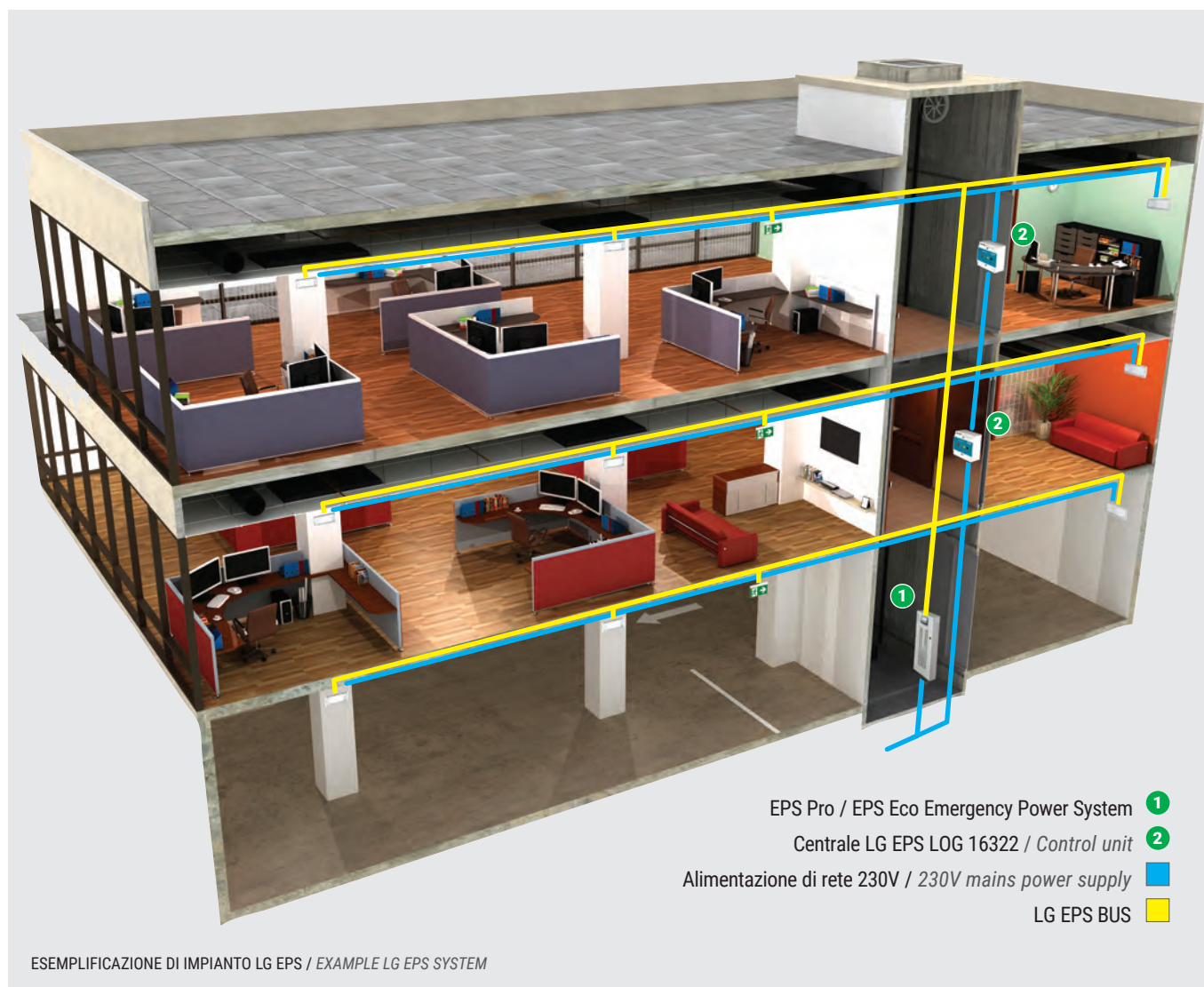

ESEMPLIFICAZIONE DI IMPIANTO LG EPS / EXAMPLE LG EPS SYSTEM



BEGHELLI CLOUD

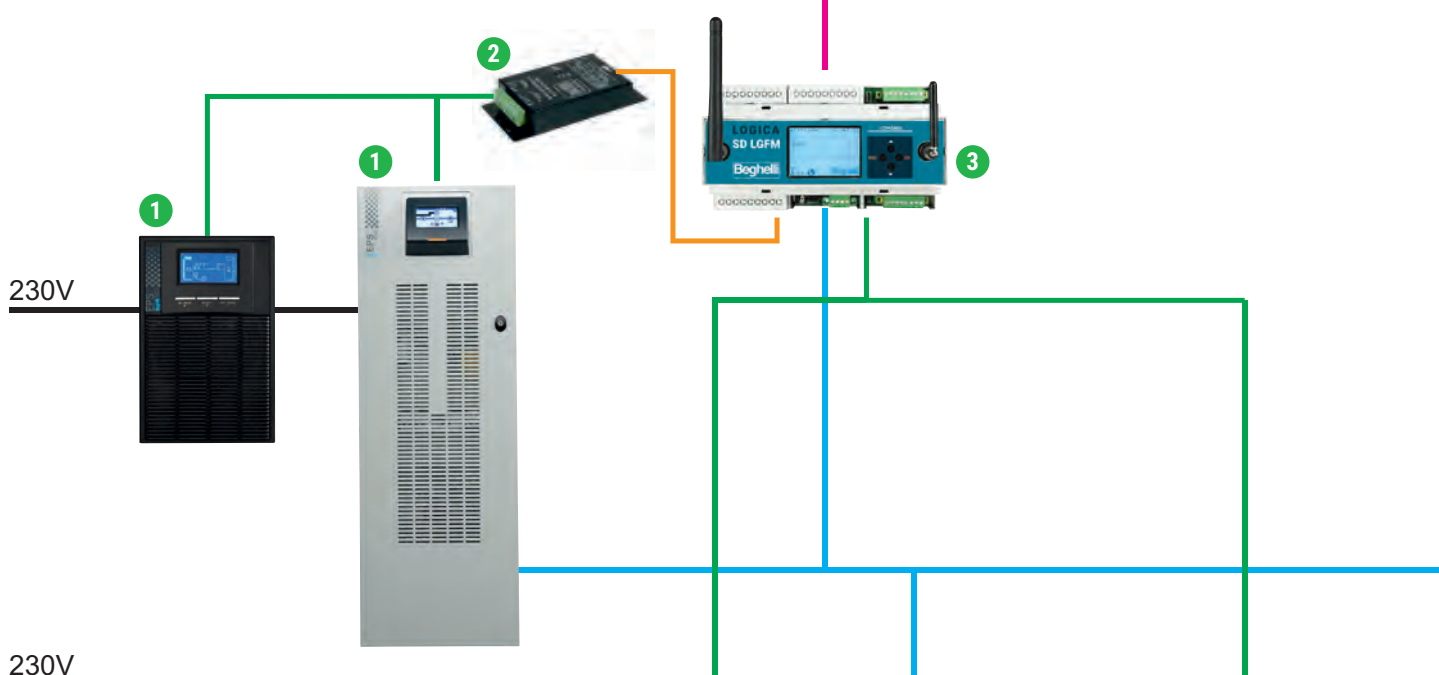

230V

- 1 EPS PRO - EPS ECO Emergency Power System
- 2 Convertitore / Converter RS232 - RS485 - Cod. 12134
- 3 Centrale di supervisione / supervision Control Unit LG - Cod. 12131C
- 4 Centrale / Control Unit LG EPS LOG - Cod. 16322
- 5 Circuito di protezione illuminazione ordinaria
Ordinary lighting protection circuit
- 6 Circuito di protezione illuminazione di emergenza
Emergency lighting protection circuit
- 7 Apparecchi / Luminaires LG EPS
- 8 Segnaletica / Exit Sign LG EPS
- 9 Apparecchi illuminazione ordinaria con modulo SWITCH
Ordinary lighting fixtures with SWITCH module
LG EPS 500W - Cod.17386
- 10 Illuminazione ordinaria / General lighting
- 11 Centrale / Control Unit CONNECT LG - Cod. 12100C
- 12 Apparecchi / Luminaires LG
- 13 Segnaletica / Exit Sign LG
- 14 Apparecchi illuminazione ordinaria con INVERTER LG
Ordinary lighting fixtures with LG INVERTER

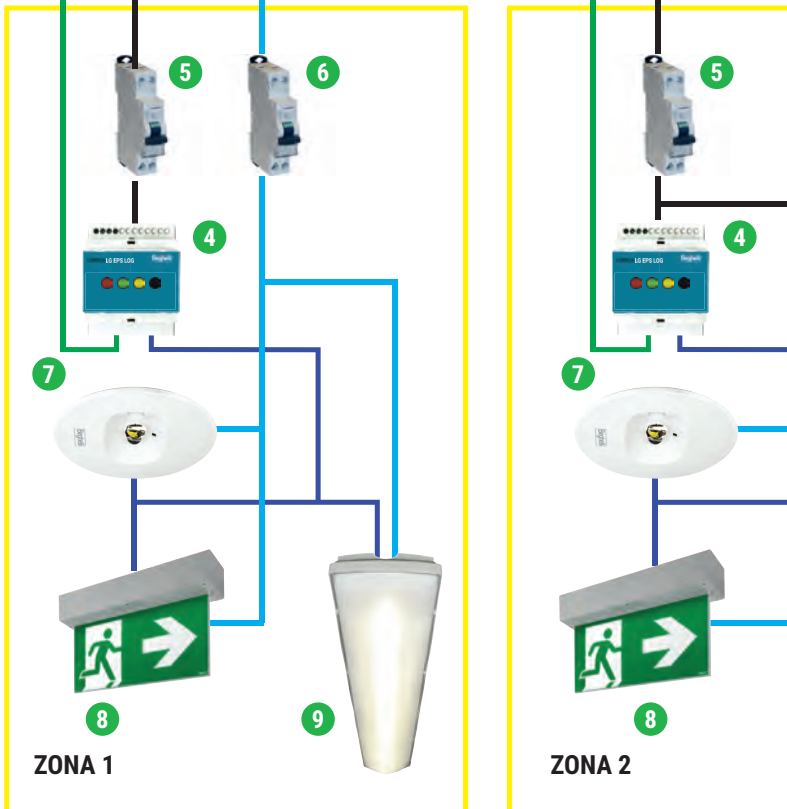

FRAZIONAMENTO DELL'IMPIANTO E SEMPLIFICAZIONE DELLE PROCEDURE DI CONTROLLO

Per il frazionamento dell'impianto viene utilizzata la nuova Centrale LG EPS LOG che, in combinazione con la Centrale LG Connect e la Centrale di supervisione, permette il controllo delle singole aree anche tramite il Cloud NuBe Beghelli.

DIVIDE THE SYSTEM AND SIMPLIFYING THE CONTROL PROCEDURES

To divide the system, the new LG EPS LOG control unit is used which, in combination with the LG Connect control unit and the supervision control unit, allows the control of individual areas also via the NuBe Beghelli Cloud.

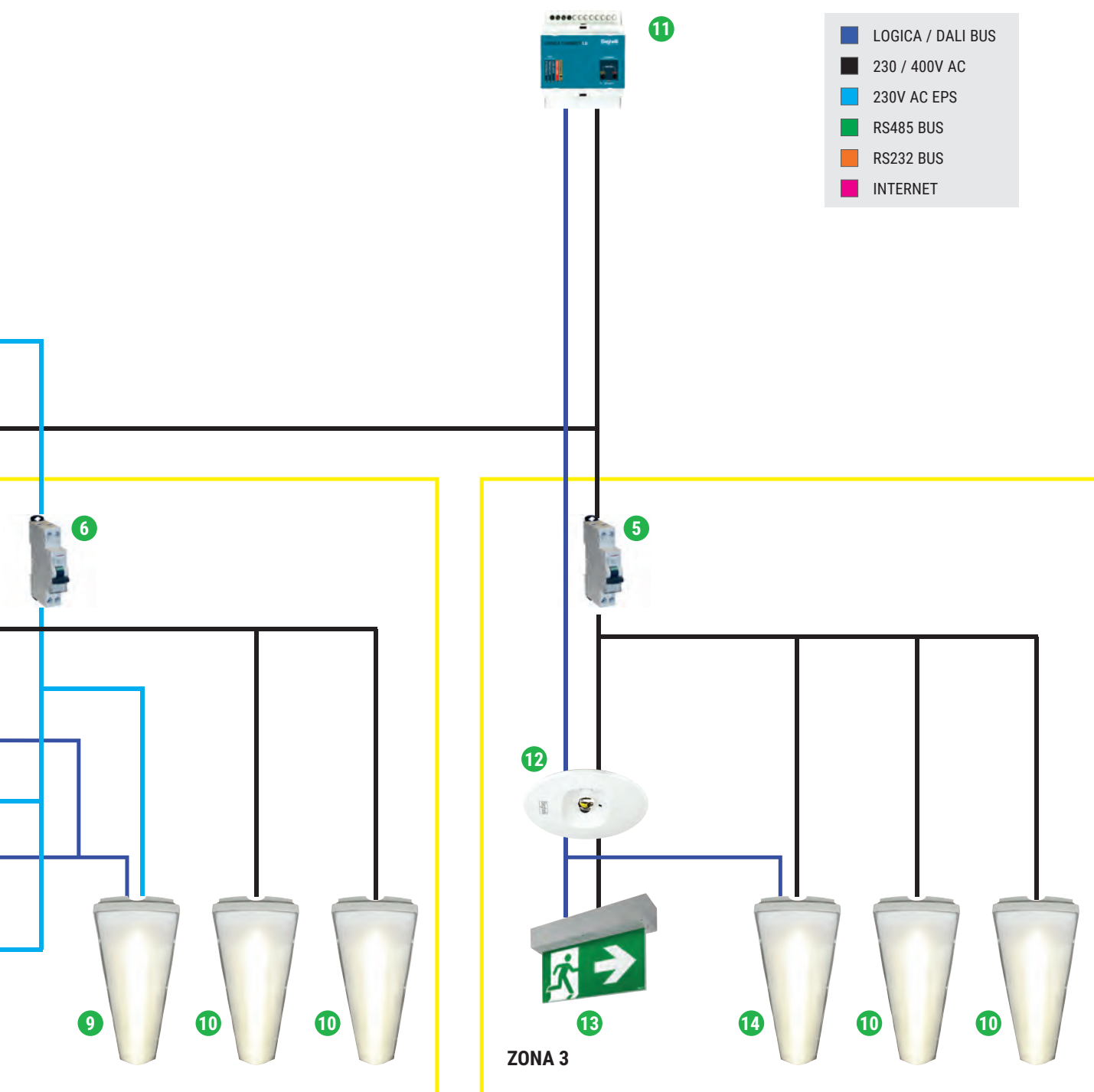

205 gruppi soccorritori / emergency power supply units



LG EPS ECO

1984
DISPOSITIVI

IP20

+40°C
0°C

BATTERY
+20°C
EN50171

Soccorritori EPS Eco caratterizzati da un elevato fattore di potenza (da 1000VAa 10kVA), alta efficienza ed affidabilità, vengono forniti con due uscite: SA, per alimentare un carico permanente, ed SE, alimentata solo in mancanza rete in ingresso. In caso di blackout la tensione sarà fornita dalle batterie ad entrambe le uscite dall'inverter. Ogni EPS Eco é dotato di contatto EPO (Emergency Power Off) per lo spegnimento da remoto.

EPS Eco characterized by a high power factor (from 1000VA to 10kVA), high efficiency and reliability, are supplied with two outputs: SA (maintained lighting), to power a permanent load, and SE (non-maintained lighting), powered only in the absence of the input mains. In the event of a blackout, the voltage will be supplied by the batteries to both outputs of the inverter. Each EPS Eco is equipped with EPO (Emergency Power Off) contact for remote shutdown.

BOX PER GRUPPO BATTERIE ESTERNO / BOX FOR EXTERNAL BATTERY PACKS

Il gruppo batterie esterno viene alloggiato in uno o più Box in lamiera nero opaco, dotati di prese d'aria per l'aerazione.
The external battery pack is housed in one or more matt black sheet metal boxes, equipped with air vents for ventilation.



Taglia Size	Dimensioni Soccorritore EPS Dimensions mm			Dimensioni Box Box Dimensions mm		
	H	B	L	L	B	H
S	220	145	282	450	450	610
M	220	145	347	780	450	610
L	576	250	592	950	470	1190

DATI TECNICI / TECHNICAL DATA

INGRESSO - INPUT	POTENZA NOMINALE NOMINAL POWER	1KVA	2KVA	3KVA	4KVA	6KVA	8KVA	10KVA
	TENSIONE VOLTAGE	220 / 230 / 240 V - 1 + N						
	FREQUENZA FREQUENCY	50 - 60Hz						
	FATTORE DI POTENZA POWER FACTOR	0.98						
USCITA - OUTPUT	TENSIONE NOMINALE NOMINAL TENSION	220 / 230 / 240 V - 1 + N						
	POTENZA NOMINALE NOMINAL POWER	1KVA	2KVA	3KVA	4KVA	6KVA	8KVA	10KVA
	POTENZA SECONDO POWER ACCORDING EN 50171	800W	1.6KW	2.4KW	3.2KW	4.8KW	6.4KW	8KW
	NUMERO FASI NUMBER OF PHASES	1 + N						
	FATTORE DI CRESTA (I _{picco} /I _{rms}) CREST FACTOR (I _{peak} /I _{rms})	3: 1						
	FORMA D'ONDA WAVEFORM	Sinusoidale Sinusoidal						
	STABILITÀ STATICA STATIC STABILITY	±3% in10ms						
	SOVRACCARICO OVERLOAD	Secondo (EN 50171): 120% per 1h According to (EN 50171): 120% for 1h						
ALTRE CARATTERISTICHE - OTHER CHARACTERISTICS	COLORE COLOR	RAL 9005						
	COMUNICAZIONE COMMUNICATION	RS232 + RS485 opzionale + scheda contatti puliti opzionale RS232 + RS485 optional + potential free contact board optional						
	CONFORMITÀ COMPLIANCE	EN 50171 / EN 620401:2008 / EN 62040 1-EC:2009 / EN 62040 1-A1:2013 Direttiva 2014/35/EU EN 50171 / EN 620401:2008 / EN 62040 1-EC:2009 / EN 62040 1-A1:2013 Directive 2014/35/EU						
	TEMPERATURA DI ESERCIZIO OPERATING TEMPERATURE	0 ÷ 40°C (CONSIGLIATO 20 ÷ 25°C) Batteria 20 ÷ 25°C 0 ÷ 40°C (RECOMMENDED 20 ÷ 25°C) Battery 20 ÷ 25°C						
	GRADO DI PROTEZIONE DEGREE OF PROTECTION	IP20						
	RUMOROSITÀ (a 1m) NOISE LEVEL (at 1m)	<50 dB (A)						
	UMIDITÀ RELATIVA EN 50171 RELATIVE HUMIDITY EN 50171	85% SENZA CONDENSA 85% WITHOUT CONDENSATION						
	ALTITUDINE MASSIMA MAXIMUM ALTITUDE	1000mt						

Taglia Size	Cod.	Descrizione Description	Potenza Power VA	Potenza attiva Active power W	Potenza secondo EN50171 Power according to EN50171 W	Batteria Battery	N° Batterie N. of batteries	Autonomia Autonomy h
S	17700K	EPS ECO SE/SA 1KVA 1P 1ELM	1000	900	800 VA / 800 W	55Ah	3	1
S	17701K	EPS ECO SE/SA 1KVA 2P 1ELM	1000	900	800 VA / 800 W	90Ah	3	2
S	17702K	EPS ECO SE/SA 1KVA 3P 1ELM	1000	900	800 VA / 800 W	120Ah	3	3
M	17703K	EPS ECO SE/SA 2KVA 1P 1ELM	2000	1800	1600 VA / 1600 W	55Ah	6	1
M	17704K	EPS ECO SE/SA 2KVA 2P 1ELM	2000	1800	1600 VA / 1600 W	90Ah	6	2
M	17705K	EPS ECO SE/SA 2KVA 3P 1ELM	2000	1800	1600 VA / 1600 W	120Ah	6	3
M	17706K	EPS ECO SE/SA 3KVA 1P 1ELM	3000	2700	2400 VA / 2400 W	70Ah	6	1
M	17707K	EPS ECO SE/SA 3KVA 2P 1ELM	3000	2700	2400 VA / 2400 W	120Ah	12	2
M	17708K	EPS ECO SE/SA 3KVA 3P 1ELM	3000	2700	2400 VA / 2400 W	90Ah	20	3
L	17709K	EPS ECO SE/SA 4KVA 1P 1ELM	4000	4000	3200 VA / 3200 W	28Ah	20	1
L	17710K	EPS ECO SE/SA 4KVA 2P 1ELM	4000	4000	3200 VA / 3200 W	55Ah	20	2
L	17711K	EPS ECO SE/SA 4KVA 3P 1ELM	4000	4000	3200 VA / 3200 W	70Ah	20	3
L	17712K	EPS ECO SE/SA 6KVA 1P 1ELM	6000	6000	4800 VA / 4800 W	45Ah	20	1
L	17713K	EPS ECO SE/SA 6KVA 2P 1ELM	6000	6000	4800 VA / 4800 W	70Ah	20	2
L	17714K	EPS ECO SE/SA 6KVA 3P 2ELM	6000	6000	4800 VA / 4800 W	100Ah	20	3
L	17715K	EPS ECO SE/SA 8KVA 1P 1ELM	8000	8000	6400 VA / 6400 W	55Ah	20	1
L	17716K	EPS ECO SE/SA 8KVA 2P 1ELM	8000	8000	6400 VA / 6400 W	90Ah	20	2
L	17717K	EPS ECO SE/SA 8KVA 3P 2ELM	8000	8000	6400 VA / 6400 W	120Ah	20	3
L	17718K	EPS ECO SE/SA 10KVA 1P 1ELM	10000	10000	8000 VA / 8000 W	90Ah	20	1
L	17719K	EPS ECO SE/SA 10KVA 2P 2ELM	10000	10000	8000 VA / 8000 W	120Ah	20	2
L	17720K	EPS ECO SE/SA 10KVA 3P 2ELM	10000	10000	8000 VA / 8000 W	70Ah	40	3

ACCESSORI / ACCESSORY



CENTRALE LG EPS LOG / CENTRALE LG EPS LOG

Dispositivo di test automatico secondo DIN EN 62034 per il monitoraggio e il controllo di apparecchi di segnalazione, apparecchi di sicurezza e moduli di controllo LG EPS.

Testing device for monitoring up to 64 exit sign luminaires and escape lighting luminaires with integrated monitoring and switching modules LG EPS.

90x105x74mm

Cod.	Descrizione Description	Peso / Weight Kg
16322	CENTRALE LG EPS LOG	0.2

LG EPS ECO

IP20

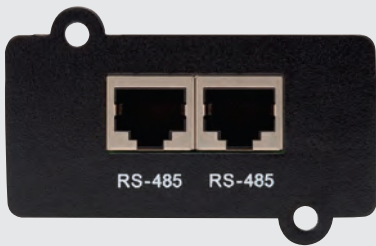

LG EPS ECO

MODULO RS485 LG EPS ECO / MODULE RS485 LG EPS ECO

Il convertitore di protocollo 16323 MODULO/RS485 LG EPS ECO consente la gestione dell'EPS tramite il protocollo MODBUS su linea seriale RS485.

The 16323 MODULE/RS485 LG EPS ECO protocol converter allows the management of the EPS via the MODBUS protocol on RS485 serial line.

Cod.	Descrizione Description	Peso / Weight Kg
16323	MODULO RS485 LG EPS ECO	0.1



LG EPS ECO

 26x151x75mm

CONVERTITORE RS232-RS485 / RS232-RS485 CONVERTER

Il convertitore RS232-RS485 consente di collegare i soccorritori EPS alla Centrale supervisione 12131C, permettendo la supervisione dei sistemi LG EPS.

The RS232-RS485 converter allows you to connect the EPS static inverter to the 12131C supervision unit, allowing the supervision of the LG EPS systems.

Cod.	Descrizione Description	Peso / Weight Kg
12134	CONVERTITORE DIN RS232-RS485	0.4

SEGUE / NEXT >

ACCESSORI / ACCESSORY



SWITCH LG EPS 500W / SWITCH LG EPS 500W

Monitor e comando lampada, funzionamento sia SA che SE. Carico: 2,5W - 500W, Tensione di esercizio: 198 - 254Vca / 50Hz, Tensione da batteria: 176÷276Vcc
 Monitor and lamp control, maintained (SA), non- maintained (SE) - Load: 2.5 W - 500 W, Operating voltage: 198 - 254Vac / 50Hz - Battery operating voltage: 176÷276VDC

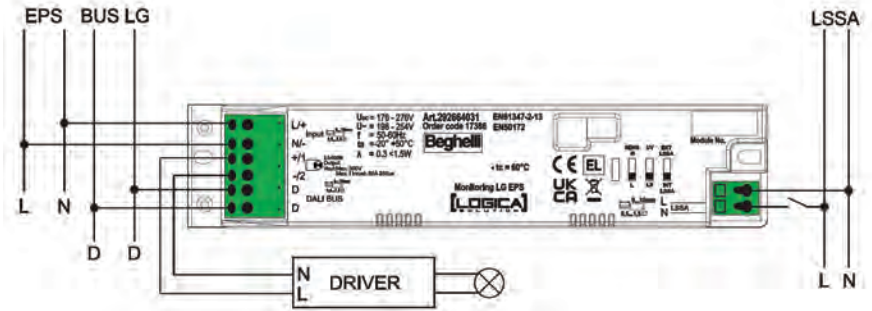

152x32x24mm

LG EPS ECO IP20

Cod.	Descrizione Description	Peso / Weight Kg
17386	SWITCH LG EPS 500W	0.2



MODULO LAMPADA TW 500 / SWITCH MODULE TW 500

Modulo di comando lampada, funzionamento ON/OFF. Carico: max. 500W, Tensione di esercizio: 230Vca / 50Hz, Tensione da batteria: 176÷276Vcc
 Module lamp control, ON/OFF operation - Load: max. 500 W, Operating voltage: 230Vac / 50Hz - Battery operating voltage: 176÷276VDC

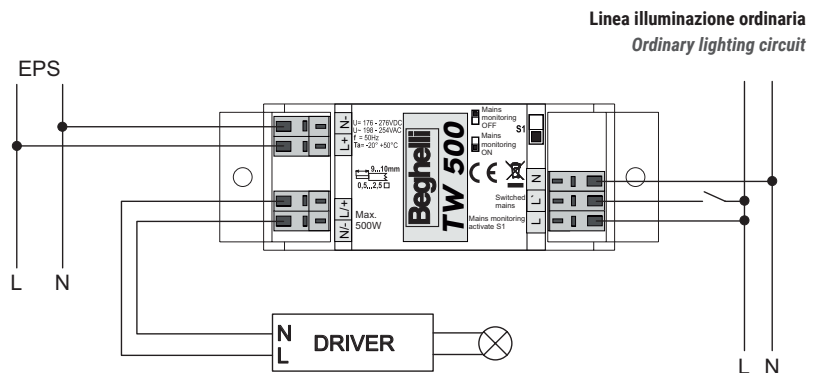

105x36x24mm

LG EPS ECO IP20

Cod.	Descrizione Description	Peso / Weight Kg
16324	MODULO LAMPADA TW 500	0.1



SENSORE DI RETE / MAINS MONITORING MODULE

Modulo di monitoraggio dell'alimentazione di rete per illuminazione ordinaria, attivazione del controllo di uscita in caso di errori di mancanza rete: $U < 85\%$ UNominale. per barra DIN.

Module for monitoring the mains supply of the general lighting in sub distributors. Activation of the control output during mains faults and mains failures with $U < 85\%$ UNominal. for DIN rail.

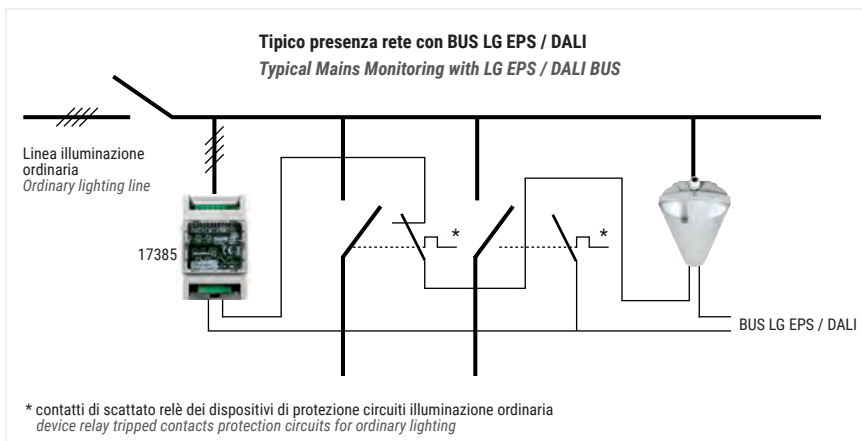

90x52x58mm

LG EPS ECO

IP20

Cod.	Descrizione Description	Peso / Weight Kg
17385	DS3-UV 1-3 PHASE MONITORING	0.2



Soccorritori EPS Pro caratterizzati da ingresso e uscita monofase e trifase, progettati in conformità con la normativa EN 50171 ed idonei per sovraccarichi continui fino al 120% del carico nominale dichiarato.

EPS Pro é dotato di interfaccia contatti puliti e protezione contro l'inversione della polarità delle batterie per garantire la massima sicurezza. Inoltre assicura livelli di carica con corrente elevata, permettendone la ricarica fino all'80% della piena autonomia entro 12 ore. La gamma EPS Pro è stata progettata per soddisfare le esigenze di potenze, da 2kVA a 40kVA.

EPS Pro characterized by single-phase and three-phase input and output, designed in compliance with EN 50171 and suitable for continuous overloads up to 120% of the declared nominal load. EPS Pro is equipped with a potential free contact and protection against battery polarity reversal to ensure maximum safety. It also ensures high current charging levels, allowing it to be recharged to 80% of full autonomy within 12 hours. The EPS Pro range has been designed to meet power needs, from 2kVA to 40kVA.

BOX PER GRUPPO BATTERIE ESTERNO BOX FOR EXTERNAL BATTERY PACKS

Il gruppo batterie esterno viene alloggiato in uno o più Box in lamiera RAL 7035, dotati di prese d'aria per l'aerazione.

The external battery pack is housed in one or more RAL 7035 sheet metal boxes, equipped with air vents for ventilation.

Taglia Size	Dimensioni Soccorritore EPS Dimensions mm		
	H	B	L
M	500	250	698
L	1320	440	840

DATI TECNICI / TECHNICAL DATA

INGRESSO - INPUT	POTENZA NOMINALE NOMINAL POWER	2KVA	3KVA	5KVA	6KVA	8KVA	10KVA	12KVA	15KVA	20KVA	25KVA	30KVA	35KVA	40KVA	
	TENSIONE VOLTAGE	220 / 230 / 240 V - 1 + N						220 / 230 / 240 V - 1 + N o / or			380 / 400 / 415 V - 3 + N				
	FREQUENZA FREQUENCY	50 - 60Hz													
	FATTORE DI POTENZA POWER FACTOR	0.99													
USCITA - OUTPUT	TENSIONE NOMINALE NOMINAL TENSION	220 / 230 / 240 V - 1 + N						220 / 230 / 240 V - 1 + N o / or			380 / 400 / 415 V - 3 + N				
	POTENZA NOMINALE NOMINAL POWER	2KVA	3KVA	5KVA	6KVA	8KVA	10KVA	12KVA	15KVA	20KVA	25KVA	30KVA	35KVA	40KVA	
	POTENZA SECONDO POWER ACCORDING EN 50171	1.6KVA	2.5KVA	4KVA	5KVA	6KVA	8KVA	10KVA	12KVA	16KVA	20KVA	24KVA	28KVA	32KVA	
	NUMERO FASI NUMBER OF PHASES	1 + N			1 + N o/ or 3 + N						3 + N3 + N				
	FATTORE DI CRESTA (I _{picco} /I _{rms}) CREST FACTOR (I _{peak} /I _{rms})	3 : 1													
	FORMA D'ONDA WAVEFORM	Sinusoidale Sinusoidal													
	STABILITÀ STATICA STATIC STABILITY	±3% in10ms													
	SOVRACCARICO OVERLOAD	secondo (EN 50171): 120% per 1h according to (EN 50171): 120% for 1h													
ALTRE CARATTERISTICHE - OTHER CHARACTERISTICS	COLORE COLOR	RAL 7035													
	COMUNICAZIONE COMMUNICATION	RS232/485 con MODBUS + slot per interfaccia SNMP + slot per scheda contatti puliti RS232/485 with MODBUS + SNMP interface slot + potential free contact board slot													
	CONFORMITÀ COMPLIANCE	EN 50171 / EN 620401:2008 / EN 62040 1-EC:2009 / EN 62040 1-A1:2013 Direttiva 2014/35/EU EN 50171 / EN 620401:2008 / EN 62040 1-EC:2009 / EN 62040 1-A1:2013 Directive 2014/35/EU													
	TEMPERATURA DI ESERCIZIO OPERATING TEMPERATURE	0 ÷ 40°C (CONSIGLIATO 20 ÷ 25°C) Batteria 20 ÷ 25°C 0 ÷ 40°C (RECOMMENDED 20 ÷ 25°C) Battery 20 ÷ 25°C													
	GRADO DI PROTEZIONE DEGREE OF PROTECTION	IP20													
	RUMOROSITÀ (a 1m) NOISE LEVEL (at 1m)	<48 dB (A)													
	UMIDITÀ RELATIVA EN 50171 RELATIVE HUMIDITY EN 50171	85% SENZA CONDENSA 85% WITHOUT CONDENSATION													
	ALTITUDINE MASSIMA MAXIMUM ALTITUDE	1000mt													

Taglia Size	Cod.	Descrizione Description	Potenza Power VA	Potenza attiva Active power W	Potenza secondo EN50171 Power according to EN50171 W	Batteria Battery	N° Batterie N. of batteries	Autonomia Autonomy h
M	30150K1-2	EPS PRO 2KVA 1M 1H	2000	2000	1600 VA / 1600 W	20Ah	15	1
M	30150K2-2	EPS PRO 2KVA 1M 2H	2000	2000	1600 VA / 1600 W	45Ah	15	2
M	30150K3-2	EPS PRO 2KVA 1M 3H	2000	2000	1600 VA / 1600 W	28Ah	30	3
M	30150K1-3	EPS PRO 3KVA 1M 1H	3000	3000	2500 VA / 2500 W	33Ah	15	1
M	30150K2-3	EPS PRO 3KVA 1M 2H	3000	3000	2500 VA / 2500 W	28Ah	30	2
M	30150K3-3	EPS PRO 3KVA 1M 3H	3000	3000	2500 VA / 2500 W	45Ah	30	3
M	30151K1	EPS PRO 5KVA 1M 1H	5000	5000	4000 VA / 4000 W	28Ah	30	1
M	30151K2	EPS PRO 5KVA 1M 2H	5000	5000	4000 VA / 4000 W	45Ah	30	2
L	30152K1	EPS PRO 6KVA 1M 3T 1H	6000	6000	5000 VA / 5000 W	12Ah	80	1
L	30152K2	EPS PRO 6KVA 1M 3T 2H	6000	6000	5000 VA / 5000 W	45Ah	40	2
L	30152K3	EPS PRO 6KVA 1M 3T 3H	6000	6000	5000 VA / 5000 W	55Ah	40	3
L	30153K1	EPS PRO 8KVA 1M 3T 1H	8000	8000	6000 VA / 6000 W	28Ah	40	1
L	30153K2	EPS PRO 8KVA 1M 3T 2H	8000	8000	6000 VA / 6000 W	55Ah	40	2
L	30153K3	EPS PRO 8KVA 1M 3T 3H	8000	8000	6000 VA / 6000 W	70Ah	40	3
L	30154K1	EPS PRO 10KVA 1M 3T 1H	10000	10000	8000 VA / 8000 W	33Ah	40	1
L	30154K2	EPS PRO 10KVA 1M 3T 2H	10000	10000	8000 VA / 8000 W	70Ah	40	2
L	30154K3	EPS PRO 10KVA 1M 3T 3H	10000	10000	8000 VA / 8000 W	90Ah	40	3
L	30155K1	EPS PRO 12KVA 1M 3T 1H	12000	12000	10000 VA / 10000 W	45Ah	40	1
L	30155K2	EPS PRO 12KVA 1M 3T 2H	12000	12000	10000 VA / 10000 W	70Ah	40	2
L	30155K3	EPS PRO 12KVA 1M 3T 3H	12000	12000	10000 VA / 10000 W	55Ah	80	3
L	30156K1	EPS PRO 15KVA 1M 3T 1H	15000	15000	12000 VA / 12000 W	55Ah	40	1
L	30156K2	EPS PRO 15KVA 1M 3T 2H	15000	15000	12000 VA / 12000 W	100Ah	40	2
L	30156K3	EPS PRO 15KVA 1M 3T 3H	15000	15000	12000 VA / 12000 W	70Ah	80	3
L	30157K1	EPS PRO 20KVA 1M 3T 1H	20000	20000	16000 VA / 16000 W	70Ah	40	1
L	30157K2	EPS PRO 20KVA 1M 3T 2H	20000	20000	16000 VA / 16000 W	70Ah	80	2
L	30157K3	EPS PRO 20KVA 1M 3T 3H	20000	20000	16000 VA / 16000 W	90Ah	80	3
L	30158K1	EPS PRO 10KVA 3T 1H	10000	10000	8000 VA / 8000 W	33Ah	40	1
L	30158K2	EPS PRO 10KVA 3T 2H	10000	10000	8000 VA / 8000 W	70Ah	40	2
L	30158K3	EPS PRO 10KVA 3T 3H	10000	10000	8000 VA / 8000 W	90Ah	40	3
L	30159K1	EPS PRO 12KVA 3T 1H	12000	12000	10000 VA / 10000 W	45Ah	40	1
L	30159K2	EPS PRO 12KVA 3T 2H	12000	12000	10000 VA / 10000 W	70Ah	40	2
L	30159K3	EPS PRO 12KVA 3T 3H	12000	12000	10000 VA / 10000 W	55Ah	80	3
L	30160K1	EPS PRO 15KVA 3T 1H	15000	15000	12000 VA / 12000 W	55Ah	40	1
L	30160K2	EPS PRO 15KVA 3T 2H	15000	15000	12000 VA / 12000 W	100Ah	40	2
L	30160K3	EPS PRO 15KVA 3T 3H	15000	15000	12000 VA / 12000 W	70Ah	80	3
L	30161K1	EPS PRO 20KVA 3T 1H	20000	20000	16000 VA / 16000 W	70Ah	40	1
L	30161K2	EPS PRO 20KVA 3T 2H	20000	20000	16000 VA / 16000 W	70Ah	80	2
L	30161K3	EPS PRO 20KVA 3T 3H	20000	20000	16000 VA / 16000 W	90Ah	80	3
L	30162K1	EPS PRO 25KVA 3T 1H	25000	25000	20000 VA / 20000 W	55Ah	80	1
L	30162K2	EPS PRO 25KVA 3T 2H	25000	25000	20000 VA / 20000 W	55Ah	120	2
L	30162K3	EPS PRO 25KVA 3T 3H	25000	25000	20000 VA / 20000 W	70Ah	120	3
L	30163K1	EPS PRO 30KVA 3T 1H	30000	30000	24000 VA / 24000 W	55Ah	80	1
L	30163K2	EPS PRO 30KVA 3T 2H	30000	30000	24000 VA / 24000 W	100Ah	80	2
L	30163K3	EPS PRO 30KVA 3T 3H	30000	30000	24000 VA / 24000 W	90Ah	120	3
L	30164K1	EPS PRO 35KVA 3T 1H	35000	35000	28000 VA / 28000 W	70Ah	80	1
L	30164K2	EPS PRO 35KVA 3T 2H	35000	35000	28000 VA / 28000 W	70Ah	120	2

CTS

	Taglia Size	Cod.	Descrizione Description	Potenza Power VA	Potenza attiva Active power W	Potenza secondo EN50171 Power according to EN50171 W	Batteria Battery	N° Batterie N. of batteries	Autonomia Autonomy h
CTS	L	30164K3	EPS PRO 35KVA 3T 3H	35000	35000	28000 VA / 28000 W	100Ah	120	3
	L	30165K1	EPS PRO 40KVA 3T 1H	40000	40000	32000 VA / 32000 W	100Ah	80	1
	L	30165K2	EPS PRO 40KVA 3T 2H	40000	40000	32000 VA / 32000 W	90Ah	120	2
	L	30165K3	EPS PRO 40KVA 3T 3H	40000	40000	32000 VA / 32000 W	90Ah	160	3

ACCESSORI / ACCESSORY



LG EPS PRO

IP20

CENTRALE LG EPS LOG / CENTRALE LG EPS LOG

Dispositivo di test automatico secondo DIN EN 62034 per il monitoraggio e il controllo di apparecchi di segnalazione, apparecchi di sicurezza e moduli di controllo LG EPS.

Testing device for monitoring up to 64 exit sign luminaires and escape lighting luminaires with integrated monitoring and switching modules LG EPS.

Cod.	Descrizione Description	Peso / Weight Kg
16322	CENTRALE LG EPS LOG	0.2

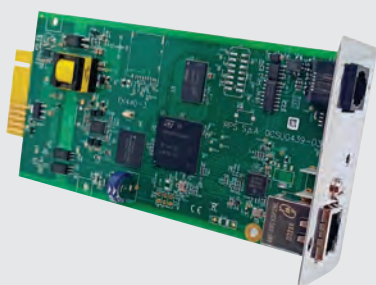

LG EPS PRO

SCHEDA DI RETE LAN TCP -IP / LAN TCP-IP NETWORK CARD

SCHEDA DI RETE LAN TCP /IP LG EPS consente la gestione dell'EPS collegato direttamente su LAN 10/100/1000 Mb utilizzando i principali protocolli di comunicazione di rete (TCP /IP). È la soluzione ideale per l'integrazione degli EPS su reti ethernet o BMS con protocolli Modbus/TCP, BACnet/IP e Software di monitoraggio.

LG EPS LAN TCP/IP NETWORK CARD allows EPS directly connected over LAN 10/100/1000 Mb connections to be managed using the main network communication protocols (TCP / IP). It is the ideal solution for the integration of EPS over Ethernet networks or BMS with Modbus/TCP or BACNET/IP protocols.

Cod.	Descrizione Description	Peso / Weight Kg
30170	SCHEDA RETE LAN TCP/IP LG EPS	0.2



SENSORE DI RETE / MAINS MONITORING MODULE

Modulo di monitoraggio dell'alimentazione di rete per illuminazione ordinaria, attivazione del controllo di uscita in caso di errori di mancanza rete: $U < 85\% U_{Nominale}$. per barra DIN.

Module for monitoring the mains supply of the general lighting in sub distributors. Activation of the control output during mains faults and mains failures with $U < 85\% U_{Nominal}$. for DIN rail.

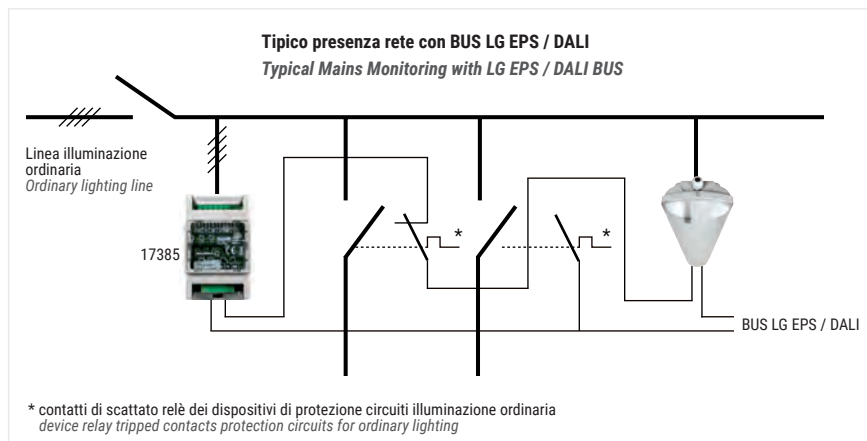

90x52x58mm

LG EPS PRO

IP20

Cod.	Descrizione Description	Peso / Weight Kg
17385	DS3-UV 1-3 PHASE MONITORING	0.2



CONVERTITORE RS232-RS485 / RS232-RS485 CONVERTER

Il convertitore RS232-RS485 consente di collegare i soccorritori EPS alla Centrale supervisione 12131C, permettendo la supervisione dei sistemi LG EPS.

The RS232-RS485 converter allows you to connect the EPS static inverter to the 12131C supervision unit, allowing the supervision of the LG EPS systems.

LG EPS PRO

26x151x75mm

Cod.	Descrizione Description	Peso / Weight Kg
12134	CONVERTITORE DIN RS232-RS485	0.4



SWITCH LG EPS 500W / SWITCH LG EPS 500W

Monitor e comando lampada, funzionamento sia SA che SE. Carico: 2,5W - 500W, Tensione di esercizio: 198 - 254Vca / 50Hz, Tensione da batteria: 176÷276Vcc
 Monitor and lamp control, maintained (SA), non- maintained (SE) - Load: 2.5 W - 500 W, Operating voltage: 198 - 254Vac / 50Hz - Battery operating voltage: 176÷276VDC

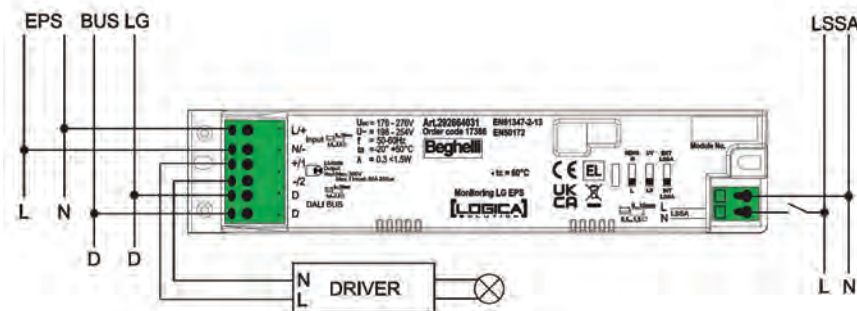

152x32x24mm

LG EPS PRO

IP20

Cod.	Descrizione Description	Peso / Weight Kg
17386	SWITCH LG EPS 500W	0.2



MODULO LAMPADA TW 500 / SWITCH MODULE TW 500

Modulo di comando lampada, funzionamento ON/OFF. Carico: max. 500W, Tensione di esercizio: 230Vca / 50Hz, Tensione da batteria: 176÷276Vcc
 Module lamp control, ON/OFF operation - Load: max. 500 W, Operating voltage: 230Vac / 50Hz - Battery operating voltage: 176÷276VDC

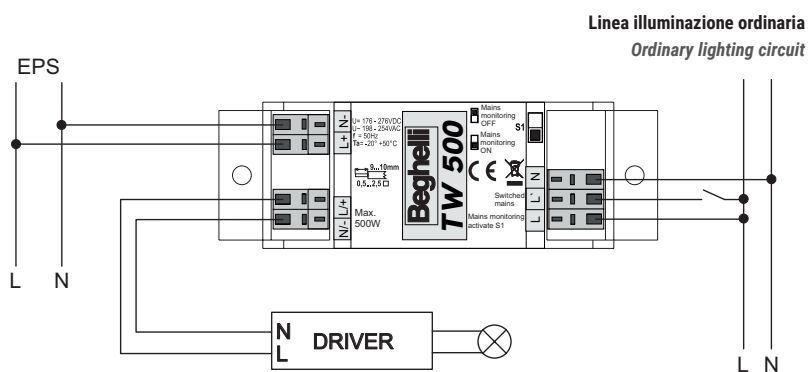

105x36x24mm

LG EPS PRO

IP20

Cod.	Descrizione Description	Peso / Weight Kg
16324	MODULO LAMPADA TW 500	0.1

ACCESSORI / ACCESSORY



SWITCH EMERGENZA / EMERGENCY SWITCH

L'accessorio ESM (Emergency Switch Module) è necessario ogni qual volta vi sia la necessità di avere una parte del carico sempre alimentata ed una parte alimentata solamente durante la mancanza rete. Lo scopo dell'accessorio opzionale ESM è di fornire un sezionamento del carico mediante comando automatico/manuale. È possibile collegare fino a 4 dispositivi EMS per ogni EPS effettuando la ripartizione del carico totale su più linee. Il dispositivo usato in combinazione con un EPS realizza un sistema di continuità per apparecchiature d'emergenza con doppia tipologia d'uscita (SA, SE) conforme alla normativa EN 50171.

The ESM (Emergency Switch Module) accessory is necessary whenever there is a need a part of the load always powered and a part powered only during mains failure. The purpose of the optional ESM accessory is to provide load shedding via automatic/manual control. It is possible to connect up to 4 EMS devices for each static inverter, dividing the total load over multiple lines. The device used in combination with a static inverter creates a continuity system for emergency equipment with double type of output (Maintained, non-maintained) compliant with EN 50171.

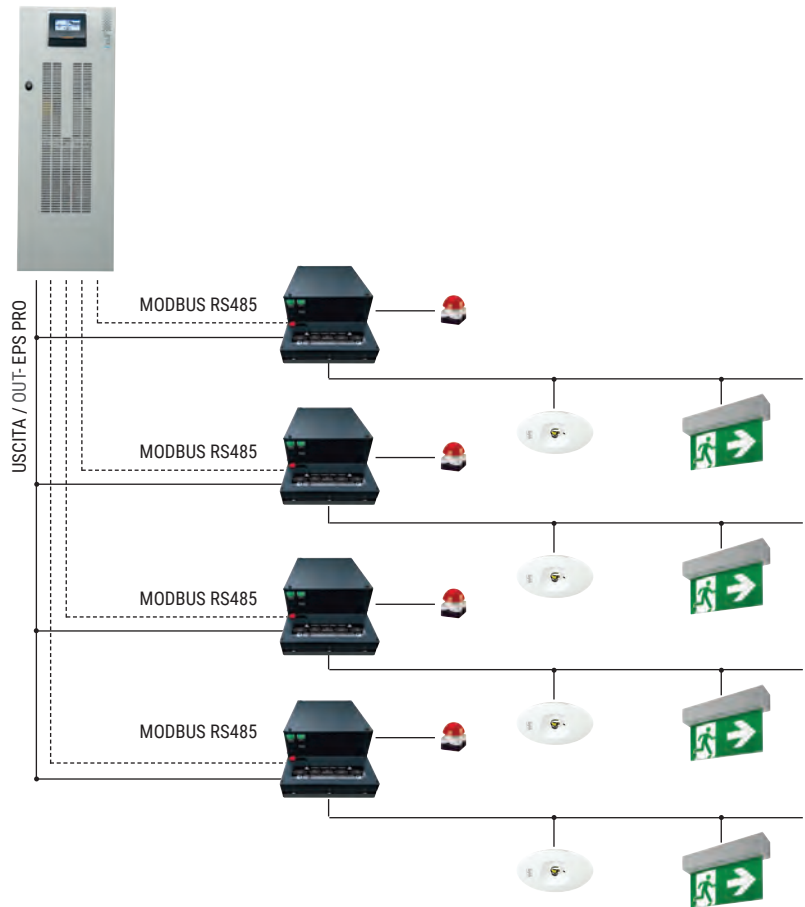

330x561,5x198mm

LG EPS PRO IP20

Cod.	Descrizione Description	Peso / Weight Kg
30166	ESM 25 KVA 1-PHASE	15
30167	ESM 25 KVA 3-PHASE	15
30168	ESM 50 KVA 3-PHASE	18
30169	ESM 100 KVA 3-PHASE	21

Legenda simboli

CARATTERISTICHE GENERALI: SIGNIFICATO DEI SIMBOLI

SIMBOLO	DESCRIZIONE	SIMBOLO	DESCRIZIONE
	Piattaforma Beghelli cloud unica per la gestione remota di tutti gli impianti di illuminazione ed illuminazione di emergenza.		Apparecchi ibridi per illuminazione di emergenza della serie SanificaAria che integrano un sistema di sanificazione dell'aria a cella di flusso UV-C.
	Dispositivo gestibile direttamente da APP B.connect : consente la comunicazione ottica verso l'apparecchio e la connessione WiFi locale verso la centrale. Permette inoltre di accedere direttamente alla piattaforma NuBe Beghelli Cloud.		Apparecchi della serie ArchitecturalEco, una linea di emergenza dal design particolarmente evoluto destinato al mondo dei lighting designer e realizzata con materiali interamente rinnovabili o riciclati e materie prime compostabili.
	Apparecchi autoalimentati Tradizionali con diagnosi locale sulle batterie e autonomia regolabile agendo sul circuito.		Apparecchi dotati di sensore di presenza per l'attivazione automatica dell'illuminazione.
	Apparecchi autoalimentati con diagnosi locale completa AutoTest e autonomia regolabile in locale o da APP.		Apparecchi idonei per applicazioni architettrurali, dotati di trattamento superficiale che ne permette la verniciabilità con normali pitture murarie.
	Apparecchi autoalimentati con diagnosi centralizzata CentralTest , con tecnologia di comunicazione che utilizza i cavi di alimentazione 230V. Integrando i relativi Moduli LG, LGFM o DALI, l'apparecchio commuta il protocollo di comunicazione e la tipologia di centrale compatibile. In assenza di collegamento ad una centrale gli apparecchi funzionano in modalità AutoTest.		Grado di protezione da fattori esterni secondo CEI EN 60598-1. Nel caso sia doppio, evidenzia due versioni dell'apparecchio o un accessorio opzionale specifico.
	Apparecchi con batteria e diagnosi centralizzata CentralSystem , alimentati da Centrale con una tensione di 216Vdc (LG230) o 24V(LG24).		Grado di protezione all'urto secondo CEI EN 50102.
	Apparecchi alimentati da tensione di rete , da EPS o da sistema LG230.		Temperatura di resistenza del apparecchio alla prova del Filo incandescente secondo CEI EN 60598-1.
	Funzione Rest Mode per abilitare l'inibizione dell'emergenza in apparecchi per illuminazione di emergenza o segnaletica.		Campo di temperatura generale in cui l'apparecchio mantiene correttamente le sue caratteristiche. Per il dettaglio delle caratteristiche di ogni singolo prodotto fare riferimento al Catalogo elettronico presente nel sito www.beghelli.it .
	Apparecchi CT autoalimentati con diagnosi centralizzata controllati da BUS Logica .		Apparecchi in cui la protezione contro la scossa elettrica è garantita per costruzione in Classe di Isolamento II.
	Apparecchi CT autoalimentati con diagnosi centralizzata a controllo remoto via radio , senza nessun collegamento BUS filare.		Apparecchi in cui la protezione contro la scossa elettrica è garantita per costruzione in Classe di Isolamento III.
	Apparecchi CT per illuminazione di emergenza che utilizzano per la comunicazione un BUS DALI .		Marchio di qualità europeo. Certificazione volontaria a testimoniare la qualità del prodotto e della filiera produttiva.
	Apparecchi CTS per illuminazione di emergenza ad alimentazione centralizzata a 230V . Diagnosi e comando degli apparecchi centralizzati.		Apparecchio destinato ad un utilizzo in ambienti con pericolo di esplosione per presenza di sostanze esplosive (polvere e/o gas...) secondo Direttiva ATEX .
	Apparecchi CTS per illuminazione di emergenza ad alimentazione centralizzata a 24V . Diagnosi e comando degli apparecchi centralizzati.		Batteria supplementare integrabile negli apparecchi di emergenza, senza intervenire sul cablaggio, che aumenta il flusso luminoso emesso fino ad oltre il 50% . Nel caso degli Inverter agisce raddoppiando l'autonomia.
	Batteria di nuova generazione con efficienza elevata anche in condizioni estreme. Grazie alle particolari caratteristiche dell'accumulatore, gli apparecchi che lo integrano usufruiscono di una garanzia di 10 anni su tutti i componenti , batteria compresa.		

Key to symbols

GENERAL CHARACTERISTICS: MEANING OF SYMBOLS

SYMBOL	DESCRIPTION	SYMBOL	DESCRIPTION
	Single cloud platform for the remote management of all lighting and emergency lighting systems.		Hybrid emergency lighting luminaires from the SanificaAria series, incorporating a UV-C flow cell air sanitisation system.
	Control Unit or Luminaire manageable directly by from the B.connect APP : it enables optical communications to the luminaire and local WiFi connections to the control unit. It also allows direct access to the NuBe cloud platform.		Luminaires from the ArchitecturalEco series, an emergency range with a particularly evolved design, intended for the world of lighting designers and made from entirely renewable and compostable raw materials.
TR	Self-contained luminaires with diagnostics on the batteries and adjustable autonomy on the circuit.		Luminaires with a motion sensor for automatic lighting activation.
AT	Self-contained luminaires with local diagnostics, AutoTest series and autonomy adjustable locally or via APP.		Luminaires suitable for architectural applications, with a surface treatment that allows them to be painted with normal wall paints.
CT	Self-contained luminaires with CentralTest centralized diagnosis, with communication technology that uses BUS 230V. By integrating the relevant LG, LGFM or DALI modules, the device switches the communication protocol and the type of compatible control unit. In the absence of control unit connection the luminaires operate in AutoTest mode.	IP65	Protection rating against external factors according to EN 60598-1. If it is double, highlight two versions of the luminaire or a specific optional accessory.
CTS	Luminaires with battery and CentralSystem centralized diagnosis, powered by the control unit with a voltage of 216Vdc (LG230) or 24V (LG24).	IK09	Protection rating against impact according to EN 50102.
HT	Emergency luminaires with 230V mains power , EPS centralised power supply or LG230 system.		Resistance temperature of the luminaire at the Glow Wire Test according to IEC EN 60598-1.
RM	Device for enabling the Rest Mode function on emergency luminaires		General temperature range in which the luminaire maintains correctly its characteristics. For details of the characteristics of each individual product, please refer to the electronic catalogue at www.beghelli.it .
LG	Self-contained luminaires with centralised diagnostics via BUS Logica (LG).		Luminaires protection against electric shock is guaranteed by an Insulation Class II built.
LGFM	Self-contained CT luminaires with centralised radio remote control , without any wired BUS connection.	III	Luminaires protection against electric shock is guaranteed by construction in Insulation Class III.
DALI	Emergency CT luminaires interfaced with DALI communication BUS .		European quality label. Voluntary certification to testify to the quality of the product and the production chain.
LG230	CTS Emergency luminaires with centralised 230V power supply. Diagnostics and control of the centralised luminaires.		Luminaire intended for use in areas where there is a risk of explosion due to the presence of explosive substances (dust and/or gas...) according to the ATEX Directive .
LG24	CTS Emergency luminaires with centralised 24V power supply. Diagnostics and control of the centralised luminaires.	BOOSTER BATTERY	Additional battery integrated into emergency luminaires, without change wiring, which increases the luminous flux emitted by up to over 50% . In the case of Inverters increases autonomy.
	New generation battery with high efficiency even in extreme conditions. Thanks to the particular characteristics of the battery, the luminaires that integrate it benefit from a 10-years warranty on all components , including the battery.		

Indice analitico

APPARECCHI / LUMINAIRES

Cod.	Descrizione	Pag.	Cod.	Descrizione	Pag.	Cod.	Descrizione	Pag.
1499	STILE IN LED 11W SE 6 LF	87	4405	PRATICA IP42 500L SA AT	59	17878	L.LARGA DWRC LGS230	99
4200	COMPLETA LED 8W CT SE LF	63	4410	BLU 120 1.5/3h IP42 SE	59	17879	L.LARGA DWRC LGS24 LS-UV	114
4201	COMPLETA LED 11W CT SE LF	63	4411	BLU 300 1.5/3h IP42 SE	59	17880	DOT AE LG230 IP65	114
4202	COMPLETA LED 24W CT SE LF	63	4412	BLU 500 1.5/3h IP42 SE	59	17881	DOT AE LGS24 IP65	114
4203	COMPLETA LED 11W CT SA LF	63	4421	BLU 300 1.5/3h IP42 SA/SE	59	17882	DOT AE HT IP65	129
4204	COMPLETA LED 24W CT SA LF	63	4422	BLU 500 1.5/3h IP42 SA/SE	59	17890	IRONFLAG LG230 20M	129
4205	COMPLETA LED 36W CT SE LF	63	4430	BLU 120 AT IP42 SE	59	17891	IRONFLAG LG230 30M	129
4206	COMPLETA LED 36W CT SA LF	63	4431	BLU 300 AT IP42 SE	59	17892	IRONFLAG PEND LGS230 20M	129
4210	COMPLETA LED 8W AT SE LIFE	63	4432	BLU 500 AT IP42 SE	59	17893	IRONFLAG PEND LGS230 30M	129
4211	COMPLETA LED 24W AT SE LIFE	63	4441	BLU 300 AT IP42 SA/SE	121	17894	IRONFLAG LGS24 20M	129
4212	COMPLETA LED 36W AT SE LIFE	63	4602	FRUTTOLUCE2 LED SE/SA 1N	121	17895	IRONFLAG LGS24 30M	129
4213	COMPLETA LED 24W AT SA LIFE	63	4603	FRUTTOLUCE3 LED SE/SA 1N	121	17896	IRONFLAG PEND LGS24 20M	129
4214	COMPLETA LED 36W AT SA LIFE	63	4605	FRUTTOLUCE6 LED SE/SA 1N	119	17897	IRONFLAG PEND LGS24 30M	129
4300	UP LED 6-8W SE 1.5/3 IP65 LF	67	4607	TUTTIFRUTTI 2-3 LED SE 2H	119	17898	IRONFLAG HT 20M	129
4301	UP LED 11-24W SE 1.5/3 IP65 LF	67	4609	TUTTIFRUTTI 6 LED SE 2H	123	17899	IRONFLAG HT 30M	129
4302	UP LED 24-36W SE 1/3 IP65 LF	67	4611	EM503 LED SE2H	81	17900	IRONFLAG PEND HT 20M	129
4303	UP LED 11-24W SA 1.5/3 IP65 LF	67	8584	TICINQUE IP42 LED 18W SE 6LF	81	17901	IRONFLAG PEND HT 30M	117
4304	UP LED 24-36W SA 1/3 IP65 LF	67	8585	TICINQUE IP42 LED 18W SA 8LF	81	17908	DESIGN FLAG SX LGS230	117
4320	EXIT DF20M SA 1/2/3H RM LF	133	8586	TICINQUE IP65 LED 18W SE 6LF	81	17909	DESIGN FLAG SX LGS24	117
4321	EXIT DF30M SA 1/2/3H RM LF	133	8587	TICINQUE IP65 LED 18W SA 8LF	81	17910	DESIGN FLAG SX HT	117
4322	EXIT DF60M SA 1/2/3H RM LF	133	8590	GRANLUCE T5 LED IP65 SE 2LF	81	17911	EXIT LGS230 DF20M	133
4330	MULTI LENS 60MM SE 1H RM	103	8591	GRANLUCE T5 LED IP65 SA 2LF	81	17912	EXIT LGS230 DF30M	133
4331	MULTI LENS 60MM SE 3H RM	103	8592	G.LUCE T5 LED AT AR IP65 SE LF	81	17913	EXIT LGS230 DF60M	133
4334	MULTI LENS GL 60MM SA 123H RM	103	8593	G.LUCE T5 LED AT AR IP65 SA LF	85	17914	EXIT LGS24 DF20M	133
4335	MULTI LENS GL 60MM SA 236H RM	103	8594	T5 TUTTOLED IP42 18 SE 3/6LF	81	17915	EXIT LGS24 DF30M	133
4370	UPLD 1124W IP65 CT SE LTO	67	8597	GRANLUCE T5 LED IP65 SE 1LF	81	17916	EXIT LGS24 DF60M	133
4371	UPLD 2436W IP65 CT SE LTO	67	8598	GRANLUCE T5 LED IP65 SA 1LF	23	17917	EXIT HT DF20M	133
4372	UPLD 1124W IP65 CT SA LTO	67	12182	LOG LED LG 8W SE 2/4/6P 750LM	23	17918	EXIT HT DF30M	133
4373	UPLD 2436W IP65 CT SA LTO	67	12185	LOG LED LG 8W SA 2/4/6N 750LM	23	17919	EXIT HT DF60M	34
4374	UPLD 1124W IP65 AT SE LF	67	12186	LOG LED LG11WSA 1.5/3/4N 900LM	23	17920	P.MODULA 1500 REG IP65 HT/CTS	30
4375	UPLD 2436W IP65 AT SE LF	67	12187	LOG LED LG 24WSA 1/2/3N 1100LM	27	17923	MATRIX 1500 REG IP65 HT/CTS	127
4376	UPLD 1124W IP65 AT SA LF	67	15030	ACC EM LED 24 CT SA LF	27	17924	IRONFLAG IP65 LGS230 30M	127
4377	UPLD 2436W IP65 AT SA LF	67	15032	ACC EM LED GL CT SE	23	17925	IRONFLAG IP65 LGS24 30M	127
4380	EXIT DF20M CT SA LF	133	17403	LOGICA LED HT 8W	23	17926	IRONFLAG IP65 HT 30M	117
4381	EXIT DF30M CT SA LF	133	17404	LOGICA LED HT 11W	23	17930	DESIGN FLAG DX LGS230	117
4382	EXIT DF60M CT SA LF	133	17405	LOGICA LED HT 24W	23	17931	DESIGN FLAG BASSO LGS230	117
4383	IRONFLAG IP65 30M SE/SA	127	17406	LOGICA LED HT 36W	55	17932	DESIGN FLAG ALTO LGS230	117
4384	IRONFLAG IP65 CT 30M SE/SA	103	17423	METRICA LED HT L	55	17933	DESIGN FLAG DX LGS24	117
4390	MULTI LENS CT SE LF	103	17424	METRICA LED HT XL	50	17934	DESIGN FLAG BASSO LGS24	117
4391	MULTI LENS CT SA LF	103	17435	F65 LED 8W HT IP65	50	17935	DESIGN FLAG ALTO LGS24	117
4393	MULTI LENS GL CT SA LF	77	17436	F65 LED 11W HT IP65	50	17936	DESIGN FLAG DX HT	117
4400	PRATICA IP42 200L 1/1.5/3 SATR	77	17437	F65 LED 24W HT IP65	50	17937	DESIGN FLAG BASSO HT	117
4401	PRATICA IP42 300L 1.5/3 SATR	77	17438	F65 LED 36W HT IP65	27	17938	DESIGN FLAG ALTO HT	117
4402	PRATICA IP42 500L 1.5/3 SATR	77	17452	ACCIAIO E LED HT GL	95	18400	DESIGN FLAG SX SE/SA TR RM	117
4403	PRATICA IP42 200L SA AT	77	17876	L.LARG DWCL LGS230	95	18401	DESIGN FLAG SX SE/SA CT LF	117
4404	PRATICA IP42 300L SA AT	77	17877	L.LARGA DWCL LGS24 LS-UV	99	18402	DESIGN FLAG DX SE/SA TR RM	117

Analytical index

APPARECCHI / LUMINAIRES

Cod.	Descrizione	Pag.	Cod.	Descrizione	Pag.	Cod.	Descrizione	Pag.
18403	DESIGN FLAG BASSO SE/SA TR RM	117	19329	L.LARG DWCL CT 24W GL SA LF	99	19800	IRONFLAG 20M SA RM	129
18404	DESIGN FLAG ALTO SE/SA TR RM	117	19330	L.LARG DWRC HT 24W	99	19801	IRONFLAG 30M SA RM	129
18405	DESIGN FLAG DX SE/SA CT LF	117	19338	LLARG DWRC CT 24W SA LF	99	19802	IRONFLAG PEND 20M SA RM	129
18406	DESIGN FLAG BASSO SE/SA CT LF	117	19339	LLARG DWRC CT 24W GL SA LF	153	19803	IRONFLAG PEND 30M SA RM	129
18407	DESIGN FLAG ALTO SE/SA CT LF	117	19358	INV P&L LED SE/SA 1H 20-60V	153	19810	IRONFLAG CT 20M SA LF	129
18600	P.MODULA 150 IP42 SE RM	33	19359	INV P&L LED SE/SA 3H 20-60V	153	19811	IRONFLAG CT 30M SA LF	129
18601	P.MODULA 150 IP42 SA/SE RM	33	19367	INV P&L LED SE/SA 1H 60-180V	153	19812	IRONFL PEND CT 20M SA LF	129
18610	P.MODULA 300 IP42 SE RM	33	19368	INV P&L LED SESA3H 20-60V IP65	91	19813	IRONFL PEND CT 30M SA LF	127
18611	P.MODULA 300 IP42 SA/SE RM	33	19370	LUNGALARGALUCE EX CT SE/SA LF	153	19818	IRONFLAG IP65 AT 30M SE/SA	141
18620	P.MODULA 500 IP42 SE RM	33	19371	INV P&L LED SE/SA 3H 60-180V	153	19819	DESIGN FLAG SX SE/SA AT LF	117
18621	P.MODULA 500 IP42 SA/SE RM	33	19373	INV P&L LEDSESA3H 60-180V IP65	91	19820	DESIGN FLAG DX SE/SA AT LF	117
18630	P.MODULA 150 IP65 SE RM	33	19378	LUNGALARGA EX GL CT SE/SA LF	91	19821	DESIGN FLAG BASSO SE/SA AT LF	117
18631	P.MODULA 150 IP65 SA/SE RM	33	19396	LUNGALARGALUCE EX AT LF	147	19822	DESIGN FLAG ALTO SE/SA AT LF	117
18640	P.MODULA 300 IP65 SE RM	33	19398	INV UNIV AT RM 5W 20-240V	147	31000	DISPOS EVO 22M S230 WA/DA	141
18641	P.MODULA 300 IP65 SA/SE RM	33	19399	INV UNIV CT 5W 20-240V	147	31002	DISPOS EVO 30M S230 WA/DA	143
18650	P.MODULA 500 IP65 SE RM	33	19410	LOGICA LED LIFE LG SE	23	31024	QUADER 44M S230 DA	27
18651	P.MODULA 500 IP65 SA/SE RM	33	19411	LOGICA LED LIFE LG SA	55	31053	ACCIAIO LED SE/SA LGS230 GL	27
18660	P.MODULA 700 IP65 SE RM	33	19420	METRICA LED CT SA LF L	55	31054	ACCIAIO LED SE/SA LGS230	107
18661	P.MODULA 700 IP65 SA/SE RM	33	19421	METRICA LED CT SA LF XL	49	31056	TRIANGLE LG230	107
18670	P.MODULA 1000 IP65 SE RM	33	19430	F65 LED GL IP65 SE 1/1.5/3 LF	49	31057	TRIANGLE INOX LG230	57
18671	P.MODULA 1000 IP65 SA/SE RM	34	19431	F65 LED GL IP65 SA 1/1.5/3 LF	49	31090	LUMAX65 GR S230 G SA/SE 4K	57
18700	P.MODULA 300 IP65 AT SE RM	34	19432	F65 LED GL IP65 AT AR SE LF	49	31092	LUMAX65 GR HT EVG 4K	23
18701	P.MODULA 300 IP65 AT SA/SE RM	34	19433	F65 LED GL IP65 AT AR SA LF	49	31099	LOGICA 24W LED LGS230 LS-UV	139
18710	P.MODULA 500 IP65 AT SE RM	34	19434	F65 LED GL IP65 CT AR SE LF	49	31103	SIGNLED LG230	91
18711	P.MODULA 500 IP65 AT SA/SE RM	34	19435	F65 LED GL IP65 CT AR SA LF	37	31112	L.LARGA EXTREME LGS230 LS-UV	91
18721	P.MODULA 700 IP65 AT SA/SE RM	34	19450	INFINITA RTI CT SE LF L	37	31113	L.LARGA EXTREME HT	145
18731	P.MODULA 1000 IP65 AT SA/SE RM	34	19451	INFINITA RTI CT SE LF XL	37	31116	PIANALED 24M LG230 WA/DA	145
18740	P.MODULA 300 IP65 CT SE	34	19452	INFINITA RTI CT SA LF L	37	31117	PIANALED (30M) SICURO230 WA/DA	145
18741	P.MODULA 300 IP65 CT SA/SE	34	19453	INFINITA RTI CT SA LF XL	37	31118	PIANALED 24M S230 SP	145
18750	P.MODULA 500 IP65 CT SE	34	19454	INF RTI CT SE LF XL 700LM	37	31119	PIANALED 30M S230 SP	23
18751	P.MODULA 500 IP65 CT SA/SE	34	19455	INF RTI CT SA LF XL 700LM	37	31120	LOGICA LED LGS230 GL LS-UV	55
18761	P.MODULA 700 IP65 CT SA/SE	34	19460	INFINITA GL RTI CT SA LF	45	31121	METRICA LED LGS230 L LS-UV	50
18771	P.MODULA 1000 IP65 CT SA/SE	34	19461	INFINITA GL 5X CT SA LF	37	31122	F65 LED LGS230 GL LS-UV	55
18781	P.MODULA 2000 IP65 CT SA/SE	30	19470	INFINITA ULTIM RTI CT SE/SA LF	45	31123	METRICA LED LGS230 XL LS-UV	50
18821	MATRIX 1000 IP65 CT SA/SE	30	19471	INFINITA ULTIMATE 5X SE/SA LF	109	31124	F65 LED 8W LGS230	50
18831	MATRIX 2000 IP65 CT SA/SE	30	19600	NU.DA AE SE 1/1.5/3 TR LF	109	31125	F65 LED 11W LGS230	23
18841	MATRIX 2700 IP65 CT SA/SE	49	19601	NU.DA AE SE 1.5/3 TR LF	109	31140	LOGICA 8W LED LGS230 LS-UV	23
19290	F65LED 24W IP65 CT SE LF	49	19602	NU.DA AE SE/SA 1/1.5/3 TR LF	109	31141	LOGICA 11W LED LGS230 LS-UV	50
19291	F65LED 24WGL IP65 CT SE LF	49	19603	NU.DA AE SE/SA 1.5/3 TR LF	109	31150	F65 LED 24W LGS230	37
19292	F65LED 36W IP65 CT SE LF	49	19620	NU.DA 1124 AE CT SE LTO	109	31170	INFINITA RTI LG230 SE/SA L	37
19293	F65LED 36WGL IP65 CT SE LF	49	19621	NU.DA 2436 AE CT SE LTO	109	31171	INFINITA RTI LG230 SE/SA XL	45
19294	F65LED 24W IP65 CT SA LF	49	19622	NU.DA 1124 AE CT SE/SA LTO	109	31172	INFINITA 5X LG230 SE/SA XL	37
19295	F65LED 36W IP65 CT SA LF	49	19623	NU.DA 2436 AE CT SE/SA LTO	114	31174	INFINITA RTI HT L	37
19296	F65LED 36WGL IP65 CT SA LF	95	19700	DOT AE SE/SA 1/2/3H IP65 RM	114	31175	INFINITA RTI HT XL	45
19320	L.LARG DWCL HT 24W	95	19711	DOT AE CT SE/SA LF IP65	114	31176	INFINITA 5X HT XL	57
19328	L.LARG DWCL CT 24W SA LF	95	19712	DOT AE GL CT SE/SA IP65 LF	129	31208	LUMAX65 GR S230 G SA/SE 4K MW	57

Indice analitico

APPARECCHI / LUMINAIRES

Cod.	Descrizione	Pag.	Cod.	Descrizione	Pag.	Cod.	Descrizione	Pag.
31210	LUMAX65 GR HT EVG 4K MW	103	32058	TRIANGLE INOX LG24	57	19210N	F65 LED 36W IP65 SE 1/3 LF	49
31218	MULTI LENS LGS230	103	32067	LUMAX65 GR S24 SA/SE 4K	139	19212N	F65 LED 36W IP65 SA 1/3 LF	49
31219	MULTI LENS HT	27	32074	SIGNLED LG24	91	19355L	INV LED AT/LG AR 9W 55V LIFE	150
31300	ACCIAIO LED LG EPS DALI GL	37	32083	L.LARGA EXTREME LGS24 LS-UV	145	19391	INV EXT AT/LG AR 15W 55V LIFE	150
31301	INFINITA RTI LG EPS DALI L	45	32085	PIANALED 24M LG24 WA/DA	145	19430UV	F65 LED LTO SE UVOXY	53
31302	INFINITA X5 LG EPS DALI XL	50	32086	PIANALED (30M) SICURO 24 WA/DA	145	19431UV	F65 LED LTO SA UVOXY	53
31303	F65 8W LED LG EPS DALI	50	32087	PIANALED 24M LG24 SP	145	19432UV	F65 LED LTO AT SE UVOXY	53
31304	F65 24W LED LG EPS DALI	50	32088	PIANALED 30M LG24 SP	23	19433UV	F65 LED LTO AT SA UVOXY	53
31305	F65 36W LED LG EPS DALI	95	32089	LOGICA LED 36W LGS24 LS-UV	55	19450UV	INFIN RTI SE CT LTO L UVOXY	41
31306	L.LARG DWCL LG EPS DALI	99	32090	METRICA LED LGS24 L LS-UV	50	19451UV	INFIN RTI SE CT LTO XL UVOXY	41
31307	L.LARGA DWRC LG EPS DALI	91	32091	F65 LED 8W LGS24 SA LS-UV	27	19452UV	INFIN RTI SA CT LTO L UVOXY	41
31308	LLL EXTREME LG EPS DALI IP65	114	32092	ACCIAIO LED SE LGS24 GL	55	19453UV	INFIN RTI SA CT LTO XL UVOXY	41
31309	DOT AE LG EPS DALI	107	32093	METRICA LED LGS24 XL LS-UV	50	19460UV	INF RTI SA CT LTO GL UVOXY	41
31312	TRIANGLE LG EPS DALI	107	32094	F65 LED 8W SE LGS24	23	19628	NU.DA 1124 AE AT SE LF	109
31313	TRIANGLE INOX LG EPS DALI	107	32096	LOGICA LED 8W LGS24 LS-UV	37	19629	NU.DA 2436 AE AT SE LF	109
31314	TRIANGLE HT	107	32110	INFINITA RTI LGS24 L	37	19630	NU.DA 1124 AE AT SE/SA LF	109
31315	TRIANGLE INOX HT	139	32111	INFINITA RTI LGS24 SE/SA XL	45	19631	NU.DA 2436 AE AT SE/SA LF	109
31316	SIGNLED LG EPS DALI	139	32112	INFINITA 5X LGS24 SE/SA XL	50	19814	IRONFLAG AT 20M SA LF	129
31317	SIGNLED HT	129	32115	F65 LED LGS24 GL LS-UV	57	19815	IRONFLAG AT 30M SA LF	129
31318	IRONFLAG LG EPS DALI 20M	129	32122	LUMAX65 GR S24 SA/SE 4K MW	103	19816	IRONFL PEND AT 20M SA LF	129
31319	IRONFLAG LG EPS DALI 30M	129	32127	MULTI LENS LGS24 LS-UV	141	19817	IRONFL PEND AT 30M SA LF	129
31320	IRONFLAG PEND LG EPS DALI 20M	129	37000	DISPOS EVO 22M CT WA/DA	141	250ATSA	PRATICA IP65 300L SA AT	71
31321	IRONFLAG PEND LG EPS DALI 30M	127	37006	DISPOS EVO 30M CT WA/DA	143	250ATSAUV	PRATICA 300L SA AT UVOXY	75
31322	IRON FLAG IP65 LG EPS DALI	133	37072	QUADER 44M CT	57	250ATSE	PRATICA IP65 300L SE AT	71
31323	EXIT LG EPS DALI 20M	133	37126	LUMAX65 GR SA/SE CT 4K	145	250ATSEUV	PRATICA 300L SE AT UVOXY	75
31324	EXIT LG EPS DALI 30M	133	37168	PIANALED 24M CT WA/DA	145	250SA	PRATICA IP65 300L 1.5/3 SA TR	71
31325	EXIT LG EPS DALI 60M	143	37171	PIANALED 30M CT WA/DA	145	250SAUV	PRATICA 300L 1.5/3h SATR UVOXY	75
31326	QUADER 44M LG EPS DALI	143	37174	PIANALED 24M CT SP	145	250SE	PRATICA IP65 300L 1.5/3 SE TR	71
31327	QUADER 44M HT	145	37177	PIANALED 30M CT SP	139	250SEUV	PRATICA 300L 1.5/3h SETR UVOXY	75
31328	PIANALED 24M LG EPS DALI W/C	145	37225	SIGNLED 26M CT	57	4101N	COMPLETA LED 8W SE 1/3 LF	63
31329	PIANALED 30M LG EPS DALI W/C	145	37236	LUMAX65 GR SA/SE CT 4K MW	107	4102N	COMPLETA LED 11W SE 1/3 LF	63
31330	PIANALED 24M LG EPS DALI SP	145	37270	TRIANGLE CT	107	4103N	COMPLETA LED 24W SE 1/3 LF	63
31331	PIANALED 30M LG EPS DALI SP	145	37273	TRIANGLE INOX AT	125	4105N	COMPLETA LED 24W SA 1/3 LF	63
31332	PIANALED 24M HT W/C	145	81143	PLACCA BRAIN CLASSIC EM 3F BI	125	4108N	COMPLETA LED 36W SE 1/3 LF	63
31333	PIANALED 30M HT W/C	145	12185FM	LOG LED LGFM 8WSA 2/4/6N 750LM	23	4110N	COMPLETA LED 36W SA 1/3 LF	63
31334	PIANALED 24M HT SP	145	12186FM	LOGLED LGFM11WSA1.5/3/4N 900LM	23	4290A	DESIGN AE 8W SE 1H IP40	111
31335	PIANALED 30M HT SP	141	12187FM	LOG LED LGFM24WSA1/2/3N 1100LM	23	4291A	DESIGN AE 11W SE 1H IP40	111
31336	DISPOSEVO 22M LG EPS DALI W/D	141	1499/24	STILE IN LED 24W SE 4 LF	87	4292A	DESIGN AE 11W SE/SA 1H IP40	111
31337	DISPOSEVO 30M LG AC DALI W/D	141	1499BLU	STILE IN BLU SE 6/18H LF	87	4293A	DESIGN AE 24W SE 1H IP40	111
31338	DISPOSEVO 22M HT W/D	141	1499L	STILE IN LED 11W SE 3/6H LF	87	4372BA	UPLED BAND IP65 CT SA LTO	137
31339	DISPOSEVO 30M HT W/D	141	1499LUV	STILE IN LED SETR UVOXY	89	4376BA	UPLED BAND IP65 AT SA LF	137
32000	DISPOS EVO 22M S24, WA/DA	141	19200N	F65 LED 8W IP65 SE 1/3 LF	49	4385	EXIT DF20M AT SA LF	133
32002	DISPOS EVO 30M S24 WA/DA	143	19202N	F65 LED 11W IP65 SE 1/3 LF	49	4386	EXIT DF30M AT SA LF	133
32024	QUADER 44M S24 DA	27	19204N	F65 LED 11W IP65 SA 1/3 LF	49	4387	EXIT DF60M AT SA LF	133
32055	ACCIAIO LED SE/SA LGS24	107	19206N	F65 LED 24W IP65 SE 1/3 LF	49	4394	MULTI LENS GL AT SA LF	103
32057	TRIANGLE LG24	107	19208N	F65 LED 24W IP65 SA 1/3 LF	49	4395	MULTI LENS AT SE LF	103

Analytical index

APPARECCHI / LUMINAIRES

Cod.	Descrizione	Pag.
4396	MULTI LENS AT SA LF	103
4601	FRUTTOLUCE1 LED SE/SA 1N	121
4612	EM506 LED SE1H	123
500ATSA	PRATICA IP65 500L SA AT	71
500ATSAUV	PRATICA 500L SA AT UVOXY	75
500ATSE	PRATICA IP65 500L SE AT	71
500ATSEUV	PRATICA 500L SE AT UVOXY	75
500SA	PRATICA IP65 500L 1.5/3 SA TR	71
500SAUV	PRATICA 500L 1.5/3h SATR UVOXY	75
500SE	PRATICA IP65 500L 1.5/3 SE TR	71
500SEUV	PRATICA 500L 1.5/3h SETR UVOXY	75
824BA	UPLD BAND 824BA SA IP65 1.5LF	137
824L	UP LED 824L SE TR 1.5 LF	67
824LSA	UP LED 824L SA TR 1.5 LF	67
824M	UP LED 824M SE TR 1.5 LF	67
824MSA	UP LED 824M SA TR 1.5 LF	67
824S	UP LED 824S SE TR 3 LF	67
824XLSA	UP LED 824XL SA TR 1 LF	67
8595	T5 TUTTOLED IP65 18 SE 3/6LF	85
8596	T5 TUTTOLED IP65 18 SA 5LF	85
R0818	F65 LED 8W IP65 AT SE LF	49
R1124	F65 LED 24W IP65 AT SE LF	49
R1124SA	F65 LED 24W IP65 AT SA LF	49
R2436	F65 LED 36W IP65 AT SE LF	49
R2436SA	F65 LED 36W IP65 AT SA LF	49

ACESSORI / ACCESSORIES

Cod.	Descrizione	Pag.
2730	INIBIT 973 COMANDO R.MODE	50,68,72,75,78,82,85,104,109,114,117,127,130,134,137
2751	KIT INST CONTROSOFFITTO	72,78
3723	GANCIO SOSPENSIONE 4004/PR	31,35,38,42,46,72,75,78
3733	INCASSO STILE 6/11W 3106/IP	60,89,111
3893	ADES SX/DX/BS/UP PRAT IP42	77
3905	GRIGLIA ILLUM 685X182X110	27,82
3912	GRIGLIA EM 440X215X99	24,38,46,50,60,72,75,78,87,89
4117	ADES SX/DX/BS/UP PRAT IP65	75
4124	SCHERMO BAND ECOMP LED SX/DX	72,75
4125	SCHERMO BAND ECOMP LED BS	72,75
4126	SCHERMO BAND ECOMP LED UP	72,75
4127	SCHERMO BAND PRATICA SX/DX	35,78
4128	SCHERMO BAND PRATICA BS	35,78
4129	SCHERMO BAND PRATICA UP	35,78
4264	STAFFA C.SOFFITTO STILEIN ALTA	87
4265	STAFFA PARETE X BAND DES/COMP	87
4266	STAFFA CONTROSOFFITTO DES/COMP	60,111
4269	SCHERMI DX/SX/BS DES/COMP LED	60,87,89,111,127
4278	ADES SX/DX/BS/UP COMP LED	60,87,89,111
4312	ACCESS INC CONT UPLED EXIT 20M	134
4313	ACCESS INC CONT UPLED EXIT 30M	134
4315	SOSPEN TIGES L250	38,42,46,134
4316	SOSPEN TIGES L500	38,42,46,134
4317	SOSPEN TIGES L1000	38,42,46,134
4318	ACCESSORIO IP65 UP LED 824	60,68
4319	KIT BINARIO TRIFASE UP LED	31,35,68,109,134,137
4325	SCHERMO BAND UPLED DX SX BS UP	68
4326	SCHERMO UPLED DX SX BS UP	68
4665	ADES UP IRON/EXIT 30M	127,13
4681	SCHERMO BAND INFINITA 25MT	38,42
4682	ADES SX/DX/BS/UP INFINITA	41
4683	SCATOLA INCASSO INFINITA	38,46
4687	STAFFA IN CARTONGESSO INFINITA	38,46
11582	ADES USCITA TICINQUE LED	82
11585	ADES BS TICINQUE LED	82
11595	ADES FREC IN BASSO TICINQUE 18	85
12101	TELECOMANDO LOGICA INIBIT RM	24
12175	SCHERMO LOGICA LED DX	24
12176	SCHERMO LOGICA LED SX	24
12177	SCHERMO LOGICA LED BS	24
12178	SCHERMO LOGICA LED UP	24
12179	SCAT INCASSO CORN BI LOGICALED	24
12180	STAFFA CONTROSOFFITTO BI LOGICA LED	24
12199	STAFFA PARETE LOGICA IP65	24
12942	INCASSO/CORNICE	55

Indice analitico

ACCESSORI / ACCESSORIES

Cod.	Descrizione	Pag.
12943	INCASSO/CORNICE 8/18/24W	55
14771	SOSPENSIONE MONO/BI LAMPADA	134
15030	ACC EM LED 24 CT SA LF	27
15032	ACC EM LED GL CT SE	27
15036	MODULO LG	27, 38, 42,46,50, 55,57,68,85,92,96,100,104,109,114,117,126,130,134,137
15037	MODULO LGFM	24,27,38,42,46,50,55,57,68,96,100,104,109,114,134,137,147
15038	MODULO DALI	24,38,42,46,50,55,57,68,92,96,100,104,109,114,117,127,130,134
15043	STAFFA ORIENTABILE LLL EX	92
15044	STAFFA INCASSO LLL EX	92
15048	MODULO RM PLUG	51,60,68,72,78,82,85,87,109,127,137
15049	MODULO RADIO LGFM IP65	92,125,127,130
15056	LG MODULA	31,35
15057	FM MODULA	31,35
15058	DALI MODULA	31,35
15059	MODULO LG24	31,35
15060	MODULO LG230	31,35
15061	MODULO LG EPS DALI	31,35
15078	ICE PACK MODULA	35
15079	MODULO LG SLIM	27,114,147
15080	MODULO DALI SLIM	27,147
18580	SCAT INCASSO+CORN P.MODULA	31,35
18581	SCHERMO BAND SX/DX P.MODULA	35
18582	SCHERMO BAND BASSO P.MODULA	35
18583	SCHERMO BAND ALTO P.MODULA	35
18584	ADES SX/DX/BS/UP P.MODULA	34,35
18585	STAFFA PARETE BAND P.MODULA	35,38,42
18586	STAFFA CONTROS+CORNICE	31,35
18587	STAFFA BLINDOLUCE P.MODULA	31,35
18589	STAFFA DERIVAZIONE EASY BOX	31,34,35
18590	STAFFA 45° P.MODULA	31,35,38,42,46
18591	GRIGLIA EM 305X135X80	31,35,68,109
18592	KIT IP65 TUBO BOX BASSO P.MOD	31,35
18593	SCHERMO SX P.MODULA	35
18594	SCHERMO DX P.MODULA	35
18595	SCHERMO BASSO P.MODULA	35
18596	SCHERMO ALTO P.MODULA	35
18597	TEGOLINO PRO PIOGGIA INOX	31,35
18598	CORNICE ESTETICA	31,34,35
18599	ADATT INCASSO PRATICA IP65	31,35
19040	INCASSO + CORNICI F65	50
19041	STAFFA CONTROSOFFITTO F65	50
19042	SCHERMO BANDIERA DX/SX F65	51,53
19043	SCHERMO BANDIERA BASSO F65	51,53

Cod.	Descrizione	Pag.
19044	ADES SX DX BS F65	53
19045	STAFFA A PARETE X BANDIERA F65	51,53,134
19048	SCAT INCASSO + CORNICE F65 EX	50
19049	STAFFA CONTROSOFFITTO F65 EX	50
19064	SCHERMO BAND DX/SX/BS ACC EM	27
19375	MODULO LGFM INVERTER LED	150
19376	GUSCIO IP65 INVERTER LED	150
19880	INCASSO 20M	130
19881	INCASSO 30M	130
19885	INCASSO IRON PEND 20m	130
19886	INCASSO IRON PEND 30m	130
20122	STAFFA ORIENTABILE ACC E LED	27
20151	CENTRALE CABLECOM CONNECT	42
20155	PASSANTE INFINITA 5P	38,46
20157	MODULO ROUTER 4G	155,157
26723	CARTUCCIA EMERGENZA UVOXY	42,53,75
26724	CARTUCCIA STILE IN UVOXY	89
81236	KIT ADATTATORE 3FR BIANCO	125
81237	KIT ADATTATORE 3FR NERO	125
RA11	BOOSTER AR M LiFe 3.2V 1,5Ah	35
11583	ADES SX TICINQUE LED	82
11584	ADES DX TICINQUE LED	82
11593	ADES USCITA A SN TICINQUE 18	85
11594	ADES USCITA A DS TICINQUE 18	85
12131C	CENTRALE SUPERVISIONE	157
12941	AD METRICA DX/SX/BAS EU XL	55
12944	AD METRICA DX/SX/BS/UP L	55
19887	LENTE DOT ASIMMET ALTALUCE	113
2741	INC COMPL 6-11 3974/IP	77
2742	INC COMPL ST 6/11 4974/IP	72
3727	GR PRESSATU 16/20-4003/RG	55,78,85
4117	ADES SX/DX/BS/UP PRAT IP65	71,72
4264	STAFFA C.SOFFITTO STILEIN ALTA	89
4265	STAFFA PARETE X BAND DES/COMP	111
4267	SCHERMO BAND DXSX DES/COMP LED	87
4268	SCHERMO BAND BASS DES/COMP LED	87,111
81296E	BATTERIA LT PLACCA B.CLASSIC	125
E16029M	SCREEN KIT 45° PIANALED 24M	145
E16030M	SCREEN KIT 45° PIANALED 30M	145
E16031M	PITTOGRAMMA PIANALED ALTO 24M	145
E16032M	PITTOGRAMMA PIANALED ALTO 30M	145
E16128M	SCHERMO BASSO DISPOS	141
E16129M	SCHERMO DESTRA DISPOS	141
E16132M	PITTOGRAMMA 30M ALTO	141
E16260M	PITTOGRAMMA 22M BASSO	141
E16261M	PITTOGRAMMA 22M DX SX	141

Analytical index

ACCESSORI / ACCESSORIES

Cod.	Descrizione	Pag.
E16263M	PITTOGRAMMA 22M ALTO	141
E16910M	PRONTO SOCCORSO	139
E16911M	PUNTO DI RACCOLTA	139
E16912M	TELEFONO EMERGENZA	139
E16913M	PULSANTE EMERGENZA	139
E16914M	ESTINTORE	139
E16915M	MANICHETTA	139
F15325M	QUADER 44M BS	143
F15326M	QUADER 44M DX	143
F15327M	QUADER 44M SX	143
F15328M	QUADER 44M AL	143
F15329M	QUADER 22M AL	143
F15330M	QUADER 22M BS	143
F15331M	QUADER 22M DX	143
F15332M	QUADER 22M SX	143
F94001	ADATTATORE INCASSO PIANALED 30	145
F94002	ADATTATORE INCASSO PIANALED 24	145
F95406	ADATTATORE PER SOSP. CAVO	143
F95807	LENTE LUNGALUCE 12M	96, 100
F95808	LENTE LARGALUCE 12M	96, 100
F95815	LENTE ASIMMETRIC LLL/PLURALUCE	96, 100
F95819	LENTE LARGALUCE 7M	96, 100
F95947	ADATTATORE INCASSO WHITE 22M	141
F95948	ADATTATORE INCASSO WHITE 30M	141
F95949	STAFFA FISSAGGIO BANDIERA 22M	141
F95950	STAFFA FISSAGGIO BANDIERA 30M	141
RA06	SISTEMA BAT AR LI-FE 9.6V1.5AH	50,82,150
RA08	SISTEMA BAT AR LIFE 12.8V1.5AH	150
RA10	BOOSTER AR S LiFe 3.2V 0,5Ah	35
RA13	BOOSTER BAT LiFe 6.4V 1.5Ah	147

SISTEMI DI CONTROLLO / CONTROL SYSTEM

Cod.	Descrizione	Pag.
2730	INIBIT 973 COMANDO R.MODE	163
12101	TELECOMANDO LOGICA INIBIT RM	163
12134	CONVERTITORE DIN RS232/RS485	209,216
12136	CONVERTITORE RS485 USB	181
15036	MODULO LG	159
15037	MODULO LGFM	159
15038	MODULO DALI	159
15049	MODULO RADIO LGFM IP65	159
16322	CENTRALE LG EPS LOG	208,215
16323	MODULO RS485 LG EPS ECO	209
16324	MODULO LAMPADA TW 500	210,217
17063	LGS24 4U 56AH G	191
17064	LGS24 SOTTOCENTRALE B	176
17207	PANNELLO REMOTO SLG A PARETE	182,196
17208	PANNELLO REMOTO SLG A INCASSO	182,196
17230	MODULO INGRESSO SLGS 230V DIN	178,194
17231	MODULO INGRESSO SLGS 24V DIN	178,194
17232	MODULO DI USCITA S230 2X32	180
17233	MODULO DI USCITA S230 1X32	180
17234	MODULO DI USCITA S230 4X32	180
17237	MODULO LS-UV LOGICA 230	182
17240	CBS REMOTE PANEL 7" WHITE SLGS	182,195
17384	KIT BATTERY MONITOR	182
17385	DS3-UV 1-3 PHASE MONITORING	181,197, 211, 216
17386	SWITCH LG EPS 500W	210,217
17602	CENTRALE ST5 S230 7.2AH 2P	170
17613	CENTRALE STX5 S230 20AH 1P	171
17615	CENTRALE STX5 S230 20AH 3P	171
17617	CENTRALE STX5 S230 28AH 2P	171
17650	CENTRALE ST24 S230 70AH 1P	175
17651	CENTRALE ST24 S230 70AH 2P	175
17652	CENTRALE ST24 S230 70AH 3P	175
17653	CENTRALE ST24 S230 90AH 1P	175
17654	CENTRALE ST24 S230 90AH 2P	175
17655	CENTRALE ST24 S230 90AH 3P	175
17656	CENTRALE ST24 S230 100AH 1P	175
17657	CENTRALE ST24 S230 100AH 2P	175
17658	CENTRALE ST24 S230 100AH 3P	175
17662	CENTRALE ST24 S230 120AH 1P	175
17663	CENTRALE ST24 S230 120AH 2P	175
17664	CENTRALE ST24 S230 120AH 3P	175
17668	CENTRALE ST24 S230 150AH 1P	175
17669	CENTRALE ST24 S230 150AH 2P	175
17670	CENTRALE ST24 S230 150AH 3P	175
17671	CENTRALE ST24 S230 200AH 1P	175
17672	CENTRALE ST24 S230 200AH 2P	175

Indice analitico

SISTEMI DI CONTROLLO / CONTROL SYSTEM

Cod.	Descrizione	Pag.	Cod.	Descrizione	Pag.
17673	CENTRALE ST24 S230 200AH 3P	175	17620	CENTRALE ST13 S230 20AH 1P	173
17674	CENTRALE ST24 S230 250AH 1P	175	17621	CENTRALE ST13 S230 20AH 2P	173
17675	CENTRALE ST24 S230 250AH 2P	175	17622	CENTRALE ST13 S230 20AH 3P	173
17676	CENTRALE ST24 S230 250AH 3P	175	17623	CENTRALE ST13 S230 28AH 1P	173
17680	SOTTOCENTRALE ST8 S230	176	17624	CENTRALE ST13 S230 28AH 2P	173
17681	SOTTOCENTRALE ST16 S230	176	17625	CENTRALE ST13 S230 28AH 3P	173
17682	SOTTOCENTRALE ST32 S230	176	17626	CENTRALE ST13 S230 33AH 1P	173
17685	MOD DI USCITA EXT S230 2X32	177	17627	CENTRALE ST13 S230 33AH 2P	173
17686	MOD DI USCITA EXT S230 2+2X32	177	17628	CENTRALE ST13 S230 33AH 3P	173
20151	CENTRALE CABLECOM CONNECT	155	17629	CENTRALE ST13 S230 45AH 1P	173
21102	CENTRALE DOMOTICA SD-LGFM	159	17630	CENTRALE ST13 S230 45AH 2P	173
30166	ESM 25 KVA 1-PHASE	218	17631	CENTRALE ST13 S230 45AH 3P	173
30167	ESM 25 KVA 3-PHASE	218	17632	CENTRALE ST13 S230 55AH 1P	173
30168	ESM 50 KVA 3-PHASE	218	17633	CENTRALE ST13 S230 55AH 2P	173
30169	ESM 100 KVA 3-PHASE	218	17634	CENTRALE ST13 S230 55AH 3P	173
30170	SCHEDA RETE LAN TCP/IP LG EPS	215	17635	CENTRALE ST13 S230 70AH 1P	173
34006	KUBUS DYNAMIC S24 WA	201	17636	CENTRALE ST13 S230 70AH 2P	173
34007	KUBUS DYNAMIC S24 DA	201	17637	CENTRALE ST13 S230 70AH 3P	173
12100C	CENTRALE CONNECT LG	157	17638	CENTRALE ST13 S230 90AH 1P	173
12131C	CENTRALE SUPERVISIONE	161	17639	CENTRALE ST13 S230 90AH 2P	173
17060	LGS24 4U 12AH B	190	17640	CENTRALE ST13 S230 90AH 3P	173
17061	LGS24 4U 24AH B	190	17641	CENTRALE ST13 S230 100AH 1P	173
17062	LGS24 4U 28AH G	191	17642	CENTRALE ST13 S230 100AH 2P	173
17065	LGS24 8U 28AH G	191	17643	CENTRALE ST13 S230 100AH 3P	173
17066	LGS24 8U 56AH G	191	17700K	EPS ECO SE/SA 1KVA 1P 1ELM	208
17075	LGS24 4U EXTREME 20AH	192	17701K	EPS ECO SE/SA 1KVA 2P 1ELM	208
17076	LGS24 4U EXTREME 40AH	192	17702K	EPS ECO SE/SA 1KVA 3P 1ELM	208
17077	LGS24 8U EXTREME 20AH	193	17703K	EPS ECO SE/SA 2KVA 1P 1ELM	208
17078	LGS24 8U EXTREME 40AH	193	17704K	EPS ECO SE/SA 2KVA 2P 1ELM	208
17210	INV LED IP65 SLGS SICURO 24V	195	17705K	EPS ECO SE/SA 2KVA 3P 1ELM	208
17220	INV LED SLGS SICURO 24V	195	17706K	EPS ECO SE/SA 3KVA 1P 1ELM	208
17236	DRM MODULE	177	17707K	EPS ECO SE/SA 3KVA 2P 1ELM	208
17381	INVERTER LG230 12W	179	17708K	EPS ECO SE/SA 3KVA 3P 1ELM	208
17382	INVERTER LG230 12W	179	17709K	EPS ECO SE/SA 4KVA 1P 1ELM	208
17383	SWITCH SICURO 230V DALI	180	17710K	EPS ECO SE/SA 4KVA 2P 1ELM	208
17601	CENTRALE ST5 S230 7.2AH 1P	170	17711K	EPS ECO SE/SA 4KVA 3P 1ELM	208
17603	CENTRALE ST5 S230 7.2AH 3P	170	17712K	EPS ECO SE/SA 6KVA 1P 1ELM	208
17604	CENTRALE ST5 S230 12AH 1P	170	17713K	EPS ECO SE/SA 6KVA 2P 1ELM	208
17605	CENTRALE ST5 S230 12AH 2P	170	17714K	EPS ECO SE/SA 6KVA 3P 2ELM	208
17606	CENTRALE ST5 S230 12AH 3P	170	17715K	EPS ECO SE/SA 8KVA 1P 1ELM	208
17610	CENTRALE STX5 S230 12AH 1P	171	17716K	EPS ECO SE/SA 8KVA 2P 1ELM	208
17611	CENTRALE STX5 S230 12AH 2P	171	17717K	EPS ECO SE/SA 8KVA 3P 2ELM	208
17612	CENTRALE STX5 S230 12AH 3P	171	17718K	EPS ECO SE/SA 10KVA 1P 1ELM	208
17614	CENTRALE STX5 S230 20AH 2P	171	17719K	EPS ECO SE/SA 10KVA 2P 2ELM	208
17616	CENTRALE STX5 S230 28AH 1P	171	17720K	EPS ECO SE/SA 10KVA 3P 2ELM	208
17618	CENTRALE STX5 S230 28AH 3P	171	17375	MODULO LGFM INVERTER LED	159

Analytical index

SISTEMI DI CONTROLLO / CONTROL SYSTEM

Cod.	Descrizione	Pag.
30150K1-2	EPS PRO 2KVA 1M 1H	214
30150K1-3	EPS PRO 3KVA 1M 1H	214
30150K2-2	EPS PRO 2KVA 1M 2H	214
30150K2-3	EPS PRO 3KVA 1M 2H	214
30150K3-2	EPS PRO 2KVA 1M 3H	214
30150K3-3	EPS PRO 3KVA 1M 3H	214
30151K1	EPS PRO 5KVA 1M 1H	214
30151K2	EPS PRO 5KVA 1M 2H	214
30152K1	EPS PRO 6KVA 1M 3T 1H	214
30152K2	EPS PRO 6KVA 1M 3T 2H	214
30152K3	EPS PRO 6KVA 1M 3T 3H	214
30153K1	EPS PRO 8KVA 1M 3T 1H	214
30153K2	EPS PRO 8KVA 1M 3T 2H	214
30153K3	EPS PRO 8KVA 1M 3T 3H	214
30154K1	EPS PRO 10KVA 1M 3T 1H	214
30154K2	EPS PRO 10KVA 1M 3T 2H	214
30154K3	EPS PRO 10KVA 1M 3T 3H	214
30155K1	EPS PRO 12KVA 1M 3T 1H	214
30155K2	EPS PRO 12KVA 1M 3T 2H	214
30155K3	EPS PRO 12KVA 1M 3T 3H	214
30156K1	EPS PRO 15KVA 1M 3T 1H	214
30156K2	EPS PRO 15KVA 1M 3T 2H	214
30156K3	EPS PRO 15KVA 1M 3T 3H	214
30157K1	EPS PRO 20KVA 1M 3T 1H	214
30157K2	EPS PRO 20KVA 1M 3T 2H	214
30157K3	EPS PRO 20KVA 1M 3T 3H	214
30158K1	EPS PRO 10KVA 3T 1H	214
30158K2	EPS PRO 10KVA 3T 2H	214
30158K3	EPS PRO 10KVA 3T 3H	214
30159K1	EPS PRO 12KVA 3T 1H	214
30159K2	EPS PRO 12KVA 3T 2H	214
30159K3	EPS PRO 12KVA 3T 3H	214
30160K1	EPS PRO 15KVA 3T 1H	214
30160K2	EPS PRO 15KVA 3T 2H	214
30160K3	EPS PRO 15KVA 3T 3H	214
30161K1	EPS PRO 20KVA 3T 1H	214
30161K2	EPS PRO 20KVA 3T 2H	214
30161K3	EPS PRO 20KVA 3T 3H	214
30162K1	EPS PRO 25KVA 3T 1H	214
30162K2	EPS PRO 25KVA 3T 2H	214
30162K3	EPS PRO 25KVA 3T 3H	214
30163K1	EPS PRO 30KVA 3T 1H	214
30163K2	EPS PRO 30KVA 3T 2H	214
30163K3	EPS PRO 30KVA 3T 3H	214
30164K1	EPS PRO 35KVA 3T 1H	214
30164K2	EPS PRO 35KVA 3T 2H	214

Cod.	Descrizione	Pag.
30164K3	EPS PRO 35KVA 3T 3H	215
30165K1	EPS PRO 40KVA 3T 1H	215
30165K2	EPS PRO 40KVA 3T 2H	215
30165K3	EPS PRO 40KVA 3T 3H	215
34000	SEGUI LED LGS24 DYNAMIC	201
34002	SEGUILED STEP DYNAMIC S24	201
RA09	SISTEMA BAT AR LTO 4.8V 0.5AH	177

Condizioni generali di vendita

1. ORDINI - PERFEZIONAMENTO DEGLI ACCORDI

Gli ordini di acquisto dei prodotti devono essere formulati per iscritto. Il conferimento dell'ordine si intende irrevocabile. Tutti i programmi di collaborazione, gli ordini, le commissioni e gli accordi si intendono perfezionati, con la conferma scritta o verbale dalla Venditrice o, comunque, con l'inizio della fatturazione e/o della consegna dei prodotti ordinati.

2. VARIANTI E MODIFICHE

Dopo il perfezionamento dell'ordine ogni modifica o integrazione al contenuto ed alle condizioni dell'ordine sarà valida e diventerà efficace unicamente con la trasmissione da parte della Venditrice all'Acquirente di una variante della conferma. Il testo della conferma o della variante di conferma della Venditrice prevarrà in ogni caso su qualunque altro documento. L'Acquirente che non intendesse accettare le condizioni difformi rispetto al proprio ordine, dovrà rilevarlo entro 20 (venti) giorni dalla data di conferma, senza di che la variante di conferma si intenderà integralmente accettata.

3. MODALITÀ DI ACCETTAZIONE

Alla Venditrice non potrà essere addossata alcuna responsabilità per mancata accettazione di un ordine, ovvero per mancata o ritardata fornitura dei prodotti oggetto dello stesso. L'accettazione e l'esecuzione dell'ordine sono specificamente subordinate alla disponibilità dei prodotti ordinati nonché all'assenza di circostanze che possano comunque influire sulla reperibilità dei medesimi e sulla tempestività della consegna degli stessi.

4. TERMINI DI CONSEGNA

I termini di consegna comunicati dalla Venditrice hanno valore puramente indicativo. I termini di consegna espressi in giorni sono normalmente computati in giorni lavorativi. Le eventuali modifiche dei termini di consegna richieste dall'Acquirente dovranno essere accettate per iscritto dalla Venditrice. Gli eventuali ritardi in consegna, così come le interruzioni e/o le sospensioni totali o parziali delle forniture, anche se non dovute a cause di forza maggiore e/o caso fortuito, non daranno diritto al risarcimento di danni e/o indennizzi di qualsiasi genere e neppure ad interessi, salva la sola facoltà per l'Acquirente di annullare l'ordine, previa messa in mora della Venditrice di almeno trenta giorni decorrenti dal giorno di ricevimento della raccomandata A.R. inviata dall'Acquirente.

5. FORZA MAGGIORE

A titolo meramente indicativo ed esemplificativo, ma non tassativo, sono considerati casi di forza maggiore: scioperi, serrate, tumulti, conflitti di lavoro, guerre, incendi, calamità naturali, impossibilità di approvvigionamento dei prodotti, interruzioni o difficoltà dei trasporti ritardi di spedizione, mancanza di materie prime, attacchi informatici e hacking, atti governativi, provvedimenti di autorità, eventuali inadempimenti di fornitori e, in genere, ogni evento imprevedibile che sia al di fuori della ragionevole possibilità di controllo da parte della Venditrice. In tutti tali casi, così come nell'ipotesi di caso fortuito, la Venditrice si riserva la facoltà di sospendere e/o ritardare la consegna dei prodotti ed anche di annullare gli ordini, anche se già confermati, senza che ciò possa dar diritto all'Acquirente di richiedere alla Venditrice il risarcimento di danni e/o indennizzi di qualsiasi tipo, ivi inclusi quelli diretti, indiretti e consequenziali.

6. CONSEGNA - TRASPORTO

La merce viaggia sempre a rischio e pericolo dell'Acquirente, anche se spedita in porto franco e/o con automezzo della Venditrice, per cui la Venditrice non accetterà contestazioni per eventuali rotture e/o manomissioni dei prodotti. La consegna dei prodotti si intende effettuata presso la sede della Venditrice a Montevoglio - Valsamoggia (Bologna) o presso depositi terzi con i quali la Venditrice ha stipulato apposite convenzioni (condizione "Ex works" - Incoterms 2010). Le spese di trasporto sono a carico dell'Acquirente. La Venditrice non accetta imballi di ritorno.

7. RECLAMI - SOSTITUZIONE DEI PRODOTTI

Per sostituzioni e reclami si applicano le tutele previste dalla legislazione applicabile alla specifica tipologia di cliente, operatore professionale o consumatore. Non appena ricevuti i prodotti, l'Acquirente sarà tenuto a verificare lo stato, la quantità della fornitura e la sua rispondenza alla bolla di consegna. Eventuali reclami in merito alla qualità, quantità, tipo del prodotto, dovranno essere fatti per iscritto entro 8 (otto) giorni dalla data di ricevimento della merce. Decorso tale termine, fatte comunque salve le diverse condizioni di garanzia previste per i singoli prodotti, nessun reclamo potrà più essere avanzato sia per la sostanza e la qualità della merce, sia per le condizioni in genere della stessa. L'Acquirente non potrà per nessuna ragione restituire i prodotti senza la preventiva autorizzazione scritta della Venditrice né ritardare e/o sospendere totalmente o parzialmente il pagamento delle fatture, neppure nel caso di reclami. Qualora il reclamo risulti fondato a giudizio della Venditrice, e sia stato proposto entro i termini di garanzia riportati nei libretti illustrativi che accompagnano i singoli prodotti, l'obbligo di questa si limita alla semplice sostituzione del prodotto non conforme secondo le modalità di consegna della prima fornitura. Resta pertanto escluso qualunque diritto dell'Acquirente di annullare l'ordine o di ottenere qualsiasi risarcimento per spese e/o danni. Il diritto alla sostituzione del prodotto contestato

decade se il prodotto non viene conservato diligentemente, tenuto a disposizione della Venditrice, nonché immediatamente restituito nel luogo stabilito dalla Venditrice.

8. APPLICAZIONE DELLA GARANZIA

La garanzia si applica esclusivamente per vizi e/o difetti di conformità del prodotto in relazione ai termini e alle condizioni indicate nelle specifiche tecniche dichiarate e/o concordate o per rottura prematura di una delle sue parti. Il periodo di validità della suddetta garanzia è per un periodo minimo di 24 mesi decorrenti dalla data di acquisto dimostrabile attraverso la presentazione di un documento fiscalmente valido. Gli apparecchi che beneficiano di garanzie estese sono contrassegnati nei cataloghi o nei fogli istruzioni con il numero di anni di garanzia complessivi in abbinamento con la lettera G (es. contrassegno 5G per prodotti che beneficiano di 5 anni di garanzia). Di norma si applicano le seguenti estensioni: gli apparecchi di illuminazione di emergenza e i sistemi di illuminazione di emergenza centralizzata beneficiano di 5 anni di garanzia, quelli equipaggiati di batterie con nuova tecnologia al Litio, con denominazione TEN YEARS, beneficiano di 10 anni di garanzia (su tutte le parti, batterie comprese); apparecchi illuminazione EcoDriver - ED - o Regolabili - RD - beneficiano di 3 anni di garanzia, apparecchi illuminazione SmartDriver - SD - beneficiano di 5 anni di garanzia (su tutte le parti, sorgenti incluse). La garanzia non si applica in caso di manomissione, per difetti causati da danni accidentali di qualsiasi natura, anche durante il trasporto e l'installazione, per utilizzo improprio o non conforme alle specifiche di prodotto, per negligenza nell'uso e nella manutenzione, per errori di installazione o collegamento, in caso di installazione non eseguita da personale qualificato e comunque non realizzata a Regola d'Arte. Salvo diversa prescrizione di Legge applicabile, la garanzia si limita alla sola sostituzione/riparazione del prodotto o delle parti non conformi secondo le modalità di consegna della prima fornitura. L'intervento in garanzia da parte della Venditrice rimane subordinato alla osservanza delle condizioni di pagamento da parte dell'Acquirente.

9. PREZZI

I prezzi indicati nei listini della Venditrice non sono impegnativi, di conseguenza la Venditrice si riserva il diritto di modificarli fino al momento della consegna dei prodotti. I prezzi s'intendono al netto di IVA e di altri eventuali oneri fiscali.

10. PAGAMENTI

Tutti i pagamenti dovranno essere effettuati nei termini e nelle modalità indicate dalla Venditrice presso la sede della Venditrice in Montevoglio - Valsamoggia (Bologna). In caso di ritardo nel pagamento, l'acquirente inadempiente sarà tenuto a corrispondere alla Venditrice gli interessi di mora dalla scadenza del termine contrattuale fino al saldo, nella misura prevista dal D.lgs. 231/2002, salvo in ogni caso il risarcimento per i maggiori danni subiti. Il mancato rispetto dei termini di pagamento da parte dell'Acquirente darà la facoltà alla Venditrice di risolvere il relativo contratto di fornitura con effetto immediato e di sospendere la consegna di tutti i prodotti comunque ordinati senza necessità di comunicazione alcuna, con il conseguente diritto per la Venditrice di esigere l'immediato pagamento dell'intero credito nonché di agire per il risarcimento dei danni subiti. In caso di inadempimento, e/o di peggioramento delle condizioni patrimoniali che mettano in pericolo l'incasso del credito da parte della Venditrice, e/o di prolungato ritardo nei pagamenti e/o di elevata esposizione debitoria complessiva (anche per effetto di precedenti vendite non incassate) da parte dell'Acquirente, la Venditrice si riserva di applicare le disposizioni degli art. 1460 e 1461 CC, di intraprendere le opportune azioni cautelari e di ricorrere a qualsiasi altra forma di autotutela consentita; è ulteriormente convenuto che in tali casi la Venditrice può sospendere ogni e qualsiasi fornitura.

11. RISERVATO DOMINIO

I prodotti si intendono venduti con patto di riservato dominio; gli stessi pertanto resteranno di proprietà della Venditrice fino all'avvenuto saldo integrale del relativo prezzo. L'Acquirente si impegna quindi ad informare i terzi dell'esistenza ed efficacia del presente patto di riservato dominio, nonché a salvaguardare i diritti della Venditrice derivanti dal medesimo.

12. SALVAGUARDIA - CONTROVERSIE E FORO COMPETENTE

L'invalidità o l'inapplicabilità di una delle clausole contenute nelle presenti condizioni generali di vendita, non pregiudicherà, o sminuirà la validità ed applicabilità delle altre disposizioni; la Venditrice e l'Acquirente si impegnano fin d'ora a sostituire le clausole dichiarate inefficaci e/o nulle, ovvero impraticabili, con altra disposizione dagli effetti analoghi. Per qualsiasi controversia o contestazione relativa all'interpretazione, validità ed esecuzione dell'ordine o comunque connessa ai contratti cui si applicano le presenti condizioni generali di vendita sarà disciplinata dalla Legge Italiana. Foro competente, in via esclusiva, è il Foro di Bologna.

13. TRATTAMENTO DATI PERSONALI

I dati personali raccolti dalla Venditrice in sede d'ordine saranno trattati ai sensi del Reg. EU 2016/679 Regolamento Europeo in materia di protezione dei dati personali come da privacy policy presente sul sito www.beghelli.it

Sicurezza prodotti e direttive UE

SICUREZZA PRODOTTI E DIRETTIVE EUROPEE

I prodotti Beghelli sono costruiti a regola d'arte in materia di sicurezza e qualità e non compromettono anche nelle condizioni di sovraccarico prevedibili, la sicurezza delle persone, degli animali domestici e dei beni, se installati e utilizzati in conformità alla loro destinazione e nelle condizioni ambientali previste, montati in modo non difettoso e soggetti ad idonea manutenzione da parte di personale qualificato.

Per quanto applicabili, i prodotti sono costruiti in conformità ai requisiti di cui alle direttive comunitarie 2014/35/EU, 2014/30/EU, 2014/53/EU, 2014/30/EU, 2009/125/CE, 2001/65/CE.

La marcatura CE apposta sul prodotto e/o sull'imballaggio e/o sulle eventuali avvertenze d'uso che accompagnano il prodotto attesta la conformità alle Direttive di cui sopra. Beghelli conserva un proprio Archivio Tecnico, a disposizione delle autorità competenti per eventuali ispezioni, contenente la documentazione che dimostra che il prodotto è stato esaminato per valutarne la conformità.

I prodotti che non ricadono nel campo di applicazione delle Direttive CE sopra indicate sono conformi agli standard qualitativi previsti dalle normative vigenti e alla Direttiva 2001/95/CE ("Direttiva sicurezza Generale dei prodotti"), recepita con D.lgs. n. 172/2004.

I dati contenuti nel presente catalogo possono essere soggetti a variazione senza preavviso.

Le indicazioni, misure, disegni e foto dei prodotti e dei componenti sono riportate a titolo informativo e possono essere modificate senza preavviso, non essendo intese come informazioni precontrattuali. Tutti i prodotti per cui è prevista la connessione alla rete elettrica, devono essere installati secondo le norme impiantistiche in vigore nei paesi di destinazione e secondo le informazioni contenute nel Catalogo e/o sulle relative istruzioni allegate al prodotto stesso.

Difesa dell'ambiente

DIRETTIVA RAEE 2012/19/UE

Sono in rapido incremento le quantità di rifiuti riconducibili ad apparecchiature elettriche ed elettroniche (RAEE), tra queste sono state incluse anche gran parte delle sorgenti luminose.

La direttiva si propone come scopo principale quello di impedire che i RAEE a fine vita vengano gettati nelle discariche o negli inceneritori provocando un ulteriore grave impatto ambientale.

La direttiva 2012/19/UE ha dunque cercato di indurre un meccanismo di controllo che preveda una gestione controllata del dispositivo a fine vita privilegiando il suo reimpiego o il suo riciclaggio. Inoltre il meccanismo legislativo promuove concetti di progettazione e produzione che rendano più agevole lo smaltimento dei prodotti sia in termini di disassemblaggio che di materiali.

Tutti i passaggi della catena commerciale sono chiamati a dare un proprio contributo, chi in termini economici, chi in termini di attività affinché lo spirito della direttiva sia rispettato (e l'ambiente tutelato).

In Italia la direttiva è stata recepita con D. Lgs. n. 49 del 14 marzo 2014.

QUESTI I PRINCIPALI OBBLIGHI PREVISTI

Il produttore (inteso in senso ampio e dunque sostanzialmente chi appone il proprio marchio sul bene e chi importa da paese terzo) è responsabile dei costi di smaltimento dei propri prodotti giunti a fine vita.

Il consumatore è chiamato ad una gestione intelligente del bene a fine vita conferendolo

ad una piazzola attrezzata, ad un punto vendita o seguendo le indicazioni fornite dal costruttore.

Beghelli, da sempre sensibile alla problematica ambientale, è tra i soci fondatori del consorzio ECOLIGHT.

Scegliere prodotti di aziende che hanno aderito a consorzi volontari per il recupero e riciclaggio dei beni è scelta responsabile ed ecologicamente corretta a tutela dell'ambiente e del nostro futuro.

I prodotti che ricadono nel campo di applicazione delle direttive RAEE sono identificati dal simbolo presente simbolo.



DIRETTIVA ROHS 2011/65/UE

Al fine di agevolare il recupero, il riciclo delle apparecchiature elettriche e ad evitare che si accumulino nell'ambiente sostanze pericolose, la comunità Europea ha promulgato la direttiva ROHS. Essenzialmente questa direttiva precisa che:

Fatto salvo quanto stabilito all'allegato 3, è vietato immettere sul mercato apparecchiature elettriche ed elettroniche nuove rientranti nelle categorie individuate nell'allegato 1, contenenti piombo, mercurio, cadmio, cromo esavalente, bifenili polibromurati (PBB) od etere di difenile polibromurato (PBDE) in quantità superiore a quanto previsto all'allegato 2. In Italia la direttiva è stata recepita con D. Lgs. n. 27 del 4 marzo 2014.

ECOLIGHT



Concessionario Marchio IMQ



Partner DIALUX

Associato:



Assil



I dati tecnici indicati nel presente catalogo sono in continua evoluzione. Per verificare l'ultimo aggiornamento tecnico degli apparecchi, consultare il Catalogo elettronico presente sul sito www.beghelli.com

Sul sito sono inoltre disponibili i cataloghi in formato digitale delle varie linee di prodotto che possono comunque essere richiesti in versione cartacea a:

Beghelli S.p.A. - Direzione Commerciale - Via Mozzeghine, 13/15 Valsamoggia Loc.Monteveglio - 40053 BO

Numero Verde
800-626626

© Copyright 2024

Beghelli

BEGHELLI S.p.A. Via Mozzeghine 13/15 - 40053 Valsamoggia loc. Monteveglio
Bologna - Italy - Tel. +39 051 9660411 - info@beghelli.it - www.beghelli.com

231 condizioni generali di vendita

General terms and conditions of sale

1. ORDERS - FINALISATION OF AGREEMENTS

Product purchase orders shall be formulated in writing. Order placement is deemed irrevocable. All collaboration programs, orders, work orders and agreements are considered finalised by the written or verbal confirmation of the Seller or, however, as soon as the invoicing and/or delivery of the ordered products is initiated.

2. VARIANTS AND MODIFICATIONS

After order finalisation, any modification or addition to the content and conditions of the order shall be valid and will become effective only after the Buyer receives a confirmation variant from the Seller. The text of the Seller's confirmation or confirmation variant shall in all cases prevail over any other document. If the Buyer does not intend to accept the conditions that differ from his/her order, he/she must inform the Seller within 20 (twenty) days from the date of confirmation; otherwise, the confirmation variant will be considered fully accepted.

3. METHOD OF ACCEPTANCE

The Seller shall not be held liable for any unaccepted orders or for any failed or delayed delivery of the products part thereof. Acceptance and execution of the order are specifically subject to the availability of the products ordered as well as the absence of circumstances that may affect the availability of the same and the timeliness of their delivery.

4. TERMS OF DELIVERY

The delivery terms communicated by the Seller are purely indicative. Delivery terms expressed in days are normally counted in working days. Any changes to the delivery terms requested by the Buyer must be first accepted in writing by the Seller. Any delay in deliveries, as well as any interruption and/or total or partial suspension of supplies, even if not due to force majeure and/or accidental circumstances, will not entitle the Buyer to compensation for damages and/or to any other kind of indemnity or interest, except for the sole right to cancel the order, provided that the Seller is notified in advance, with at least thirty days before the day of receipt of the registered letter with acknowledgement of receipt sent by the Buyer.

5. FORCE MAJEURE

By way of example, but not limited to, the following are considered cases of force majeure: strikes, lockouts, riots, labour conflicts, fires, natural disasters, impossibility of supplying products, interruptions or difficulties in transport, delays of shipment, lack of raw materials, government acts, authority measures, contractual non-fulfilment by suppliers and, in general, any unforeseeable event that is outside the reasonable control of the Seller. In all such cases, as well as in the event of any accidental circumstances, the Seller reserves the right to suspend and/or delay the delivery of the products and even cancel the orders, even if already confirmed; this will not entitle the Buyer to compensation for damages and/or to any other kind of indemnity, including those for direct, indirect and consequential loss.

6. DELIVERY - TRANSPORT

The goods always travel at the risk and danger of the Buyer, even if delivered carriage paid and/or using a vehicle of the Seller; therefore, the Seller will not accept disputes for any product breakage and/or tampering. The delivery of the products is intended to be carried out at the Seller's headquarters in Monteveglio - Valsamoggia (Bologna) or at third party warehouses with which the Seller has entered into special agreements ("Ex works" condition - Incoterms 2010). Transport costs are borne by the Buyer. The Seller does not accept returns.

7. COMPLAINTS - PRODUCT REPLACEMENT

Any requests for replacement and complaints shall be handled by applying the safeguards provided by the applicable legislation in relation to the specific type of customer, professional operator or consumer. Upon product receipt, the Buyer must check its condition, the quantity delivered and its compliance with the delivery note. Any complaints concerning product quality, quantity or type shall be submitted in writing within 8 (eight) days from the date of receipt of the goods. After this period, without prejudice to the warranty conditions provided for the individual products, no claim can be made regarding the material and quality of the goods, or their condition in general. The Buyer may not, under any circumstances, return the products without the prior written authorisation of the Seller, nor delay and/or suspend the payment of invoices in whole or in part, not even in the case of complaints. If, in the opinion of the Seller, the claim is justified and has been filed within the warranty terms stated in the booklets accompanying the individual products, the obligation of the latter is limited only to the replacement of the nonconforming product in accordance with the delivery terms established for the first delivery. It is, therefore, excluded any right of the Buyer to cancel the order or to obtain any compensation for expenses and/or damages. The right to replace the contested product shall lapse if the product is not diligently stored, kept at the disposal of the Seller, and returned immediately to the place determined by the Seller.

8. APPLICATION OF WARRANTY

The warranty applies only to faults and/or defects in the conformity of the product in relation to the terms and conditions indicated in the declared and/or agreed technical specifications or in case of premature breakage of one of its parts. The validity period of the aforementioned warranty is at least 24 months from the date of purchase, which can be proved by presenting a valid tax document. Luminaires with extended warranties are marked in catalogues or instruction sheets with the number of years of total warranty in conjunction with the letter G (e.g., 5G marking for products with a 5-years warranty). As a general rule, the following extensions apply: emergency luminaires equipped with Lithium Iron batteries (LiFe) and centralised emergency lighting systems benefit from a 5-years warranty, those equipped with Lithium Titanate batteries (LTO) benefit from a 10-years warranty (for all parts, including batteries); EcoDriver or Dimmable luminaires benefit from a 3-years warranty, SmartDriver luminaires benefit from a 5-years warranty (for all parts, including sources). The warranty does not apply in case of tampering, to defects caused by accidental damage of any kind, including during transport and installation, in case of improper use or use in disagreement with the product specifications, in case of negligence in use and maintenance, errors in installation or connection, and installation performed by unqualified personnel or without respecting the state-of-the-art standards. Unless otherwise required by applicable law, the warranty is limited only to the replacement/repair of nonconforming products or parts, according to the delivery terms of the first delivery. All work performed under warranty by the Seller shall be subject to observance of the payment conditions by the Buyer.

9. PRICES

The prices indicated in the Seller's price lists are not binding; therefore, the Seller reserves the right to modify them until the time of delivery of the products. All prices are exclusive of VAT and any other tax charges.

10. PAYMENTS

All payments shall be made, within the terms and in the manner indicated by the Seller, to its headquarters in Monteveglio - Valsamoggia (Bologna) or to the appointed person authorised in writing by the Seller. In case of delay in payment, the defaulting buyer will be obliged to pay the Seller interests on late payment from the date of expiry of the contractual period until settlement, to the extent provided for in Legislative Decree 231/2002, apart from any compensation for any further damages incurred. Failure to comply with the payment terms by the Buyer will give the Seller the right to terminate the corresponding supply contract with immediate effect and to suspend the delivery of all products ordered without the need for any communication, with the consequent right of the Seller to demand the immediate payment of the entire credit as well as to claim compensation for the damages incurred. In case of non-fulfilment and/or worsening of the patrimonial conditions of the Buyer to a degree that may jeopardise the collection of the credit by the Seller, as well as in the event of prolonged delay in payments and/or high total debt exposure (also due to previous uncollected sales), the Seller reserves the right to apply the provisions of art. 1460 and 1461 CC, undertake appropriate precautionary actions and resort to any other form of self-protection permitted; it is further agreed that in such cases the Seller may suspend any and all supplies.

11. LIEN AGREEMENT

The products sold are subject to a lien agreement; therefore, the Seller will retain possession of the goods sold until their price is paid in full. The Buyer, therefore, undertakes to inform third parties of the existence and effectiveness of this Lien Agreement, as well as to safeguard the Seller's rights deriving from the same.

12. SAFEGUARDING – DISPUTES AND JURISDICTION

The invalidity or unenforceability of any of the clauses contained in these general conditions of sale shall not affect, or detract from the validity and enforceability of the other provisions; the Seller and the Buyer undertake to replace any clauses declared ineffective and/or null, or impracticable, with other provisions having similar effects. For any dispute or contestation relating to the interpretation, validity and execution of the order or, in any case, concerning the contracts to which these general conditions of sale apply shall be governed by the Italian Law. The Forum of Bologna shall have exclusive jurisdiction.

Product safety and European Directives

PRODUCT SAFETY AND EUROPEAN DIRECTIVES

Beghelli products are manufactured according to the state-of-the-art standards concerning safety and quality and will not affect, even when used under foreseeable overload conditions, the safety of persons, pets and property, on condition that they are correctly installed and used according to their intended purpose in the recommended environmental conditions and subject to proper maintenance by qualified personnel.

To the extent applicable, the products shall be manufactured in accordance with the requirements of Community Directives 2014/35/EU, 2014/30/EU, 2014/53/EU, 2014/30/EU, 2009/125/CE, 2001/65/CE.

The CE marking affixed to the product and/or packaging and/or any warnings of use accompanying the product attest to the conformity of the product with the aforementioned Directives. Beghelli has its own Technical Archive, available to the competent authorities for possible inspections, containing documentation

demonstrating that the product has been examined to assess its compliance.

Products that do not fall within the scope of the above-mentioned EC Directives comply with the quality standards laid down by the regulations in force and by Directive 2001/95/CE ("General Product Safety Directive"), transposed by Legislative Decree No. 172/2004.

The data contained in this catalogue may be subject to change without notice.

The indications, dimensions, drawings and photos of the products and components are given for informational purposes only and may be modified without prior notice, as they do not constitute pre-contractual information. All products intended to be connected to the mains shall be installed in compliance with the installation standards in force in the country of use, observing the information contained in the Catalogue and/or the relevant instructions supplied with the product itself.

Environmental protection

WEEE DIRECTIVE 2012/19/EU

The quantities of waste from electrical and electronic equipment (WEEE) are rapidly increasing; most of the light sources are included in this category.

The main aim of the directive is to prevent WEEE from being discarded to landfills or incinerators at the end of their life, thereby causing further serious environmental impact. Directive 2012/19/EU, therefore, sought to induce a control mechanism which provides for a controlled end-of-life management of the device by giving priority to its reuse or recycling. In addition, the legislative mechanism promotes design and production concepts that make it easier to dispose of the products in terms of both their disassembly and their materials.

All supply chain participants are invited to make their own contribution, some with regard to the economic aspects, some in terms of activity, so that the spirit of the directive is respected (and the environment is protected).

In Italy, the Directive has been transposed by Legislative Decree No. 49 of 14 March 2014.

THESE ARE THE MAIN OBLIGATIONS FORESEEN

The manufacturer (understood in a broad sense and, therefore, essentially as the person who affixes one's own brand on the goods and who imports them from third countries) is responsible for the costs of disposing of their products at the end of their life.

The consumer is required to guarantee an intelligent end-of-life management of the product by sending it to a specially equipped site, a point of sale or by observing the instructions provided by the manufacturer.

Beghelli, always sensitive to environmental issues, is one of the founding members of the ECOLIGHT consortium.

Choosing products from companies that have joined voluntary consortia for the recovery and recycling of goods is the responsible and ecologically correct choice to protect the environment and our future.

Products falling under the scope of the WEEE Directive are identified by this symbol.



ROHS DIRECTIVE 2011/65/UE

In order to facilitate the recovery and recycling of electrical equipment and to prevent hazardous substances from accumulating into the environment, the European Community has enacted the ROHS Directive. Essentially, this Directive states that:

Without prejudice to Annex 3, the placing on the market of new electrical and electronic equipment falling within the categories identified in Annex 1 containing lead, mercury, cadmium, hexavalent chromium, polybrominated biphenyls (PBB) or polybrominated diphenyl ether (PBDE) in excess of the value indicated in Annex 2, shall be prohibited.

In Italy, the Directive has been transposed by Legislative Decree No. 27 of 4 March 2014.

ECOLIGHT



Concessionario
Marchio IMQ



Partner **DIALUX**

Associato:



Assil



The technical data and images in this catalogue are subject to continuous development and may change without notice. To check the latest technical update of the luminaires, please refer to the electronic catalogue on www.beghelli.com.

Digital catalogues of the various product ranges are also available on the website and can also be requested in hard copy from:

BEGHELLI S.p.A. - Commercial Division - Via Mozzeghine, 13/15 Valsamoggia Loc. Monteveglio - 40053 BO

Freephone Number
800-626626

© Copyright/2024

Beghelli

BEGHELLI S.p.A. Via Mozzeghine 13/15 - 40053 Valsamoggia loc. Monteveglio
Bologna - Italy - Tel. +39 051 9660411 - info@beghelli.it - www.beghelli.com